



Date: 5<sup>th</sup> May, 2014

Shri Sanjeev Banzal,  
Advisor (NSL II),  
Telecom Regulatory Authority of India (TRAI)  
Mahanagar Doorsanchar Bhawan  
Jawaharlal Nehru Marg  
New Delhi-110002

**Subject: Broadband India Forum response to TRAI consultation paper on Allocation & pricing of Microwave Access and Microwave Backbone Carriers dated 28<sup>th</sup> March, 2014**

Dear Sir

At the outset, we wish to thank TRAI for publication of this important consultation paper "Recommendation for allocation and pricing of Microwave Access (MWA) and Microwave Backbone (MWB) RF carriers" dated 28th March 2014.

Broadband India Forum is a non profit non political forum which has been set up to advocate, enhance, expand and usher true value of broadband potential for value addition, so that common citizen of India avail of the advantages of the service in their daily life with ease and affordability. To become the primary advocate for developing an eco system for the delivery of broadband in the country, encouraging e-governance, e-commerce and m-commerce, facilitating content development and aggregation networks, providing a platform to discuss and evolve strategies to achieve the shared aspirations of the industry, providing and promoting the effectiveness of interactivity features and educating the communities about the core strengths and competencies of the Broadband Access Technologies.

Following the new developments in the cellular network pertaining to rapid growth of data traffic and the arising subsequent need for increasing the backhaul capacity, this consultation paper assumes significant importance. More particularly, the decision to include new high frequency bands in this paper, was extremely well received by all our members comprising of the leading operators viz. Vodafone, Airtel, etc as well as the leading vendors of the Point-to-point and Point-to-Multipoint and those of E band and V band viz. Siklu, Ericsson, Cambridge Broadband etc and also by those who are exclusively designing chipsets for these new " Millimeter wave technologies " viz. Broadcom . The entire ecosystem feels that whether it is 3G/4G small cells or WiFi offload, there is also a growing interest in using E Band ( 71-76Ghz, 81-86 Ghz ) as well as 60GHz unlicensed (in many parts of the world) spectrum for high capacity backhaul. Keeping in view the obvious congestion and the constraints in data carrying capacity of traditional legacy Microwave bands, we believe that low cost, small form factor, high capacity E-band and V band systems makes India potentially as one of the world's largest markets for such next-generation( NG ) wireless backhaul systems which can leapfrog the laggard optical fibre network thereby making India fully data centric. Your initiative in regulating and streamlining this sector we believe, is likely to bring about a big increase in revenue for operators and thereby to the government as well, besides kickstarting even local manufacturing in this sector.



After holding a Round Table Discussion with the stake holders on 16 April 2014 and there after consulting all our members and after several rounds of detailed discussions with them, we are enclosing the following documents:

1. BIF response to the TRAI Consultation Paper on Allocation & Pricing of MWA/MWB carriers and
2. White paper on “ Millimeter Wave Technologies “ ( E band, V band & PMP technologies ).

In case of any clarifications, kindly feel free to contact us.

Thanks

Yours sincerely,

A handwritten signature in blue ink, which appears to read 'Anil Prakash', is written over a horizontal line.

**Anil Prakash**  
Secretary General  
Broadband India Forum  
Suite 304, Gagan Deep  
12, Rajendra Place  
New Delhi- 110008, India  
Mobile +91-98111 55846,  
Tel: +91-11-2575 7128  
Fax: +91-11-25757129  
Skype ID:anil.prakash  
email. [anilprakash@yahoo.com](mailto:anilprakash@yahoo.com) , [anilprakash@gmail.com](mailto:anilprakash@gmail.com)

Encl: a/a

## **BIF RESPONSE ON TRAI CONSULTATION PAPER FOR MICROWAVE ACCESS AND MICROWAVE BACKBONE CARRIERS**

### **CHAPTER-IV: ISSUES FOR CONSULTATION**

Q1. How many total Microwave Access and Backbone (MWA/MWB) carriers should be assigned to a TSP deploying:

- a. 2G technology only.
- b. 3G technology only.
- c. BWA technology only.
- d. Both 2G and 3G technologies.
- e. 2G and BWA technologies.
- f. 2G, 3G and BWA technologies.

Please give rationale & justification for your answer.

#### **BIF Reponse:**

**Existing DOT guidelines for allocation of MWA and MWB RF carriers for BWA services should prevail. i.e. % of AGR for MWA carriers and link-by-link for MWB carriers.**

**In general, total number of carriers to be assigned to a TSP shall be based on a number of factors viz. aggregate traffic, network topology, growth/spurt in data traffic, number of existing players, type of technology deployed, the quantum of access spectrum allocated, etc. Also given the fact that the spectrum usage charges are significantly high, the number of carriers demanded by a TSP will be for optimum utilisation only.**

**Taking into account the present utilization of the assigned carriers in various service areas, we propose 8 MWA carriers in Metro, 4 carriers in A circles, 3 in B&C circles for the existing operators. The requirements may further increase with evolution of new advanced technologies requiring additional carriers.**

**As regards the MWB carriers, since they are deployed to carry backhaul from city to city, 2 carriers will suffice for A,B and C circles to care of the basic minimum requirements for interference free network.**

BROADBAND INDIA FORUM

The contents of this document are the exclusive privilege of the forum and shall not be replicated in any form without the exclusive approval of the forum

Q2. How many MWA/MWB carriers need to be assigned to TSPs in case of 2G, 3G and BWA at the start of their services[ i.e. at beginning of rolling of services] Please justify your answer.

**BIF response:**

**At the beginning of the service, as per existing DOT guidelines, it should be :**

**-4 carriers in Metros & A circles**

**-2 carriers in B & C Circles.**

**However with the spurt/growth in data, the network topology deployed by the operator and with the overall focus on promotion of broadband, this number may be required to be reviewed.**

Q3. Should excess spectrum be withdrawn from existing TSPs?

**BIF response:**

**Since the spectrum usage charges are significantly high, and spectrum allocation is usually made after proper justification, it is understood that the given spectrum shall be optimally utilised by the TSP. Also due to huge spurt/growth in data both for 2G and for 3G networks, and given the operators commitment to the NTP and the BB policy of the GOI , the issue of spectrum withdrawal just does not arise.**

Q4. If yes, what should be the criteria for withdrawal of excess allocation of MWA and MWB carriers, if any, allocated to the existing service providers?

**BIF response:**

**No comments-Since answer to Q4 is NO.**

Q5. What should be the preferred basis of assignment of MWA/MWB carriers to the TSPs i.e. 'exclusive basis assignment' or 'link-to-link based assignment'?

**BIF response:**

**For MWA , it should be on a exclusive basis and for MWB it should be on a link-by-link basis. We wish to add that for MWB, the assignment on link by basis is justified since the available number of carriers are limited for assignment (only 8 in 6 GHz and 5 in 7 GHz) to large number of TSPs in any Service Area and cannot be assigned on exclusive basis. Moreover links deployed are few in**

numbers being mostly used for inter-city backhaul thus the coordination by WPC will be easy for interference and subsequent assignment to various operators.

**For spectrum in the 10.5, 26, 28GHz bands used**

- For PTP link-by-link basis is preferred
- for PMP, exclusive basis is preferred

Q6. In case 'exclusive basis' assignment is preferred, whether MWA and MWB carriers should be assigned administratively or through auction. Please comment with full justifications.

**BIF response:**

No auction. In fact, we suggest that MW spectrum should be bundled along with access spectrum as a single package. Referring to Table 3.1 of the TRAI paper, we find that MWA carriers are available in plenty (out of the total 2090 carriers, only 810 carriers have been assigned and 1280 carriers are available with WPC). The availability can be further increased if the new frequency bands namely 26 GHz, 28GHz, 32 GHz and 42 GHz in 6-42 GHz range are explored which are used in other countries for MWA but not being assigned for MW links in mobile network in India.

TSP after winning the Access Spectrum in auction need the MWA and MWB carriers immediately to roll out the services without any delay. Hence MW carriers should be administratively assigned along with Access Spectrum as a critical resource to rollout the access services to the customers.

Q7. In case 'link-to-link basis' assignment is preferred, how the carrier assignment for different links should be carried out, particularly in nearby locations?

**BIF response:**

Carrier assignment for link to link basis has been recommended only for MWB. This requires coordination by WPC for any interference with the existing operating links of other TSPs. The operator is required to provide the deployment details like the Geo coordinates of the connected sites, the link distance, power transmitted and the frequency spot to be deployed etc. WPC checks with the existing data base of other operators in nearby locations for any overlap/interference analysis and accordingly assigns the link. In case of any interference issues, the solutions like use of different polarisation, alternate link paths etc are proposed.

Q8. Considering the fact that different TSPs may require additional

BROADBAND INDIA FORUM

The contents of this document are the exclusive privilege of the forum and shall not be replicated in any form without the exclusive approval of the forum

## BIF RESPONSE ON TRAI CONSULTATION PAPER ON MWA/MWB CARRIERS

carriers at different point of time, what should be the assignment criteria for allocation of additional carriers for MWA and MWB?

### **BIF response:**

As mentioned in response to Q1, the criteria for additional MWA will largely depend on the additional BTS/BSC/RNC sites to be installed for coverage & capacity requirements to meet the growing voice/data traffic and introduction of new generation technologies like LTE/LTE-A. This will need more MWA carriers to link the newly built sites especially in CBD/dense areas to connect to the core network. Other limitations like frequency reuse to avoid interference, mobile network density/ hub density and fibre penetration will also be important. Finally the TSPs requiring additional carriers must justify his requirement on these criteria.

Q9. How can it be ensured that spectrum carriers assigned are used optimally and the TSPs are encouraged to move towards the OFC?

### **BIF response:**

Since the spectrum usage charges are significantly high, and spectrum allocation is usually made after proper justification, it is understood that the given spectrum shall be optimally utilised by the TSP. Lack of availability of OFC at cell sites/aggregation points and across the entire service area is a barrier. Government is requested to make OFC available across the city at all cell site locations. Availability of OFC at reasonable prices would encourage TSPs to switch over.

Fibre rollout being expensive and a slow process due to ROW permissions, etc. the fibre cannot be expanded at the pace of wireless networks. With the growing number of wireless sites actual increase in % of fibre pop will take substantial amount of time and cannot be considered today. The challenges in Fibre laying like road digging by other agencies, widening of roads in urban areas, shifting of OFC due to Metro tracks in major cities and high maintenance costs are some of the barriers which discourage going the Fibre way. However many TSPs are already on the job to replace the MWB links with Fibre wherever feasible and economical.

Q10. Should an upfront charge be levied on the assignment of MWA or MWB carriers, apart from the annual spectrum charges?

### **BIF response:**

**No upfront charges. Only annual spectrum charges.**

**The entire network (access and backhaul) is an infrastructure, just like roads, and its well-being promotes the economy. Therefore it is in the regulator's interest to allow this infrastructure to**

BROADBAND INDIA FORUM

The contents of this document are the exclusive privilege of the forum and shall not be replicated in any form without the exclusive approval of the forum

function the best it could. Since one of the main bottlenecks of this infrastructure happens to be the backhaul, then the regulator should give the TSPs the motivation to optimize the backhaul of their network and use his charging policy for that. This includes both the annual spectrum charge and any additional charge if any. By doing that the regulator should note that the TSPs have to invest money in deploying equipment to utilize these carriers.

There is a view on Spectrum management that claims that the main asset in great need is the Access Spectrum (2G/3G/4G), so this is where regulators need to focus on one hand by allocating more and more spectrum (white space, reverse auction), and on the other hand this should be the main tool to charge the operator the royalties for the revenues generated from its use. All other spectrum needs, to build a good and efficient infrastructure for that access spectrum, should be supplied by the regulator at minimum charges (just cover the cost) so that infrastructure will help the TSPs generate more revenues which will enable to generate more revenues to the government

Also it must be borne in mind that all the TSPs have already paid huge spectrum charges for the access spectrum through the auction route.

Q11. What should be the pricing mechanism for MWA and MWB carriers?

Should the annual spectrum charges be levied as a percentage of AGR or on link-by-link basis or a combination of the two?

**BIF response:**

**The prevailing pricing mechanism should prevail. For MWA carriers, it should be based on % of AGR and for MWB carriers, it should be based on link-by-link method.**

Q12. In case of percentage AGR based pricing, is there any need to change the existing slabs prescribed by the DoT in 2006 and 2008?

Please justify your answer.

**BIF response:**

**Yes. In the light of the steep spectrum usage charges for the access spectrum already paid by the TSP and the significant spectrum charges for the microwave, there is a need to review the price slabs and make it more reasonable.**

**Further a lower uniform rate as % of AGR per carrier of 28 MHz bandwidth should be considered since the SUC is supposed to be marginal to only cover the spectrum management costs. This uniform rate can be prescribed as 0.05% of AGR per carrier of 28MHz bandwidth (paired) for both MWA and MWB. The License fee as % of revenue takes care of the increase in revenue and there is no justification for higher SUC charges.**

BIF RESPONSE ON TRAI CONSULTATION PAPER ON MWA/MWB CARRIERS

Q13. In case link-by-link based charging mechanism is adopted then:

(a) Should the spectrum be priced differently for different MW spectrum bands (6GHz/7GHz/13GHz/15GHz/18GHz/21 GHz/26 GHz/28GHz/32GHz/42 GHz etc)? If yes, by what formula should these be charged?

**BIF response:**

**MWB (6 & 7 GHz) should be charged on the AGR basis as is being currently done on the basis of total bandwidth assigned on non-exclusive basis, since link by link charging based on formula will lead into complications like verification of the total number of links , distances etc by WPC thus may lead to ambiguity/anomalies. The other bands namely 13/15/18/21/23 GHz should also continue on the AGR basis as mentioned earlier. However there is an absolute need to review the pricing below the rates specified in DoT order of 2002 since the operators are already paying huge spectrum usage charges which keep increasing with the ever growing revenues along with the License fees as percentage of AGR, thus resulting in double financial impact to the TSPs.**

(b) What are the factors (viz as mentioned in para 3.22), that should appear in the formula? Please elaborate each and every factor suggested.

**Please refer response in (a) above**

Q14. Should the option of assignment of MWA carriers in all the spectrum bands in 6-42 GHz range be explored in line with other countries? What are the likely issues in its assignment MWA carriers in these additional spectrum bands?

**BIF response:**

**Yes-it should be explored. Harmonising with common practice in other countries will lead to benefits to all parties. You may add bands in 32 and 42 GHz also. We do not anticipate any issue in the assignment of these bands as they are already in use by other countries. BIF response for these additional bands in 10.5, 26 and 28 Ghz is enclosed herewith.**

BROADBAND INDIA FORUM

The contents of this document are the exclusive privilege of the forum and shall not be replicated in any form without the exclusive approval of the forum



Q15. In your opinion, what is the appropriate time for considering assignment of MWA carriers in higher frequency bands viz. E-band and V-band?

**BIF response:**

**E-Band and V-Band are used in growing numbers by TSPs, ISPs and enterprise customers all over the world, including fiber rich countries like Korea and Japan. LTE networks and high speed WiFi standards have increased the use of E-Band and V-Band.**

**Having one of the most dense telecom deployments in the world, there is every reason to start using these frequencies in India immediately. More than that, given the shortage in access spectrum in India, and the absence of residential access, WiFi offload can have a key role in India, and these frequencies can play an important role in backhauling these offload networks. E-Band can also help in rural places if by using E-Band TSPs may be able to free up RF carriers in lower frequencies that can be used in rural places for longer hops.**

**With increase in 3G and now with new rollouts on 4G( LTE ) and with rapid increase in data traffic , operators now require between 20-100 mbps per cell site . The common preferred architecture is ring based to bring the networks to high availability. Moreover, the nature of the traffic where video and jumbo packets are used more commonly reduce the efficiency of header compression techniques. The WiFi/3G/4G traffic requires high capacity rings which can be met by V band and E band frequencies.**

**The traditional legacy MWA carriers in the 6-42 GHz band are expected to get increasingly saturated/congested and are therefore incapable of carrying such large backhaul capacity requirements for LTE backhaul. Hence, MWA carriers in E-band and V-band are required to be allocated IMMEDIATELY to ensure good quality of service, high throughput, high network availability for new bandwidth hungry applications and excellent “ Customer experience “ and customer satisfaction.**

Q16. Should E-band be fully regulated or there should be light touch regulations?

**BIF response:**

**E-Band should be lightly licensed, as in many places in the world.**

**The AGR method cannot be used for E-Band for two reasons:**

- **In E band there are not enough channels to give to operators on an exclusive basis. Due to the extremely wide channels needed in E-band, requiring 2 to 4 channels of 250 MHz each, AGR based scheme cannot be practically implemented as for lower microwave bands where each operator is assigned specific spots in a circle/LSA on exclusive basis. With 4.75 GHz of spectrum, allowing for 1000 MHz channels (as required by many**

vendors) will allow only 4 independent channels per circle, and working with 500 MHz will allow for 9 independent channels.

- Since E-Band links are going to be implemented in urban short overlays over the existing microwave structure, initial deployments will contribute only to part of the operator revenues, therefore AGR based pricing cannot be practically implemented, as it will result with a too high cost per link when one calculates the circle AGR versus the number of links to be deployed.

Per link licensing seems to be the only way to benefit from the high re-usability of the spectrum. Low pricing is needed in order to encourage the usage of this spectrum. The Light Licensing process has to facilitate for the following requirements:

- Fast and easy online access to register the link
  - Registration of the link
  - Interference analysis (on line!)
  - Online payment
- Easy, online access to issue import licenses
- Channel allocation will be done by the system
  - The system will try to populate one channel, or set of adjacent channels, and only when interference is detected will allocate the next (set of) channel.

To attract the TSPs to use this band , the initial pricing of the band should be kept as low as possible. It is even suggested that initially the pricing should be such that it covers only the administrative costs. Also automatic SACFA clearance should be permitted.

A detailed chapter on Pricing of E band and Light Licensing approach is attached.

Q17. What charging/pricing mechanism would be appropriate for these bands?

**BIF response:**

**E-Band**

**Link-by-link (with light licensing) charges for E-Band (See Annex 2)**

- Per link policy ("light License") where each 2 X 250MHz channels ("spot") will be around 1,500 Rupees annually.
- During 5 year transition period:
  - First 2 years during which frequency will be charged at 80% discount.
  - Further 3 years during which the operators will receive 50% discount.

BROADBAND INDIA FORUM

The contents of this document are the exclusive privilege of the forum and shall not be replicated in any form without the exclusive approval of the forum

### **V-Band**

**We recommend allocation of the whole 57-64GHz band (beyond what was proposed in IND-80) in order to offer a wide band as existing in other countries , with free of charge pricing, as appropriate for unlicensed bands. Alternatively, it can be treated as lightly licensed same as the E-Band.**

Q18. Apart from Q1-Q17, stakeholders are requested to bring out any other issue, which needs to be examined, with justification.

#### **BIF response:**

**Two other bands are requested for consideration viz.**

**V band -to effectively cater to small cell requirements in urban/dense urban areas for requirements of high capacity dense networks in 57-64Ghz band. There is an urgent need to assign carriers in V band for rollout of high capacity backhaul networks to cater to high throughput needs, due to rollout of future technologies like LTE.**

**PTMP : A separate chapter has been added here to permit allocation and licensing of PTMP ( point –to-multipoint) technologies viz. LMDS etc in 10.5, 26 and 28 GHz band . The competent authority is requested to kindly examine these suggestions also.**

**(a) WPC should examine the availability of spectrum in bands <10 GHz for MWB requirements especially for rural areas due to limited availability of carriers in 6 and 7 GHz. ( there are only 5 carriers in 7 GHz and 8 in 6 GHz, most of them being held by BSNL)**

**(b) Opening of KA band (satellite band) to deploy advanced cellular networks in remote locations since there is capacity crunch in the existing C & KU bands.**

**Keeping in view the burgeoning data traffic and the meteoric rise of smartphones usage in the cellular network, the operators are struggling to keep pace with the increasing traffic needs for backhaul. As already discussed, optical fibre , though desirable at cell sites, is scarcely available for reasons quite well known. Also traditional/legacy microwave bands are getting more and more congested and despite the availability of “ new “ high frequency bands viz. E and V bands, it is obvious that the market needs to be thrown open to satellite transponder bandwidths for the purpose of traffic backhauling. A case in point is the high bandwidths possible using Ka band which till date is unregulated.**

**To make the high capacity satellite bandwidths available directly to the end user without having to go through the bureaucratic maze of satellite policy maker, satellite communication regulator and satellite service operator , more liberalised measures are desired viz. Open Sky Policy . This will ensure a fair degree of transparency, fair competition, choice of any satellite ( GEO, MEO/LEO), choice to go to any satellite operator ( foreign or indian ) and will enable**

**BROADBAND INDIA FORUM**

The contents of this document are the exclusive privilege of the forum and shall not be replicated in any form without the exclusive approval of the forum

**availability of choice of transponders with high capacity, leading to availability of huge bandwidths for backhauling at low backhauling costs .**  
**BIF recommends that TRAI to get involved in the preparation of the new satellite communication policy ( National Satcom Policy-2014 ) and publish a consultation paper inviting comments and opinions of all stakeholders from the industry."**

## **E-Band Regulation & Pricing**

### **Executive Summary**

The motivation to use E-band in India seems stronger than in the rest of the world due to the special conditions of the Indian Telecom market, that include: very high density in the urban areas, urgent need to increase the capacity of data services (mobile broadband), the general shortage of microwave spectrum for backhaul and the need to allocate such spectrum to new operators and rural deployments.

The unique characteristics of the Eband spectrum: The short range (up to 1Km, in the high intensity rain zones of India while in most of the western world it is up to 2.5Km), the high spectral reuse in dense urban areas, and the ability to achieve small form factor, coupled with low cost equipment make it ideal for last mile urban deployments, subject to the existence of an appealing business case to encourage usage of new equipment in this band.

The aggressive price reduction of microwave equipment, mainly driven by the large Indian Telecom market, has made the charges for the wireless spectrum/ licenses as a major burden. Most of the countries that have opened the E-band spectrum, have done so with a pricing policy in which the cost per MHz is 200 to 400 times less than in the 8-38GHz band!

The major financial benefit to the government from encouraging the use of E-band lies in the large potential of increasing the overall operator revenues, and hence the revenue share on account of license fee, spectrum charges (from other spectrum allotments) and other levies that are derived from them, and not from direct revenue from this unused/ virgin spectrum, which presently is bringing no revenue.

#### **What is expected?**

BROADBAND INDIA FORUM

The contents of this document are the exclusive privilege of the forum and shall not be replicated in any form without the exclusive approval of the forum

- **Per link policy where each 2 X 250MHz channel (“spot”) will be around 1,500 Rupees annually.**
- **During 5 year transition period:**
  - **First 2 years during which frequency will be charged at 80% discount.**
  - **Further 3 years during which the operators will receive 50% discount.**

An E-Band Spectrum Policy that will encourage the use of this technology by opening it up at a minimal charge (if not completely free!) with a technology neutrality specification that will enable a multi-vendor market that will drive high competition, low prices, and high deployment rates that will accelerate the mobile broadband usage in India.

## **E-Band Spectrum**

Mobile operators worldwide are turning to the E-band spectrum specifically the 71-76 GHz, 81-86 GHz bands to enhance and streamline their backhaul networks. Due to the large allocated spectrum and propagation characteristics at these frequencies, wireless backhaul systems operating at these frequencies, also referred to as millimeter-wave wireless systems, can provide up to multi-gigabit capacities for relatively short distances of a few kilometers. The antennas used in E-band frequencies are highly directional and together with the propagation limitations, wireless systems operating at the E-band frequencies are highly focused, point-to-point “pencil beam” links allowing a much higher reuse of the same frequency in a given area.

Utilizing the E-band spectrum, mobile operators can better design their backhaul, allowing a more efficient frequency plan. Mobile operators are building a layered backhaul network where the 6-38 GHz spectrum will be used for relatively long-haul transmission and the E-band spectrum for high-capacity, short-haul links particularly in urban and sub urban deployments. Doing so, mobile operators are able to increase their backhaul capacity according to their increasing needs without causing frequency congestion. This allows the mobile operators to introduce new and advanced mobile broadband services to the consumers. The consumers on the other hand are enjoying the true experience of mobile broadband at their fingertips.

The mm-wave (E-Band) band, with two 5GHz blocks of spectrum allocated at 71-76GHz and 81-86GHz, benefits from the large channel bandwidth available in this frequency, with typical channel bandwidth of 250MHz, and channel aggregation that is allowed up to the entire 5GHz of available spectrum. As the operating frequency increases, the propagation of a radio wave transmitted from a given antenna becomes more directional. In a dense environment where many links are expected to operate in close proximity, this translates to better spatial isolation between links, and practically zero interference. Recognizing the minimal risk of interference when operating in this band, regulators worldwide adopted a new, 'light licensing' paradigm. Under this 'light licensing' paradigm link licensing is based on quick (mostly online) registration, extremely low spectrum license fees, and technology neutrality to duplexing (TDD/FDD), channel aggregation and modulation beam. The main limitation imposed on this band is the requirement for a minimum

BROADBAND INDIA FORUM

The contents of this document are the exclusive privilege of the forum and shall not be replicated in any form without the exclusive approval of the forum

antenna gain (38/43dBi in EU/US) in order to maintain a directivity level that will ensure the spatial diversity.

The high sensitivity of this band to rain attenuation, limits the practical ranges of equipment operating in this technology to 2 – 2.5 Km (and even less than 1 Km in monsoon areas), making it ideal for high density broadband deployments. Channel aggregation and advanced modulation techniques can scale this technology to 5Gbps and more, while maintaining small form factor and low power consumption.

Commercial equipment working in this band has been available in the last decade, providing GigE wireless links, mainly for enterprise and vertical applications, but at costs ranging from above \$50K just a few years ago, to \$20K recently.

## **The Motivation for E-band in India**

Allocating the E-band spectrum for use in India will generate additional revenues to the Government of India:

- **Revenues from new mobile broadband data services:** Allocating and utilizing the E-band spectrum will enable mobile operators to offer and provide to their customers a wide variety of mobile broadband services, especially in dense urban areas. These services will generate new and significant additional revenues to the mobile operators which in turn will pay the Government of India a percentage of these revenues as agreed in the terms of the license fee and other levies, including enhanced charges for access and other microwave spectrum. The table below shows the numbers (rupees in crores) for the first quarter of 2011. It is evident that any increase in revenues contributes more than 10% (close to 15% in the Metro and A circles) in license fees.

BIF RESPONSE ON TRAI CONSULTATION PAPER ON MWA/MWB CARRIERS

|                       | GR -<br>Gross Revenue | AGR -<br>Adjusted GR | License Fees |             | Spectrum Charges |             |
|-----------------------|-----------------------|----------------------|--------------|-------------|------------------|-------------|
| Circle type           |                       |                      |              |             |                  |             |
| Metro                 | 5,900                 | 3,682                | 371          | 10.1%       | 181              | 4.9%        |
| A                     | 11,489                | 8,391                | 839          | 10.0%       | 445              | 5.3%        |
| B                     | 10,614                | 7,734                | 621          | 8.0%        | 366              | 4.7%        |
| C                     | 3,672                 | 2,728                | 164          | 6.0%        | 126              | 4.6%        |
| <b>Total (crores)</b> | <b>31,674</b>         | <b>22,535</b>        | <b>1,994</b> | <b>8.8%</b> | <b>1,118</b>     | <b>5.0%</b> |
| <b>(\$M value)</b>    | <b>6,694</b>          | <b>4,762</b>         | <b>421</b>   |             | <b>236</b>       |             |

Charges in Crores of rupees for the Quarter ended in March 2011

- Revenues from an unused spectrum:** Allocating the E-band would lead to the utilization of a band which is presently unused / virgin and thus brings “zero” revenues to the Government of India. Its utilization would bring reasonable revenues for its usage (even at nominal spectrum charges).

Allocating the E-band spectrum in India will facilitate data hungry mobile broadband services while contributing to release some spectrum in conventional lower microwave bands, which in turn would enable additional advanced telecommunications and data services to rural areas in India as well.

- Enabling mobile broadband data services:** With the dramatically increased capacity requirements by modern data services and increase of the density of the cell-sites deployed in 3G and 4G networks mobile operators are turning to the 71-76 / 81-86 GHz E-band spectrum to increase their backhaul capacity while introducing new and advanced mobile broadband services to the consumers. With the astonishing large numbers of mobile subscribers that are added each month, it is important that mobile operators will have the entire necessary spectrum to plan their backhaul network to provide adequate solutions to the near and long term challenges. As we can see below, the number of broadband subscribers is still very low, and is expected to dramatically increase and surge network backhaul capacity requirements because of subscriber numbers and various new applications.

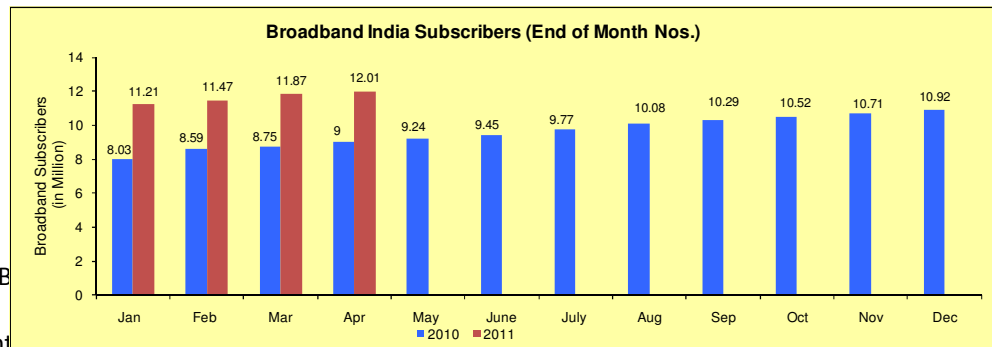

BROADB

The con

in any form without the exclusive approval of the forum

- **Improving the strength to the Telecom Operators:** In an era of falling ARPU's, data and VAS are the main source of increasing operator revenues. This kind of services is, and will be highly dependent on adequate capacity of networks, including backhaul capacity.

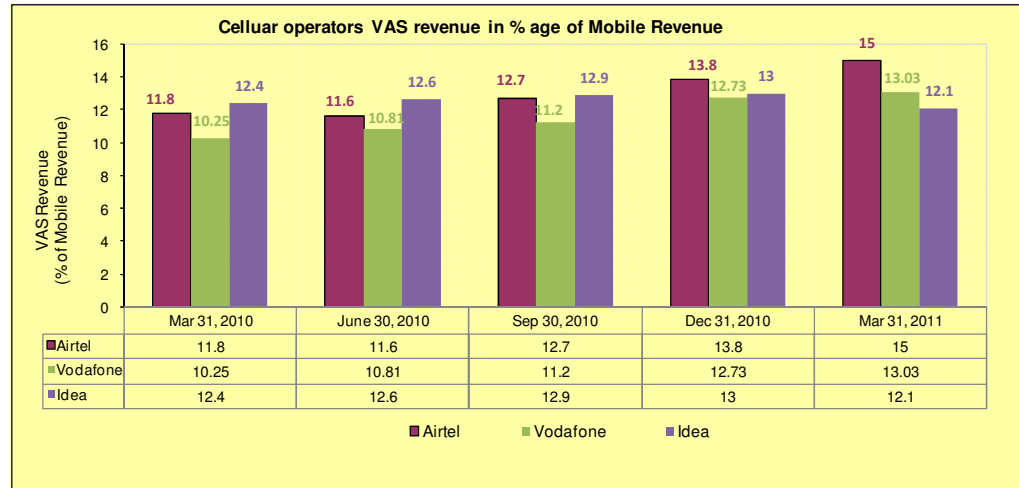

- **Coping with the spectrum congestion:** The increasing number of wireless backhaul links together with the scarcity of available spectrum is eventually leading to a congestion of the microwave spectrum even to a point where it will no longer be available for new operators, new links or allocations. Due to the large allocated spectrum and propagation characteristics of the 71-76 / 81-86 GHz E-band, wireless backhaul systems operating at these frequencies can provide up to multi-gigabit capacities for relatively short distances of a few kilometers with a much higher reuse of the same frequency in a given area.
- **Contribution for telecommunication and data services in rural India:** New mobile operators which are making an effort to bring broadband services to the rural areas in India have limited 15-18 GHz spots as these are taken by the established operators. Designing and implementing a backhaul network which uses the E-band spectrum will allow a more efficient distribution of the 15-18 GHz spots amongst the established and new operators which is vital for rural deployments.

## **E band Pricing**

Since E-Band links are going to be implemented in urban short overlays over the existing microwave structure, initial deployments will contribute only to part of the operator revenues, therefore royalty based pricing cannot be practically implemented, as it will result with a too high cost per link when one calculates the circle AGR versus the number of links to be deployed. **The bottom line is that E-Band links cannot be priced on royalty basis, even at very low percentage.**

The contents of this document are the exclusive privilege of the forum and shall not be replicated in any form without the exclusive approval of the forum



The current per-link pricing scheme enforced in India is calculated according to the following formula such that a 28 MHz channel, short range (up to 5 km) link would cost 288,000 Rupees (~US\$ 5,760):

$$R = M \times W \times C$$

Where:

- **M** – Constant multiplier depending on the distance of the link. The shorter the link the small M is (for example: M=1200 for links up to 5 Km and M=2400 for links up to 25 Km). **We suggest M value of 600 for links of up to 2Km.**
- **W** – Weighting factor decided by the adjacent channel separation of the channeling plan (for example: W=30 for adjacent channel separation above 2 MHz and W=120 for adjacent channel separation greater than 7 MHz but less than or equal to 28 MHz (since from 2MHz to 28MHz W was increased by a factor of 4, a similar proportionate factor when going from 28MHz to 250MHz would be 2.55). **We suggest W=360 for a 250MHz Channel**
- **C** – Number of RF channels used. **C= 2 for 500MHz TDD or 250MHz FDD systems and 8 for 1000MHz FDD systems**
- **E** – We propose a new correction factor, based on the re-use and spectral efficiency (as detailed in Annex 8a - Method 1) and **suggest setting it at 1/300.**

Taking these factors together the per-link pricing scheme suggested for the E-band spectrum is as follows:

- **500MHz TDD:  $R = M \times W \times C \times E = 600 \times 360 \times 2 / 300 = 1,440$  (say 1,500) Rupees (~US\$30)**
- **1000MHz FDD:  $R = M \times W \times C \times E = 600 \times 360 \times 8 / 300 = 5,760$  (say 6,000) Rupees (~US\$120)**

If we perform a “sanity check” according to method 2 in the previous section, we conclude that the same 2\*250MHz channel should cost 1,350 Rupees which is along the same numbers as suggested here.

## **Global Pricing Models and Methodologies**

### **Method 1 – Carrier Value Perspective [bits/Hz/area]**

BROADBAND INDIA FORUM

The contents of this document are the exclusive privilege of the forum and shall not be replicated in any form without the exclusive approval of the forum

BIF RESPONSE ON TRAI CONSULTATION PAPER ON MWA/MWB CARRIERS

Basically we pay for the number of bits we provide in a certain area (modeled by distance and angle). The following factors should then affect the licensing fees / spectrum charges of the E-band spectrum:

- **Typical spectral efficiency:** In the E-band spectrum there are two bands of 4.75 GHz of continuous spectrum in each of the 71-76 GHz and 81-86 GHz frequency bands which are divided into large 250 MHz channels which can even be aggregated. The available spectrum together with the large channels allows achieving high data rates while using low modulation states as limited by the high frequency. As such, typical E-band wireless systems that are available in the market today have a spectral efficiency of upto 2 bits/sec/Hz. In comparison, traditional microwave bands where typical channel size is 28 MHz, high data rates are achieved by using high modulation techniques and XPIC antenna technologies. As such, wireless microwave has a spectral efficiency of 7 bits/sec/Hz (2X7 bits/sec/Hz including the XPIC).
- **Typical Link Distance:** The propagation characteristics and rain fading of the E-band spectrum result in an effective, link range of about 1 Km. For comparison, the typical link distances of lower frequencies (15 GHz or 18 GHz) are 10 to 15 Km on average as the free-space-loss and rain attenuation are less significant in these frequencies.
- **Re-Use Factor:** The highly directional, “pencil beam” propagation characteristics of E-band wireless systems mean that operators can plan and deploy networks with an extremely high degree of frequency reuse, minimal frequency coordination and deploy links very close to one another with minimal interference concerns. Due to antenna transmission patterns (beam width 2-5 times lower) we can assume a re-use factor that is around 3 times higher in E-band compared to traditional microwave bands (this is without taking propagation into account since it is factored into the link distance). The above mentioned factors are summarized in the table below:

| Band      | Frequency [GHz] | ”contamination” Factor <sup>1</sup> [Deg] | Spectral Efficiency [Bits/second/Hertz ] | Link Distance [Km] |
|-----------|-----------------|---|--|--------------------|
| Microwave | 15, 18, 23      | 3   | 7 x 2 (XPIC)                             | 15                 |
| E-band    | 71-76, 81-86    | 1   | 2  | 1                  |

$$Cost\ Multiplier = \frac{3 \times 7 \times 2 \times 15\ (15, 18\ GHz)}{1 \times 2 \times 1\ (E - band)} = \frac{630}{2} = 315$$

Taking into account channel sizes we get to the conclusion that a **2 X 250 MHz E-band channel should be 33 times lower than a 2 X 28MHz microwave channel**, which is very much in line with the 20-40 range we find in other countries.

BROADBAND INDIA FORUM

The contents of this document are the exclusive privilege of the forum and shall not be replicated in any form without the exclusive approval of the forum

**Method 2 – Fees as per Area covered/ affected by link**

Another way to consider the license fee per link, is to see what is the typical area one link (and therefore one annual fee) can cover, and then estimate how many E-Band links can coexist in the area covered by a link in conventional microwave bands, and therefore generate multiple license fees.

**Number of E-Band links in one microwave link area (in conventional bands)**

| Fmin     | Fmax                       | Fave | Θ   | R   | S            | Per link price                            |
|----------|----------------------------|------|-----|-----|--------------|---|
| 71       | 76                         | 73.5 | 1   | 1.5 | 0.0196 Sq-Km | 288000 WPC formula for 28MHz Channel      |
| 15       | 23                         | 19   | 3.9 | 15  | 7.5956 Sq-Km | 744 Target 250MHz Channel a to area ratio |
| Θ        | Antenna 3 db angle         |      |     |     | 386.84       |   |
| R        | Link effective range       |      |     |     |              |   |
| S (area) | $\pi * R^2 * \Theta / 360$ |      |     |     |              |   |

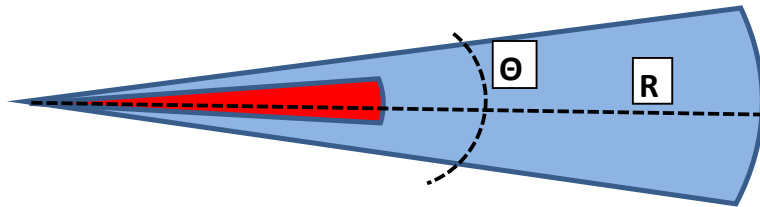

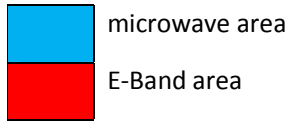

According to the calculation above, the per-link annual cost of an E-Band link (2\*250MHz) should be around 750 Rupees

### Annual Frequency Costs in foreign countries

| Frequency (GHz)          | 15                     |                         | 23                    |                        | 38                    |                       | 71-76/81-86        |                       |                       | 38 (56MHz) to E-band (500MHz) ratio |
|--------------------------|------------------------|-------------------------|-----------------------|------------------------|-----------------------|-----------------------|--------------------|-----------------------|-----------------------|-------------------------------------|
|                          | 28                     | 56                      | 28                    | 56                     | 28                    | 56                    | 250                | 500                   | 1000                  |                                     |
| India <sup>(1)</sup>     | \$6,300                |                         | \$6,300               |                        |                       |                       | \$30               | \$60                  | \$120                 | 215                                 |
| USA                      | \$230                  | \$230                   | \$230                 | \$230                  | \$230                 | \$230                 | \$7.5              | \$7.5                 | \$7.5                 | 30                                  |
| UK                       | \$1650<br>(£1,060)     | \$3290<br>(£2,120)      | \$1150<br>(£740)      | \$2300<br>(£1480)      | \$1000<br>(£640)      | \$2000<br>(£1,280)    | \$80<br>(£50)      | \$80<br>(£50)         | \$80<br>(£50)         | 25                                  |
| Australia <sup>(2)</sup> | \$2690<br>(A\$2,630)   | \$5380<br>(A\$5,260)    | \$2690<br>(A\$2,630)  | \$5380<br>(A\$5,260)   | \$1470<br>(A\$1,435)  | \$2940<br>(A\$2,870)  | \$190<br>(A\$184)  | \$190<br>(A\$184)     | \$190<br>(A\$184)     | 15                                  |
| Poland                   | \$2900<br>(PLN 10,000) | \$5800<br>(PLN 20,000)  | \$1450<br>(PLN 5,000) | \$2900<br>(PLN 10,000) | \$580<br>(PLN 2,000)  | \$1160<br>(PLN 4,000) | \$15<br>(PLN 50)   | \$30<br>(PLN 100)     | \$60<br>(PLN 200)     | 40                                  |
| Switzerland              | \$5730<br>(SFr 5,376)  | \$11550<br>(SFr 10,752) | \$4770<br>(SFr 4,480) | \$9540<br>(SFr 8,960)  | \$3820<br>(SFr 3,584) | \$7635<br>(SFr 7,168) | \$850<br>(SFr 800) | \$1700<br>(SFr 1,600) | \$3410<br>(SFr 3,200) | 4.5                                 |
| Ireland <sup>(3)</sup>   | \$1865                 | \$2330                  | \$1400                | \$1750                 | \$1025                | \$1285                | \$235              | \$235                 | \$235                 | 5.5                                 |

|  |          |          |          |          |        |        |        |        |        |  |
|--|----------|----------|----------|----------|--------|--------|--------|--------|--------|--|
|  | (€1,440) | (€1,800) | (€1,080) | (€1,350) | (€792) | (€990) | (€180) | (€180) | (€180) |  |
|--|----------|----------|----------|----------|--------|--------|--------|--------|--------|--|

**Russia, Mexico – free!**

- (1) Eband numbers are still proposed.
- (2) Links in a High Usage Path or in Congested Frequency Band Area
- (3) High density geographic location
- (\*) Note that many countries have the same price in E-Band to any bandwidth

**Other metrics to compare to India**

When coming to compare the spectrum cost with other countries, we can also look at two more metrics.

**The relative cost of the spectrum compared to the cost of the equipment**

Cost of a 100Mbps link in the UK is \$4,500 while in India it is \$2,800 (from the same vendor). This difference is coming from the highly competitive nature of the Indian Telecom market, and its high buying power. This means that even at same cost per link, the relative overhead of the spectrum fees on the equipment are higher than in the UK. If we also consider the fact that in the UK this payment is for any channel bandwidth used, that would imply that get to a common ground with the UK, **the annual cost of a 1GHz FDD license should be around 2,500 Rupees**

**The revenues generated by use of the spectrum**

Talking about high capacity links, we discuss mainly the data plans. The cost in the UK is around £10 per 1Gbyte, which is around 750 Rupees. The cost of 1Gbyte in India is around 600 Rupees in GSM and already 100 Rupees in CDMA. Since data tariffs in India are at infancy, we can expect an aggressive price erosion that will bring data tariffs in India to be much lower than in the UK, which again support our argument that **per link prices in India should be lower than UK since they generate lower revenues.**

**BIF PERSPECTIVE ON OTHER BANDS ( in 6-42 Ghz )**

BIF strongly supports the allocation of the frequency bands 10.15 – 10.65GHz, 24.5 – 26.5GHz and 27.5 – 29.5GHz to point-to-point (PTP) and to point-to-multipoint (PMP) applications. These bands

BROADBAND INDIA FORUM

The contents of this document are the exclusive privilege of the forum and shall not be replicated in any form without the exclusive approval of the forum

are globally harmonised by the ITU for this applications, and many global companies offer products conforming to the ITU-R specifications as follows.

| 10.5GHz          | 26GHz                  | 28GHz |
|------------------|------------------------|-------|
| Rec. F. 1568 [1] | Rec. 748-4 Annex 1 [2] |       |

BIF strongly supports the adoption of these ITU-R recommendations as the channel arrangements for these frequencies.

## Introduction to PTMP

### Considerations on Point-to-Multipoint (PTMP) for Regulatory Authorities

## Introduction

This document gives a high-level overview of modern microwave point-to-multipoint (PTMP) networks, describing some of the benefits of this technology for common applications such as mobile broadband backhaul. Yet PMP networks have several drawbacks that limit their use. These drawbacks compare to standard point-to-point (PTP) system are described as well.

Analysis of the 10.5, 26, 28 GHz bands availability and usage in other countries are summarized in this document as well.

The recommendation for the regulatory authority is to license the 10.5GHz, 26GHz and 28 GHz spectrum bands for the use of PTP networks (primary spectrum usage) and of PMP networks (secondary spectrum usage)

## 1 10GHz, 26 GHz and 28GHz spectrum use in other countries

ITU and ECC recommendations describe both PTP and PMP in these bands for valid deployments in these discussed bands. Analysis of the use of different countries in these bands shows that:

- Many countries have decided to banned PMP and allocate all the spectrum for PTP links only. This is due to the limit usage of PMP which will be described later in this document
- Some countries allocate part of the spectrum for PTP (larger portion of the band) and part of the spectrum for PMP (smaller portion of the band)

BROADBAND INDIA FORUM

The contents of this document are the exclusive privilege of the forum and shall not be replicated in any form without the exclusive approval of the forum

- No country found that allocates the entire bands for PMP networks on
- Other bands (different than 10, 26, 28 GHz are not opened for PMP networks at all

In addition to the regulatory bodies implementation, most of today mobile backhaul is done by PTP links rather than PMP.

## 1 Why use a point-to-multipoint architecture?

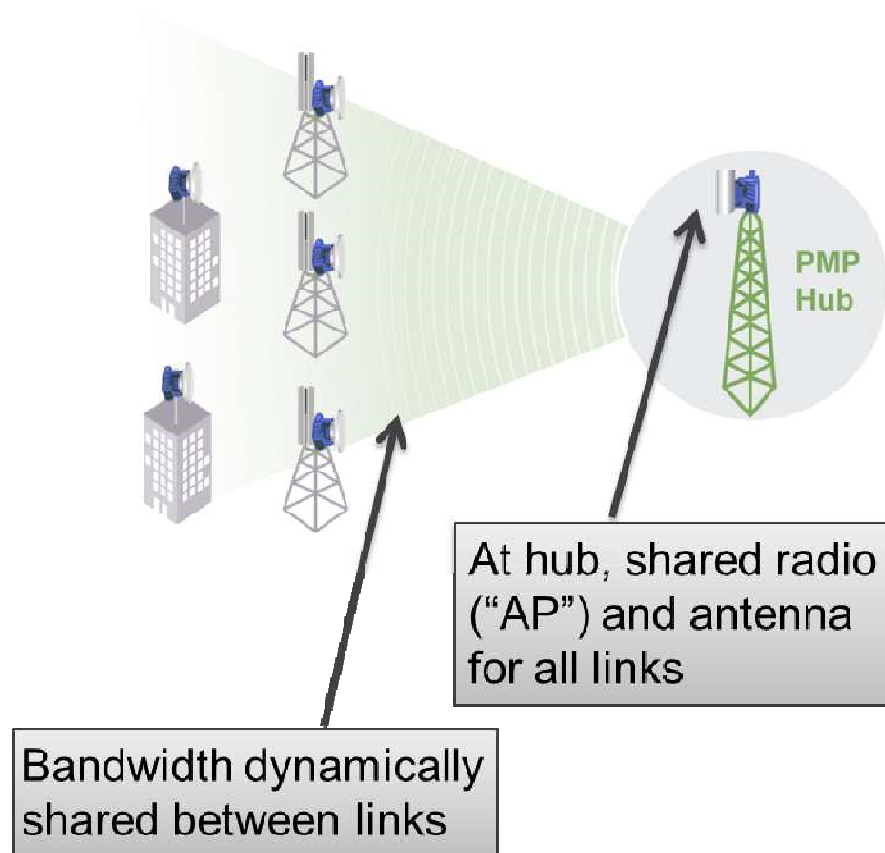

### **Figure 1: A point-to-multipoint (PTMP) sector serving five links**

The fundamental use case for a PTMP architecture is to create links between a hub site (on the right in figure 1) and a set of remote sites. Because the hub equipment and the radio frequency channel between the hub and the remotes are both shared, the cost of the hub equipment and spectrum is amortised over all the links in the sector. This applies to both capital and operating expenses.

The net result is that, when the average number of links in a sector is more than one, a PTMP design offers substantially lower per-link costs than alternative designs such as point-to-point (PTP). PTMP and PTP designs are complementary to one another and it is usually the case that both technologies will be used in different parts of a backhaul network. A comparison of the characteristics of the two technologies is shown in figure 2.

Because of this significant cost advantage, PMP has become the dominant network design paradigm for most types of wireless network. For instance, WiFi networks operate in a PTMP mode, as do GSM and UMTS (3G) mobile telephony networks. Within the telecom space, PTMP microwave technology as marketed by CBNL is used by 7 of the top 10 mobile operator groups (as measured by numbers of subscribers). PTMP in general is therefore a widely-understood and widely-adopted technology.

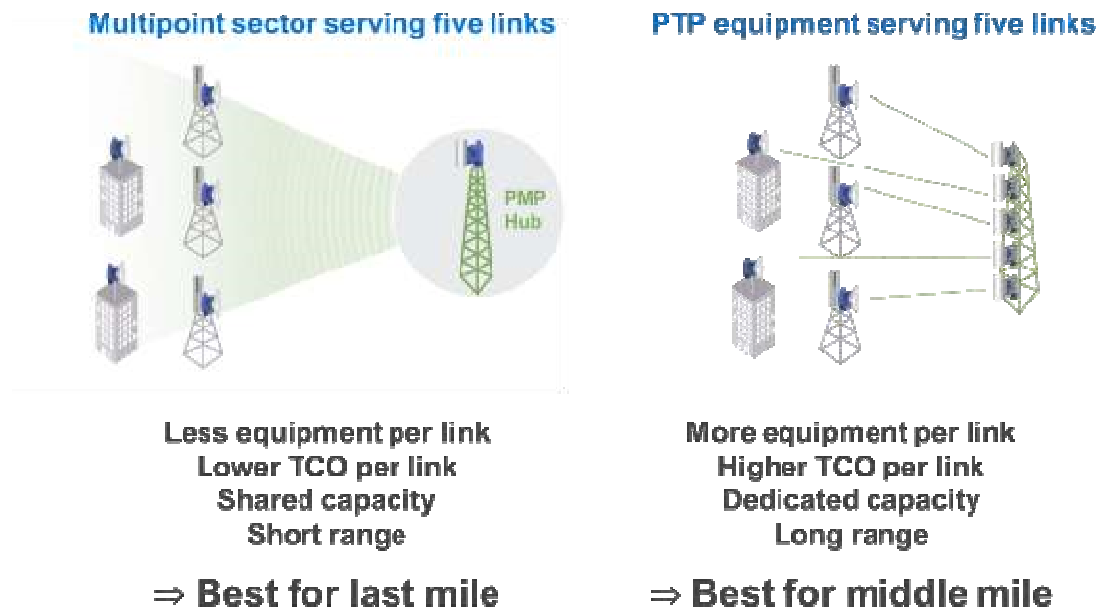

Figure 2: PTMP and PTP are complementary technologies

## **2 Choice of operational frequency**

As described above, the PTMP paradigm is applicable across a wide range of frequencies, and equally in licensed or unlicensed spectrum. For backhaul networks and enterprise access there are certain requirements that guide the choices.

### **2.1 Licensed or unlicensed?**

Because the backhaul network is critical to the operation of a mobile telephony network as a whole, typically operators will not use unlicensed spectrum for this application. The nature of unlicensed spectrum is that uncontrolled interference may arise without warning, and without any recourse. This consequently reduces the availability of the backhaul network if such interference is received. The type of service is often referred to as —best effort— and is generally not considered suitable for mobile backhaul other than in exceptional circumstances.



In contrast, licensed spectrum is preferred for backhaul, because the licensing process takes into account the possibility for interference and eliminates it through careful allocation of channels. Thus a true —carrier grade— service can be expected. This is therefore suitable for mobile backhaul, and is also preferred for enterprise access applications, where the higher grade of service will typically lead to reduced customer churn.

## 2.2 Low frequency or high frequency?

Low frequency RF has certain advantageous physical characteristics in terms of its propagation. Below approximately 6GHz, RF energy penetrates building materials and diffracts around obstructions. This makes these spectrum bands desirable for the operation of access networks such as 2G and 3G. However these characteristics are not generally required for backhaul. Therefore it is actually disadvantageous to use these bands for backhaul, in general, because the spectrum rented is economically in competition with access demands.

A particular factor is that, because of the desirability for access application described above, the spectrum below 6GHz is highly fragmented. It is therefore complex for regulators to aggregate large contiguous blocks of spectrum for lease to operators, and often would not be economic for the operator in any case. Finally, many of the currently-free bands in this part of the electromagnetic spectrum are proposed as extension bands for LTE, and there is therefore a question mark over the sustainability of use of these bands for the backhaul application.

In contrast, traditional microwave frequencies (approximately between 6GHz and 60GHz) are generally speaking plentiful, with large contiguous blocks available. Because these frequencies are not generally useful for mobile access there is less cross-application competition and these frequencies are likely to remain usable for backhaul for the foreseeable future.

## 2.3 The 10.5GHz, 26GHz and 28GHz bands

These three bands are globally harmonised by the ITU-R for point-to-multipoint usage according to the following recommendations:

| 10.5GHz          | 26GHz                  | 28GHz |
|------------------|------------------------|-------|
| Rec. F. 1568 [1] | Rec. 748-4 Annex 1 [2] |       |

Because of this harmonisation, there is a functional, competitive marketplace in the provision of equipment and services conforming to these standards (as of March 2014 there are at least 6 companies selling such equipment). There are, therefore, clear benefits for all parties in a territory in aligning to these international standards in terms of enjoyment of the economies of scale and a competitive marketplace.

For the regulator, specifying these regulations results in the spectrum being more likely to be used, which raises public revenue from a common good. For the operator, being able to use readily commercially available technology, with a choice of suppliers, results in competitive pricing. For vendors, being able to service multiple markets with a single product design is more

BROADBAND INDIA FORUM

The contents of this document are the exclusive privilege of the forum and shall not be replicated in any form without the exclusive approval of the forum

efficient. These benefits are also enjoyed at a remove by the network end-users and general public, through the ability of the operator to offer services at a lower price point. As previously highlighted, adoption of the technology is strong, with 7 out of the top 10 and XX out of the top YY mobile operator groups using the technology.

### **3 Efficient use of spectral resources**

The electromagnetic spectrum is a finite resource and it is therefore desirable for it to be used as efficiently as possible. Wasteful use of spectrum can lead to congestion, where insufficient resources are available to deal with increased demand, and (like traffic congestion on the road network), this kind of congestion is economically harmful to a country overall.

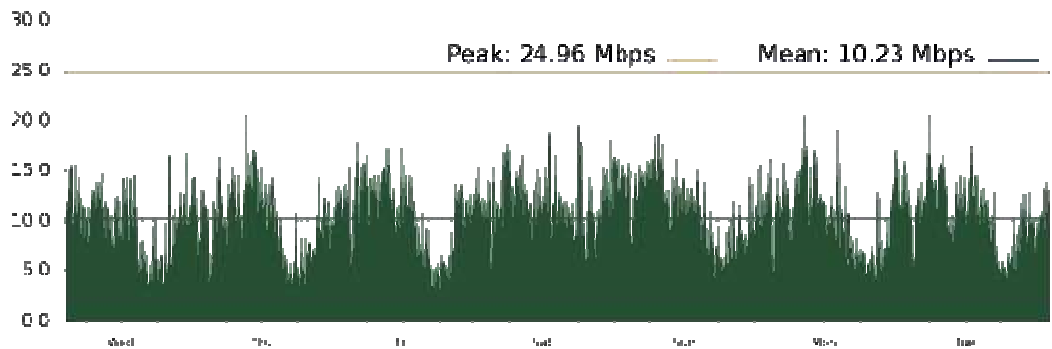

**Figure 3: Actual mobile broadband backhaul traffic with average peak and mean characteristics**

Mobile broadband backhaul traffic is not easy to transport efficiently because of its *bursty* nature, illustrated in figure 3. Rather than a smooth, continuous load of a certain number of megabits per second (Mbps), this type of traffic is characterised by an offered load that varies rapidly with time. One measure of the degree of burstiness of traffic is the *peak-to-mean ratio*. For perfectly smooth traffic of a uniform load, the peak-to-mean ratio is 1: the peak load and the mean load are identical. The larger the peak-to-mean ratio is when greater than 1, the burstier the traffic is. The traffic shown in figure 3 has a peak-to-mean ratio of  $= \frac{24.96}{10.23} = 2.44$ . This is approximately average for data-dominated mobile broadband traffic in 2014.

To understand why this type of traffic is hard to transport efficiently, let us consider dimensioning a wireless link to carry this traffic. If I assume that I do not wish to constrain the traffic because of the size of my link, I must provision as the capacity of the link *at least* the peak offered load— 24.96Mbps in this case. However, now consider what will be the utilisation of this link; this is defined as the mean load transported divided by the capacity. Since I only have one source of traffic, the mean load transported on the link must simply be equal to the mean offered load— 10.23Mbps in this case. My link utilisation, therefore, is the mean load— 10.23Mbps—divided by the capacity—24.96Mbps—or in other words the reciprocal of the peak-to-mean ratio; in this case  $\frac{10.23}{24.96} = \frac{1}{2.44} = 0.41 = 41\%$

We can see, therefore, that purely because of the traffic characteristics, and not because of any defect in the technology, a PTP wireless link carrying mobile broadband traffic will operate at a

low efficiency. The figures cited in the NGMN Alliance’s white paper *Guidelines for LTE Backhaul Traffic Estimation* [3] suggest a peak-to-mean ratio of as much as 5.6 for LTE serving cells.

For PMP, the efficiency of spectrum resource utilisation can be dramatically increased. This is possible because a multipoint system allows multiple access to the shared RF medium, and therefore there is more than one source of traffic load. To illustrate this, consider figure 4.

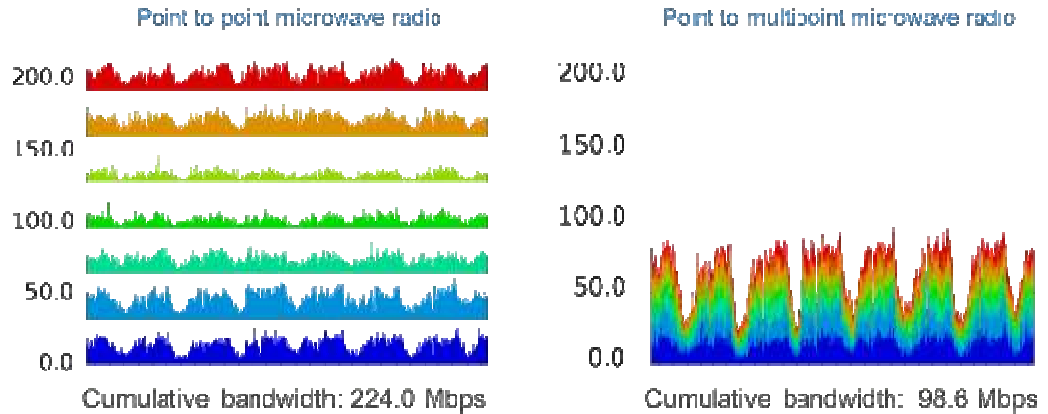

**Figure 4: Comparison of bandwidth needed to transport identical traffic using PTP and PTMP**

Here we illustrate, using actual data from a live DC-HSPA+ and LTE network, the dramatically improved efficiency possible with PTMP. On the left, we provision PTP links to carry each of seven node Bs’ backhaul traffic, requiring a total of 224Mbps. On the right, we carry exactly the same traffic in a PTMP sector. Statistically the peaks in bandwidth demand from different node Bs do not occur simultaneously, and therefore it is improbable that a peak in demand from one node B will coincide with a peak in demand from another. Therefore the peak of the aggregated traffic is much less than the sum of the peaks of the individual sources. We can calculate a theoretical figure for the increase in efficiency, known as the *statistical multiplexing gain*, by dividing the sum of the peaks of the individual sources by the peak of the aggregated traffic:

$$\text{statistical multiplexing gain} = \frac{\text{sum of peaks of un aggregated traffic } 177.1}{\text{peak of aggregated traffic } 98.6} = 1.8 \quad \text{for this example}$$

## BIF RESPONSE ON TRAI CONSULTATION PAPER FOR MICROWAVE ACCESS AND MICROWAVE BACKBONE CARRIERS

The statistical multiplexing gain is a measure of how much more efficiently the RF resources are used by the PTMP system. To illustrate that this is a universal phenomenon, and not a quirk of a chosen set of node Bs, the graph in figure 5 plots the statistical multiplexing gain for one operator's entire network of 3G and LTE base stations backhauled over PTMP. The abscissa of the graph is the number of 3G or 3G+LTE sites that are backhauled within a single PTMP sector. The network as a whole comprises almost 300 PMP sectors and approximately 1200 remote terminals, each co-located with a 3G or 3G+LTE site.

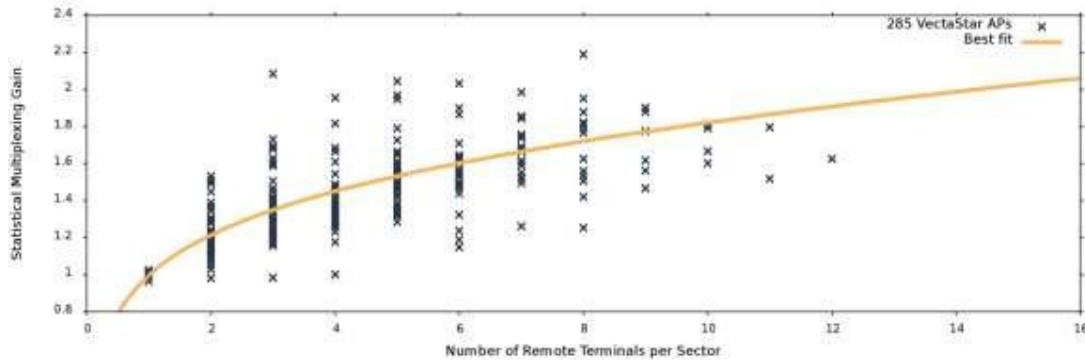

**Figure 5: Statistical multiplexing gain for an entire 3G and LTE network backhauled over PTMP**

It is possible to make a number of observations from this graph. First, as expected, if there is only a single remote terminal in the sector, there is unity statistical multiplexing gain; this degenerate case is equivalent to operating the PTMP sector as a PTP link. As the number of remote terminals increases, the statistical multiplexing gain increases monotonically. This is intuitive – the more sources of traffic are multiplexed together, the greater the probability that a peak in one source will cancel with a trough in another source.

The general trend in mobile networks is for an increasing geographic density of base stations or node Bs, because this increases the overall capacity of the network, and is one way to meet the increasing data demands of mobile users. Thus as time goes by, the average statistical multiplexing gain realised by PMP increases, as the trend is to move towards the right on the graph shown above.

## **4. Capacity and frequency re-use support in PTP & PMP**

PTP is a proven carrier grade technology while PMP technology suffers from several drawbacks that limit its penetration to the mobile backhaul market.

PMP networks consist of a hub and several remote terminals that connect to the hub. Since the hub communicates with several terminals its antenna is sectorial antenna which is wide-beam. In comparison PTP links has narrow beam directional antenna.

The antenna gain of sector antenna is quite low. Typical gain antenna is 16dBi at the main beam. In comparison typical PTP directional antenna of 1ft has antenna gain of 38dBi at least at the main

## BIF RESPONSE ON TRAI CONSULTATION PAPER FOR MICROWAVE ACCESS AND MICROWAVE BACKBONE CARRIERS

beam. The 22dB difference in hub's antenna reduces the overall link budget of the PMP link by this 22dB. Such significant lower link budget has several circumstances:

1. Having lower link budget reduces the maximum supported link distance. For example, the following use case was examined: 28MHz channel BW, 28 GHz frequency, India rain zone N, link availability of 99.995%, capacity of 220Mbps. The maximum link distance enabled by PTP is 900 meters for the described use case while in PMP the maximum link distance is limited to 400 meters
2. Different approach than point #1 is to translate the 22dB different link budget into different modulation scheme. The modulation scheme difference between PTP and PMP will be at least 6 modulation orders (each modulation order is ~3dB). This low modulation order supported by PMP has significant effect on link capacity and spectral efficiency. For example taking the same use case as before with a link distance of 900 meters, the capacity achieved in PTP is 220Mbps while only 90Mbps at PMP.

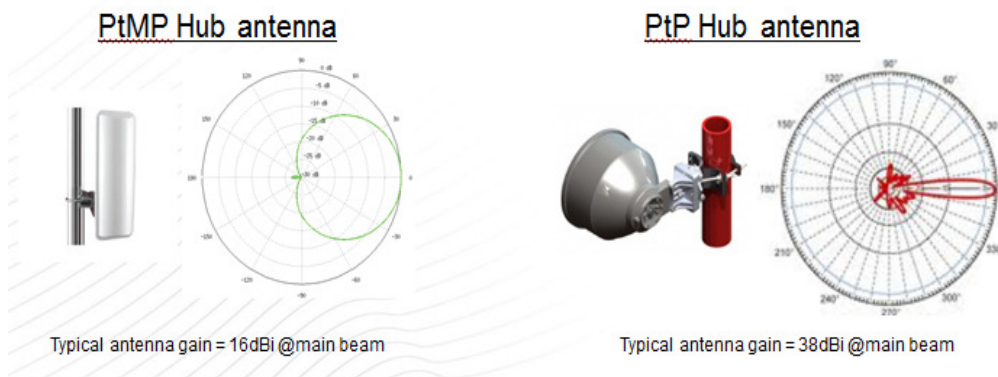

## **5. Frequency re-use and spectrum contamination comparison**

Another aspect of the PMP Hub's sector antenna is the poor ability of frequency re-use in the deployed network area and high spectrum contamination. In addition the Hub's of different PMP system strongly interfere to each other due to the wide-beam of their antenna in both the transmission and reception. Such mutual interference limit the system capacity beyond the phenomena already described in previous section (section #5) and limit the ability to re-use same frequency between different PMP systems.

Analysis of the different antenna pattern of PTP and PMP system show that PTP enable frequency re-use factor which is 3 times higher than PMP systems. This should be taken into account when considering the pricing of PTP allocation vs. PMP allocation.

## **6 Pricing for PTMP spectrum**

While it is possible for a regulator to license PTMP on a link-by-link basis exactly analogously to PTP licensing, it is more common to license PTMP spectrum on an area basis. A common model,

## BIF RESPONSE ON TRAI CONSULTATION PAPER FOR MICROWAVE ACCESS AND MICROWAVE BACKBONE CARRIERS

explored in ITU-R recommendation ITU-R SM.2012-3 [4], is to charge a fee based on the amount of bandwidth used, the operating frequency and the area serviced:

$$\text{fee} = \text{baseline cost} \times \text{bandwidth in Mz} \times F \times A$$

Here,  $F$  is a factor that varies with the operational frequency and  $A$  is a factor that varies with the area serviced. Example values for  $F$  and  $A$  given in the following tables.

| Lower limit | Upper limit | $F$  | Lower limit             | Upper limit             | $A$ |
|-------------|-------------|------|-------------------------|-------------------------|-----|
| 30 MHz      | 174 MHz     | 1.00 | -                       | 1 km <sup>2</sup>       | 0.6 |
| 174 MHz     | 880 MHz     | 0.75 | 1 km <sup>2</sup>       | 10 km <sup>2</sup>      | 2   |
| 880 MHz     | 1.8 GHz     | 0.50 | 10 km <sup>2</sup>      | 100 km <sup>2</sup>     | 6   |
| 1.8 GHz     | 5.0 GHz     | 0.40 | 100 km <sup>2</sup>     | 1,000 km <sup>2</sup>   | 18  |
| 5.0 GHz     | 10.0 GHz    | 0.30 | 1,000 km <sup>2</sup>   | 10,000 km <sup>2</sup>  | 56  |
| 10.0 GHz    | 17.0 GHz    | 0.20 | 10,000 km <sup>2</sup>  | 100,000 km <sup>2</sup> | 180 |
| 17.0 GHz    | 23.0 GHz    | 0.15 | 100,000 km <sup>2</sup> | 500,000 km <sup>2</sup> | 400 |
| 23.0 GHz    | 30.0 GHz    | 0.10 | 500,000 km <sup>2</sup> | -                       | 600 |
| 30.0 GHz    | -           | 0.05 |                         |                         |     |

CB-003424-TN-2

## Conclusion for PTP and PTMP

PTP networks has higher capacity, support higher link distance, better spectrum re-use factor and lower interference. All of these make the PTP the Operator's major choice for mobile backhaul deployments.

We recommend to open the 10.5GHz, 26GHz and 28 GHz for use in India while allocate the spectrum primarily to PTP and secondary to PMP. In addition a contamination factor should be taken into account. The higher contamination factor of PMP networks should make the PMP frequency channel license fee higher than PTP frequency channel license.

Submitted by:

Anil Prakash

Secretary General

BROADBAND INDIA FORUM

Suite 304, Gagan Deep

12, Rajendra Place

New Delhi- 110008, India

Mobile +91-98111 55846,

Tel: +91-11-2575 7128

Fax: +91-11-25757129

Skype ID:anil.prakash

email. [anilprakash@yahoo.com](mailto:anilprakash@yahoo.com) , [anilprakash@gmail.com](mailto:anilprakash@gmail.com)

# White Paper on Millimeter Wave Technologies

## 1. Executive Summary

The motivation to use E-band in India seems stronger than in the rest of the world due to the special conditions of the Indian Telecom market, that include: very high density in the urban areas, urgent need to increase the capacity of data services (mobile broadband), the general shortage of microwave spectrum for backhaul and the need to allocate such spectrum to new operators and rural deployments.

The unique characteristics of the Eband spectrum: The short range (up to 1Km, in the high intensity rain zones of India while in most of the western world it is up to 2.5Km), the high spectral reuse in dense urban areas, and the ability to achieve small form factor, coupled with low cost equipment make it ideal for last mile urban deployments, subject to the existence of an appealing business case to encourage usage of new equipment in this band.

The aggressive price reduction of microwave equipment, mainly driven by the large Indian Telecom market, has made the charges for the wireless spectrum/ licenses as a major burden. Most of the countries that have opened the E-band spectrum, have done so with a pricing policy in which the cost per MHz is 200 to 400 times less than in the 8-38GHz band!

The major financial benefit to the government from encouraging the use of E-band lies in the large potential of increasing the overall operator revenues, and hence the revenue share on account of license fee, spectrum charges (from other spectrum allotments) and other levies that are derived from them, and not from direct revenue from this unused/ virgin spectrum, which presently is bringing no revenue.

What is expected?

An E-Band Spectrum Policy that will encourage the use of this technology by opening it up at a minimal charge (if not completely free!) with a technology neutrality specification that will enable a multi-vendor market that will drive high competition, low prices, and high deployment rates that will accelerate the mobile broadband usage in India.

- **Per link policy where each 2 X 250MHz channel (“spot”) will be around 1,500 Rupees annually.**
- **During 5 year transition period:**
  - **First 2 years during which frequency will be charged at 80% discount.**
  - **Further 3 years during which the operators will receive 50% discount.**

## 2. E-Band Spectrum

Mobile operators worldwide are turning to the E-band spectrum specifically the 71-76 GHz, 81-86 GHz bands to enhance and streamline their backhaul networks. Due to the large allocated spectrum and propagation characteristics at these frequencies, wireless backhaul systems operating at these frequencies, also referred to as millimeter-wave wireless systems, can provide up to multi-gigabit capacities for relatively short distances of a few kilometers. The antennas used in E-band frequencies are highly directional and together with the propagation limitations, wireless systems operating at the E-band frequencies are highly focused, point-to-point “pencil beam” links allowing a much higher reuse of the same frequency in a given area.

Utilizing the E-band spectrum, mobile operators can better design their backhaul, allowing a more efficient frequency plan. Mobile operators are building a layered backhaul network where the 6-38 GHz spectrum will be used for relatively long-haul transmission and the E-band spectrum for high-capacity, short-haul links particularly in urban and sub urban deployments. Doing so, mobile operators are able to increase their backhaul capacity according to their increasing needs without causing frequency congestion. This allows the mobile operators to introduce new and advanced mobile broadband services to the consumers. The consumers on the other hand are enjoying the true experience of mobile broadband at their fingertips.

The mm-wave (E-Band) band, with two 5GHz blocks of spectrum allocated at 71-76GHz and 81-86GHz, benefits from the large channel bandwidth available in this frequency, with typical channel bandwidth of 250MHz, and channel aggregation that is allowed up to the entire 5GHz of available spectrum. As the operating frequency increases, the propagation of a radio wave transmitted from a given antenna becomes more directional. In a dense environment where many links are expected to operate in close proximity, this translates to better spatial isolation between links, and practically zero interference. Recognizing the minimal risk of interference when operating in this band, regulators worldwide adopted a new, 'light licensing' paradigm. Under this 'light licensing' paradigm link licensing is based on quick (mostly online) registration, extremely low spectrum license fees, and technology neutrality to duplexing (TDD/FDD), channel aggregation and modulation beam. The main limitation imposed on this band is the requirement for a minimum antenna gain (38/43dBi in EU/US) in order to maintain a directivity level that will ensure the spatial diversity.

The high sensitivity of this band to rain attenuation, limits the practical ranges of equipment operating in this technology to 2 – 2.5 Km (and even less than 1 Km in monsoon areas), making it ideal for high density broadband deployments. Channel aggregation and advanced modulation techniques can scale this technology to 5Gbps and more, while maintaining small form factor and low power consumption.

Commercial equipment working in this band has been available in the last decade, providing GigE wireless links, mainly for enterprise and vertical applications.



### 3. The Motivation for E-band in India

Allocating the E-band spectrum for use in India will generate additional revenues to the Government of India:

- **Revenues from new mobile broadband data services:** Allocating and utilizing the E-band spectrum will enable mobile operators to offer and provide to their customers a wide variety of mobile broadband services, especially in dense urban areas. These services will generate new and significant additional revenues to the mobile operators which in turn will pay the Government of India a percentage of these revenues as agreed in the terms of the license fee and other levies, including enhanced charges for access and other microwave spectrum. The table below shows the numbers (rupees in crores) for the first quarter of 2013. It is evident that any increase in revenues contributes more than 10% (close to 15% in the Metro and A circles) in license fees.

|                       | GR -<br>Gross Revenue | AGR -<br>Adjusted GR | License Fees |             | Spectrum Charges |             |
|-----------------------|-----------------------|----------------------|--------------|-------------|------------------|-------------|
| Circle type           |                       |                      |              |             |                  |             |
| Metro                 | 5,900                 | 3,682                | 371          | 10.1%       | 181              | 4.9%        |
| A                     | 11,489                | 8,391                | 839          | 10.0%       | 445              | 5.3%        |
| B                     | 10,614                | 7,734                | 621          | 8.0%        | 366              | 4.7%        |
| C                     | 3,672                 | 2,728                | 164          | 6.0%        | 126              | 4.6%        |
| <b>Total (crores)</b> | <b>31,674</b>         | <b>22,535</b>        | <b>1,994</b> | <b>8.8%</b> | <b>1,118</b>     | <b>5.0%</b> |
| <b>(\$M value)</b>    | <b>6,694</b>          | <b>4,762</b>         | <b>421</b>   |             | <b>236</b>       |             |

Charges in Crores of rupees for the Quarter ended in March 2013

- **Revenues from an unused spectrum:** Allocating the E-band would lead to the utilization of a band which is presently unused / virgin and thus brings “zero” revenues to the Government of India. Its utilization would bring reasonable revenues for its usage (even at nominal spectrum charges).

Allocating the E-band spectrum in India will facilitate data hungry mobile broadband services while contributing to release some spectrum in conventional lower microwave bands, which in turn would enable additional advanced telecommunications and data services to rural areas in India as well.

- **Enabling mobile broadband data services:** With the dramatically increased capacity requirements by modern data services and increase of the density of the cell-sites deployed in 3G and 4G networks mobile operators are turning to the 71-76 / 81-86 GHz E-band spectrum to increase their backhaul capacity while introducing new and advanced mobile broadband services to the consumers. With the astonishing large numbers of mobile subscribers that are added each month, it is important that mobile operators will have the entire necessary spectrum to plan their backhaul network to provide adequate solutions to the near and long term challenges. As we can see below, the number of broadband

subscribers is still very low, and is expected to dramatically increase and surge network backhaul capacity requirements because of subscriber numbers and various new applications.

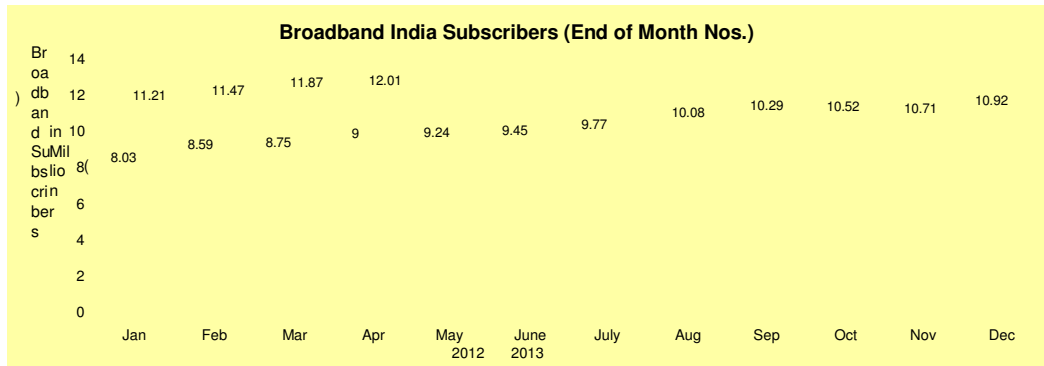

- **Improving the strength to the Telecom Operators:** In an era of falling ARPU's, data and VAS are the main source of increasing operator revenues. This kind of services is, and will be highly dependent on adequate capacity of networks, including backhaul capacity.
- **Coping with the spectrum congestion:** The increasing number of wireless backhaul links together with the scarcity of available spectrum is eventually leading to a congestion of the microwave spectrum even to a point where it will no longer be available for new operators, new links or allocations. Due to the large allocated spectrum and propagation characteristics of the 71-76 / 81-86 GHz E-band, wireless backhaul systems operating at these frequencies can provide up to multi-gigabit capacities for relatively short distances of a few kilometers with a much higher reuse of the same frequency in a given area.
- **Contribution for telecommunication and data services in rural India:** New mobile operators which are making an effort to bring broadband services to the rural areas in India have limited 15-18 GHz spots as these are taken by the established operators. Designing and implementing a backhaul network which uses the E-band spectrum will allow a more efficient distribution of the 15-18 GHz spots amongst the established and new operators which is vital for rural deployments.

## 4. Pricing

Since E-Band links are going to be implemented in urban short overlays over the existing microwave structure, initial deployments will contribute only to part of the operator revenues, therefore royalty based pricing cannot be practically implemented, as it will result with a too high cost per link when one calculates the circle AGR versus the number of links to be deployed. **The bottom line is that E-Band links cannot be priced on royalty basis, even at very low percentage.**

The current per-link pricing scheme enforced in India is calculated according to the following formula such that a 28 MHz channel, short range (up to 5 km) link would cost 288,000 Rupees (~US\$ 5,760):  $R = M \times W \times C$

Where:

- **M** – Constant multiplier depending on the distance of the link. The shorter the link the small M is (for

example: M=1200 for links up to 5 Km and M=2400 for links up to 25 Km). **We suggest M value of 600 for links of up to 2Km.**

- **W** – Weighting factor decided by the adjacent channel separation of the channeling plan (for example: W=30 for adjacent channel separation above 2 MHz and W=120 for adjacent channel separation greater than 7 MHz but less than or equal to 28 MHz (since from 2MHz to 28MHz W was increased by a factor of 4, a similar proportionate factor when going from 28MHz to 250MHz would be 2.55). **We suggest W=360 for a 250MHz Channel**
- **C** – Number of RF channels used. **C= 2 for 500MHz TDD or 250MHz FDD systems and 8 for 1000MHz FDD systems**
- **E** – We propose a new correction factor, based on the re-use and spectral efficiency (as detailed in Annex 8a - Method 1) and **suggest setting it at 1/300.**

Taking these factors together the per-link pricing scheme suggested for the E-band spectrum is as follows:

- **500MHz TDD:  $R = M \times W \times C \times E = 600 \times 360 \times 2 / 300 = 1,440$  (say 1,500) Rupees (~US\$30)**
- **1000MHz FDD:  $R = M \times W \times C \times E = 600 \times 360 \times 8 / 300 = 5,760$  (say 6,000) Rupees (~US\$120)**

If we perform a “sanity check” according to method 2 in the previous section, we conclude that the same 2\*250MHz channel should cost 1,350 Rupees which is along the same numbers as suggested here.

## 5. Trials in India and Abroad

- Poland
  - Mobile Operator A (Nov 2010 – Feb 2011) – Lab trial (2 weeks), Outdoor trial (3 month) with real traffic
- Russia
  - Mobile Operator A (March 2011) – Lab trial (2 weeks), received test report signed by operator as successful
  - Mobile Operator A (June 2011 – on going) – outdoor installation carrying live IPTV traffic
  - Mobile Operator B (August 2011) - Lab trial (2 weeks) with regional affiliate, received test report signed by operator as successful
  - Mobile Operator C (December 2011) – Lab trial, received test report signed by operator as successful
- Romania
  - Mobile Operator A (June 2011 – August 2011) – Local affiliate of tier 1 global operator. Lab trial, followed by 3 month availability outdoor trial during the 3 most rainy months of the year. Results matched expectations
- India
  - Mobile Operator A (August 2011 – November 2011) – outdoor trial of 3 links during the last 6

weeks of the monsoon season, followed by 2 “dry” months. Results matched expectations

## 6. What do we want

India has the potential to be the biggest user of E-Band technology while it is shaping up. This will both drive the mobile broadband infrastructure in India, and also create an opportunity to the Indian market to influence this industry. In order for that to happen we need to have the following:

- Spectrum Allocation for broadband use
- Technology Neutrality specifications that will enable the competition of many vendor in the Indian market
- Minimal charge (if not completely free!) of this band.
- Quick and friendly way to register and install the equipment in this frequency

## 7. Annexes

### a. Pricing Models and Methodologies

#### **Method 1 – Carrier Value Perspective [bits/Hz/area]**

Basically we pay for the number of bits we provide in a certain area (modeled by distance and angle). The following factors should then affect the licensing fees / spectrum charges of the E-band spectrum:

- **Typical spectral efficiency:** In the E-band spectrum there are two bands of 4.75 GHz of continuous spectrum in each of the 71-76 GHz and 81-86 GHz frequency bands which are divided into large 250 MHz channels which can even be aggregated. The available spectrum together with the large channels allows achieving high data rates while using low modulation states as limited by the high frequency. As such, typical E-band wireless systems that are available in the market today have a spectral efficiency of upto 2 bits/sec/Hz. In comparison, traditional microwave bands where typical channel size is 28 MHz, high data rates are achieved by using high modulation techniques and XPIC antenna technologies. As such, wireless microwave has a spectral efficiency of 7 bits/sec/Hz (2X7 bits/sec/Hz including the XPIC).
- **Typical Link Distance:** The propagation characteristics and rain fading of the E-band spectrum result in an effective, link range of about 1 Km. For comparison, the typical link distances of lower frequencies (15 GHz or 18 GHz) are 10 to 15 Km on average as the free-space-loss and rain attenuation are less significant in these frequencies.
- **Re-Use Factor:** The highly directional, “pencil beam” propagation characteristics of E-band wireless systems mean that operators can plan and deploy networks with an extremely high degree of frequency reuse, minimal frequency coordination and deploy links very close to one another with minimal interference concerns. Due to antenna transmission patterns (beam width 2-5 times lower) we can assume a re-use factor that is around 3 times higher in E-band compared to traditional microwave bands (this is without taking propagation into account since it is factored into the link distance).

The above mentioned factors are summarized in the table below:

| Band      | Frequency [GHz] | "contamination" Factor <sup>1</sup> [MHz] | Spectral Efficiency [Bits/second/Hertz] | Link Distance [Km] |
|-----------|-----------------|---|---|--------------------|
| Microwave | 15, 18, 23      | 3   | 7 x 2 (XPIC)                            | 15                 |
| E-band    | 71-76, 81-86    | 1   | 2                                       | 1                  |

(1) "Contamination" factor is the reciprocal of the Re-use factor

$$\text{Cost Multiplier} = \frac{3 \times 7 \times 2 \times 15 \text{ (15, 18 GHz)}}{1 \times 2 \times 1 \text{ (E - band)}} = \frac{630}{2} = 315$$

Taking into account channel sizes we get to the conclusion that **a 2 X 250 MHz E-band channel should be 33 times lower than a 2 X 28MHz microwave channel**, which is very much in line with the 20-40 range we find in other countries.

### **Method 2 – Fees as per Area covered/ affected by link**

Another way to consider the license fee per link, is to see what is the typical area one link (and therefore one annual fee) can cover, and then estimate how many E-Band links can coexist in the area covered by a link in conventional microwave bands, and therefore generate multiple license fees.

**Number of E-Band links in one microwave area (in conventional bands)**

| Fmin     | Fmax                       | Fave | Θ   | R  | S            | Per link price                                     |
|----------|----------------------------|------|-----|----|--------------|--|
| 71       | 76                         | 73.5 | 1   | 2  | 0.0349 Sq-Km | 288000 WPC formula for 28MHz Channel               |
| 15       | 23                         | 19   | 3.9 | 15 | 7.5956 Sq-Km | 1324 Target 250MHz Channel according to area ratio |
| Θ        | Antenna 3 db angle         |      |     |    | 217.60 ratio |  |
| R        | Link effective range       |      |     |    |              |  |
| S (area) | $\pi * R^2 * \Theta / 360$ |      |     |    |              |  |

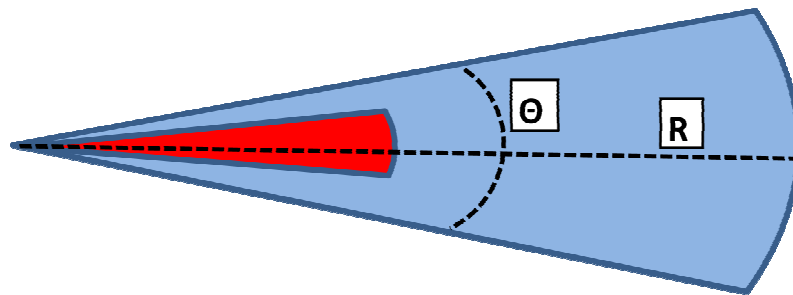

According to the calculation above, the per-link annual cost of an E-Band link (2\*250MHz) should be around 1,350 Rupees

## b. Annual Frequency Costs in foreign countries

| Frequency (GHz)          | 15                     |                         | 23                    |                        | 38                    |                       | 71-76/81-86        |                       |                       | 38<br>(56MHz) t             |
|--------------------------|------------------------|-------------------------|-----------------------|------------------------|-----------------------|-----------------------|--------------------|-----------------------|-----------------------|-----------------------------|
| Bandwidth (MHz)          | 28                     | 56                      | 28                    | 56                     | 28                    | 56                    | 250                | 500                   | 1000                  | E-band<br>(500MHz)<br>ratio |
| India <sup>(1)</sup>     | \$6,300                |                         | \$6,300               |                        |                       |                       | \$30               | \$60                  | \$120                 | 215                         |
| USA                      | \$230                  | \$230                   | \$230                 | \$230                  | \$230                 | \$230                 | \$7.5              | \$7.5                 | \$7.5                 | 30                          |
| UK                       | \$1650<br>(£1,060)     | \$3290<br>(£2,120)      | \$1150<br>(£740)      | \$2300<br>(£1480)      | \$1000<br>(£640)      | \$2000<br>(£1,280)    | \$80<br>(£50)      | \$80<br>(£50)         | \$80<br>(£50)         | 25                          |
| Australia <sup>(2)</sup> | \$2690<br>(A\$2,630)   | \$5380<br>(A\$5,260)    | \$2690<br>(A\$2,630)  | \$5380<br>(A\$5,260)   | \$1470<br>(A\$1,435)  | \$2940<br>(A\$2,870)  | \$190<br>(A\$184)  | \$190<br>(A\$184)     | \$190<br>(A\$184)     | 15                          |
| Poland                   | \$2900<br>(PLN 10,000) | \$5800<br>(PLN 20,000)  | \$1450<br>(PLN 5,000) | \$2900<br>(PLN 10,000) | \$580<br>(PLN 2,000)  | \$1160<br>(PLN 4,000) | \$15<br>(PLN 50)   | \$30<br>(PLN 100)     | \$60<br>(PLN 200)     | 40                          |
| Switzerland              | \$5730<br>(SFr 5,376)  | \$11550<br>(SFr 10,752) | \$4770<br>(SFr 4,480) | \$9540<br>(SFr 8,960)  | \$3820<br>(SFr 3,584) | \$7635<br>(SFr 7,168) | \$850<br>(SFr 800) | \$1700<br>(SFr 1,600) | \$3410<br>(SFr 3,200) | 4.5                         |
| Ireland <sup>(3)</sup>   | \$1865<br>(€1,440)     | \$2330<br>(€1,800)      | \$1400<br>(€1,080)    | \$1750<br>(€1,350)     | \$1025<br>(€792)      | \$1285<br>(€990)      | \$235<br>(€180)    | \$235<br>(€180)       | \$235<br>(€180)       | 5.5                         |

(1) Eband numbers are still proposed.

(2) Links in a High Usage Path or in Congested Frequency Band Area

(3) High density geographic location

(\*) Note that many countries have the same price in E-Band to any bandwidth

### c. Other metrics to compare to India

When coming to compare the spectrum cost with other countries, we can also look at two more metrics

- **The relative cost of the spectrum compared to the cost of the equipment**  
Cost of a 100Mbps link in the UK is \$4,500 while in India it is \$2,800 (from the same vendor). This difference is coming from the highly competitive nature of the Indian Telecom market, and its high buying power. This means that even at same cost per link, the relative overhead of the spectrum fees on the equipment are higher than in the UK. If we also consider the fact that in the UK this payment is for any channel bandwidth used, that would imply that get to a common ground with the UK, **the annual cost of a 1GHz FDD license should be around 2,500 Rupees**
- **The revenues generated by use of the spectrum**  
Talking about high capacity links, we discuss mainly the data plans. The cost in the UK is around £10 per 1Gbyte, which is around 750 Rupees. The cost of 1Gbyte in India is around 600 Rupees in GSM and already 100 Rupees in CDMA. Since data tariffs in India are at infancy, we can expect an aggressive price erosion that will bring data tariffs in India to be much lower than in the UK, which again support our argument that **per link prices in India should be lower than UK since they generate lower revenues.**

## 9. Interference Analysis

### 9.1 Guard Bands and Channel Planning

In this section, we will discuss potential interference to and from adjacent bands and propose a solution to minimize the risk of interference to and from fixed point-to-point and other services in the millimeter band.

As will be shown in the following sections, the potential interference risk from the spurious and out-of-band emissions from vehicular radar operating in the 76-77 GHz band has been discussed. Out-of-band emissions are implicitly restricted by defining transmitter “99% power” emission bandwidth [27]. Namely, the occupied bandwidth is defined as the band which leaves 0.5% of the signal power above and 0.5% of the signal power below the bandwidth limits. In such a way,

the band contains 99% of the signal power.



By applying the transmitter “99% power” emission bandwidth and taking into account that the maximum permissible EIRP emitted by the vehicle radar within the 76-77 GHz band is 25 W, the emissions in the 125 MHz adjacent bands may achieve significant levels.

Secondly the adjacent 86-92 GHz band is allocated to the Radio Astronomy, Earth-Exploration Satellite and Space Research Services. It has been proposed in several ITU papers to protect the radio astronomy service through the application of notification zones. While the Earth-Exploration Satellite and Space Research Services are allocated in the NFAP, there are as yet no other regulatory arrangements or channel plans or assignments in the band. Nevertheless, all emissions are prohibited by footnotes 5.149 and 5.561.

Additionally, the 77-81 GHz band (the ‘79 GHz range band’) has been designated for use by automotive short range radars in ECC decision [28]. Although, the equipment shall be designed to operate with a maximum mean power density of -3 dBm/MHz (and peak power of 55 dBm EIRP) and vehicles shall be equipped with 79 GHz automotive radar from 2013, adequate planning of services in the adjacent bands may improve the level of radio spectrum efficiency.

Therefore, the minimum interference environment for the operation of the fixed point-to-point 70/80 GHz links might be achieved by introducing **a 125 MHz guard band at the top and bottom of each 5 GHz band**. The positions of the guard bands should be in line with the CEPT [15] and Ofcom arrangements [19].

Finally, a channel plan should not be defined in the 71.125-75.875 GHz and 81.125-85.875 GHz bands. It is proposed that by not insisting on using a specific channel plan, equipment with a variety of modulation schemes may be utilized encouraging further technological development.

### **Channeling Plan**

Some countries like the US and Australia have selected not to allocate channels, assuming that since this frequency band has high frequency re-use, area based licensing will enable flexible usage of the spectrum. Other countries (mainly Europe) have selected the ETSI/CEPT 250MHz channel plan, although they allow unlimited aggregation of any number of channels, and also charge a flat rate for the use of the E-Band on a per link basis, but with the price not being dependent on the number of channels taken by the user.

When deciding on the channeling arrangement, a few considerations have to be taken into account:

- The bandwidth to be used by the equipment (currently most of the vendors support 1000MHz, a few support 500MHz and 250MHz, with more vendors announcing the support of 250 and 500MHz)
- The equipment duplexing method TDD and FDD.
- The coordination function the regulator would like to use.

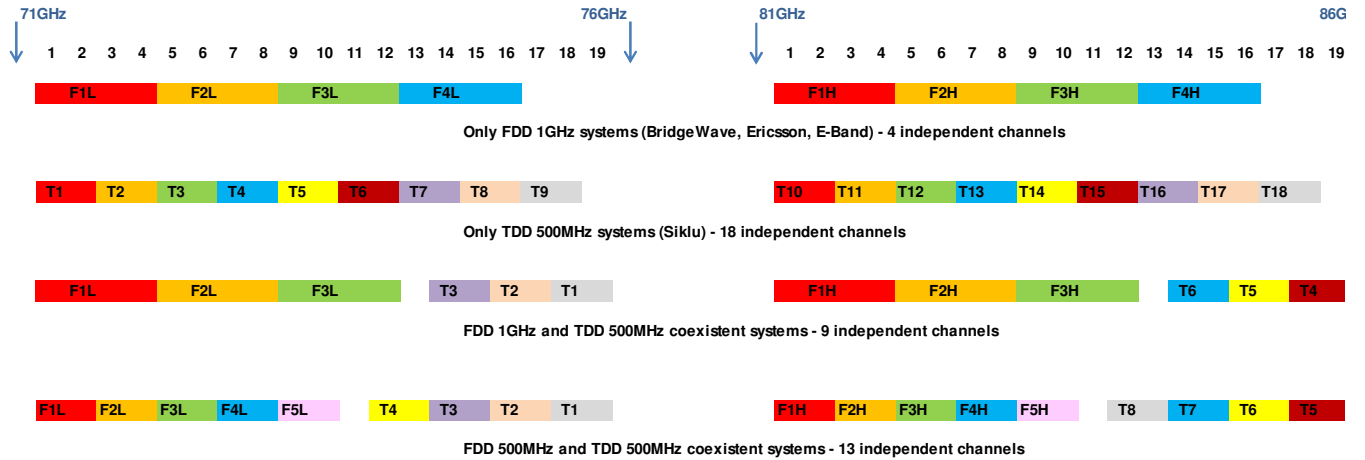

Figure 1: Possible Channel Arrangements to support various bandwidth and duplexing equipment

One thing that is clearly obvious from figure 15 is that there are not enough channels to allocate channels per operator. It will also be most in efficient since it will “spread” the spectrum and not allow all the potential users to enjoy the spatial re-use qualities of this spectrum.

## 9.2 Inter Link analysis (Far End)[23]

The focus in this section is on unchannelized coordination with the worst-case assumptions, i.e. co-channel interference coordination, between systems that are not collocated in the same site (far end).

The primary source of interference for narrow-beam 70/80 GHz links is line-of-sight power directed into the main lobe or a side lobe of a victim receive antenna. Other effects such as multipath and atmospheric stratification are not significant for operation in this band due to the extremely narrow beams in which the radiation propagates.

In [23], the interference analysis is based on threshold-to-interference (T/I) ratio. It is recommended that successful path coordination should guarantee that interference could never cause carrier-to-interference (C/I) level to be less than the manufacturer recommended T/I level (Figure 15), except in special cases (such as very short link path lengths) where the service availability of the affected receiver will always remain acceptable despite the interference.

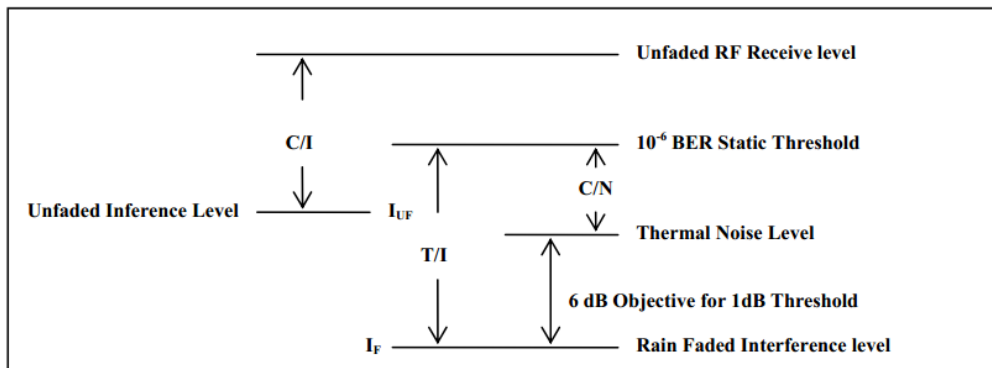

Figure 2: Signal level diagram relating receiver carrier, threshold, and noise floor levels with faded and non-faded interference objectives levels [23]

The advantages of using T/I-based criteria are that the difference in thresholds, due to bit rate, modulation technique (transmission efficiency), coding gain and noise figure, are all taken into account, and that the absolute level of allowable interference can be easily determined by subtracting the T/I ratio from the static threshold (defined for bit-error-rate equal to  $10^{-6}$ ) of particular digital receiver.

### Adaptive Transmit Power Control and Adaptive Rate

Heavy rain limits the opportunity for full implementation of point-to-point systems in terms of installation distances and frequency usage (Section 5.2). One possible solution to overcome the rain attenuation problem is the use of an Adaptive Transmit Power Control (ATPC) system incorporated in the front-end of the radio-unit. Another solution would be to use the link budget gain of the Adaptive Rate system (also referred to as Adaptive Coding and Modulation [ACM] or Adaptive Bandwidth Coding and Modulation [ABCM]). A discussion to compare the two methods is

provided later.

### Analysis steps to determine interference for several possible scenarios

In order to determine possible interference in the proximity of the observed receiver, the following steps are recommended by Wireless Communication Association in [23]:

1. All links placed within the radius of Km around the midpoint of a proposed link should be included for possible interference assessment.
2. The clear-air interference calculations are based on the worst-case from each registered transmitter in the area into each proposed receiver. The worst-case assumption is the case when the desired signal is fully rain-faded and the interferer signal has no rain fading.
3. For some link geometries, paths may be near enough in azimuth that they are affected by the same rain cell and thus have correlated rain fading (Data on the spatial correlation of the rain event is scant. However, a rudimentary model can be based on the work in [24]).

The range of azimuth can be calculated as (Figure 15):

$$\theta = 2 \arctan\left(\frac{r}{d}\right) \quad (3)$$

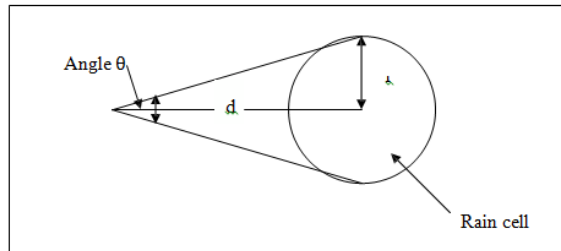

Figure 3: Included angle to assume rain fading

A rain event consists of small “volume cells” of intense rain rate within much larger “debris regions” with a lower rain rate. The dimensions of these areas are inversely related to rain rate (Figure 11). In the debris region, rain rate tends to be approximately log-normally distributed with a low median. Figure 17 shows the rain attenuations as a function of the rain rate. Thus a conservative model for interference assumes that when the worst- case rain fade of the desired signal occurs, any interfering signal travels only through the debris region

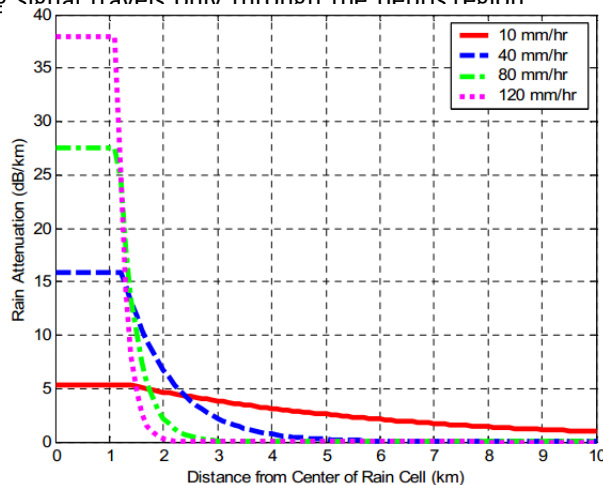

Figure 4: Rain rate attenuation versus distance from center of a typical rain cell

The following examples are given to facilitate determination of the possible worst-case scenario under different weather conditions. The criterion (4) has to be satisfied in the following cases:

$$\frac{C/I}{\text{Actual}} \geq \frac{T/I}{\text{Required}} \quad (4)$$

1. The victim link carrier level to reach the static threshold
2. The victim link ATPC (Adaptive Transmit Power Control) to begin to increase the transmitter power
3. The interfering link ATPC to reach maximum power

**Example 1: Approximately Collinear Desired and Interfering Propagation Paths**

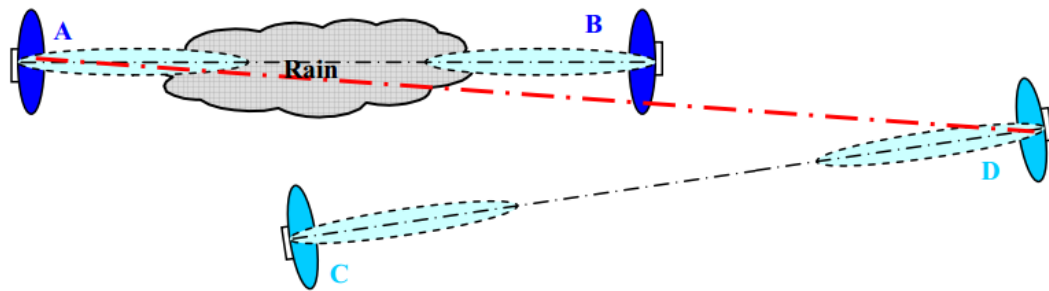

Figure 5: Correlated fading geometry - ATPC power increase at A does not increase interference at D

If the interference path from interfering transmitter to victim receiver, is within the included angle

$\theta$ , as illustrated in Fig. 18, then the interference at D from transmitter A under clear-air conditions

is the highest that will occur. Under clear-air conditions, transmitter A will be using its reduced ATPC power.

**Example 2: Interference entering Victim Antenna near Boresight direction**

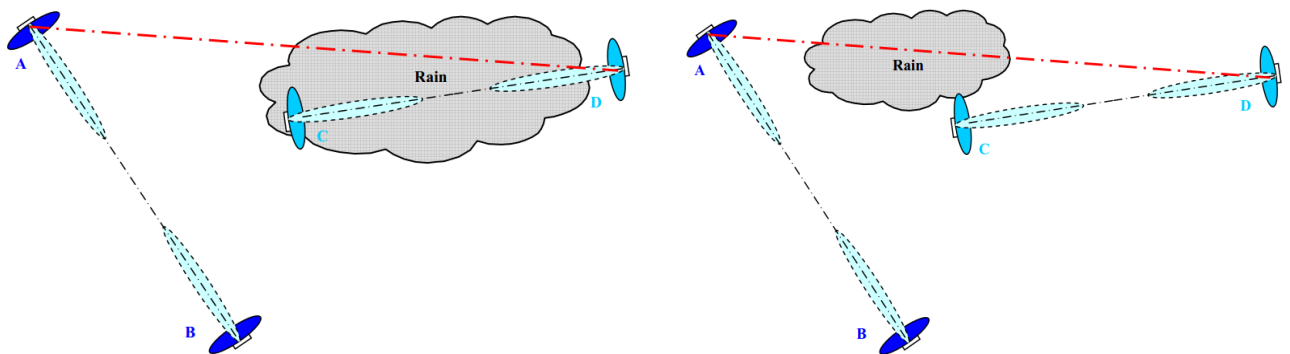

A rain cell that affects the desired signal path (C-D link) attenuates the desired signal, and attenuates the interference signal by an equal amount (figure 19).

A rain cell that occurs beyond the desired link (figure 20) may attenuate the interference signal while not affecting the desired signal.

Therefore, the interference level and C/I ratio that are calculated under clear-air conditions are worst-case values that will not be degraded by the rain.

**Example 3: Desired and Interference Propagation Paths within a Rain Cell**

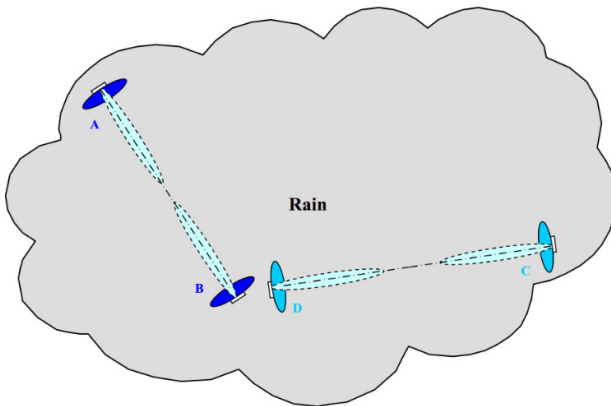

Figure 8: Correlated fading geometry – equal rate-of-fading (dB/km) of interference and desired signals

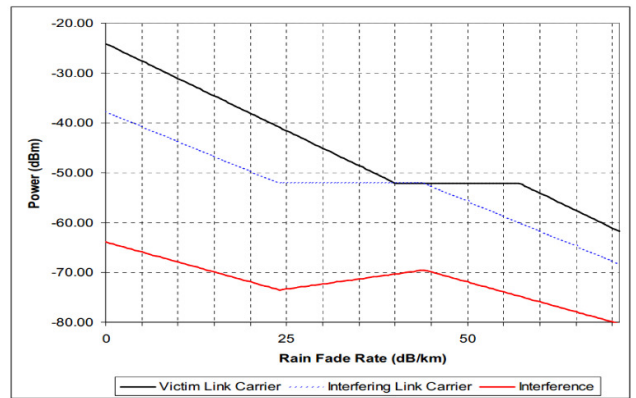

Figure 9: Equal rate (dB/Km) fading

In this case, C/I analysis is recommended. Based on the minimum 2km rain cell diameter, the analysis is recommended when the interfering link, the victim link, and the path of inference are located within 1km of the victim receiver. For example, the calculation is done for 9dB/km of the rain attenuation, and it seems that the lighter rain regime could be more critical causing the link to fail [15].

For this situation, C and I may be plotted together to analyze the C/I that exists with the rain fading. Figure 4-9 shows an example of such a plot for an arrangement of links where the victim link is longest and the path of interference is shortest, with the interfering link in between (all links within a 1-km radius of the victim receiver). Both links in this example are using ATPC that operates in a dB-

for-dB fashion to hold the link carrier level at 10 dB above threshold. For the links not to interfere, C/I must be greater than T/I for the range of rain rates that cause C to fade from the clear-air value to the static threshold. It should be noted that the worst C/I in this example does not occur at either

endpoint (clear-air or threshold) but rather in between at a rain attenuation rate of 44 dB/km. In general it is necessary to analyze the entire range of fading of the victim receiver. However, with this type of ATPC this amounts to checking two additional “critical points” defined by the operation of the ATPC on the interfering and victim links. The additional points that could, depending on the geometry, have the minimum C/I value are where the ATPC of the victim link begins to increase the

transmitter power and where the interfering link ATPC reaches maximum power.

### 9.3 Inter Link Analysis of Collocated Systems (Near End)

#### *The Near End Interference Calculations*

The interference scenario where the transmitter of link-2 at site A interferes the receiver of link-1 at site A is avoided in FDD operation by use of frequency planning. The network designer will typically design the network such that both transmitters at one site will use one frequency band (e.g. 81-86GHz) while both receivers will use the other frequency band (e.g. 71-76GHz). This interference scenario is unique to TDD operation. However, it can be shown both theoretically and experimentally that the interference level between a TDD system and another TDD or FDD system collocated at the same hub site and operating in the same frequency band is below the threshold required to prevent interference between them. This is mostly a result of the high antenna directivity, low transmit powers, large transmit bandwidths, and noise-figure that are all typical

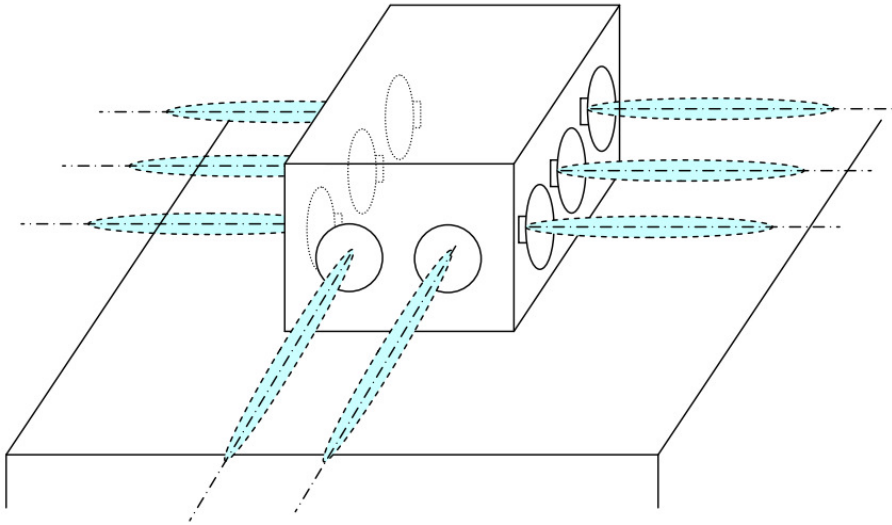

Figure 10: Co-deployment of transmitters on a single rooftop in a hub-and-spoke geometry

#### *TDD Interference generation (TDD Interferes to TDD or FDD)*

In this section we consider a case where a TDD system is mounted on the same pole with another TDD or FDD system. The two systems are assumed to be mounted directly above each other (see the diagram below) in a hub tower and operating in the same frequency channel. Note that in practice it

is more than likely that the units will NOT be mounted in the exact direction and/or will NOT operate at the same frequency.

Figure 25 shows the basic reference model for the calculations of the interference.

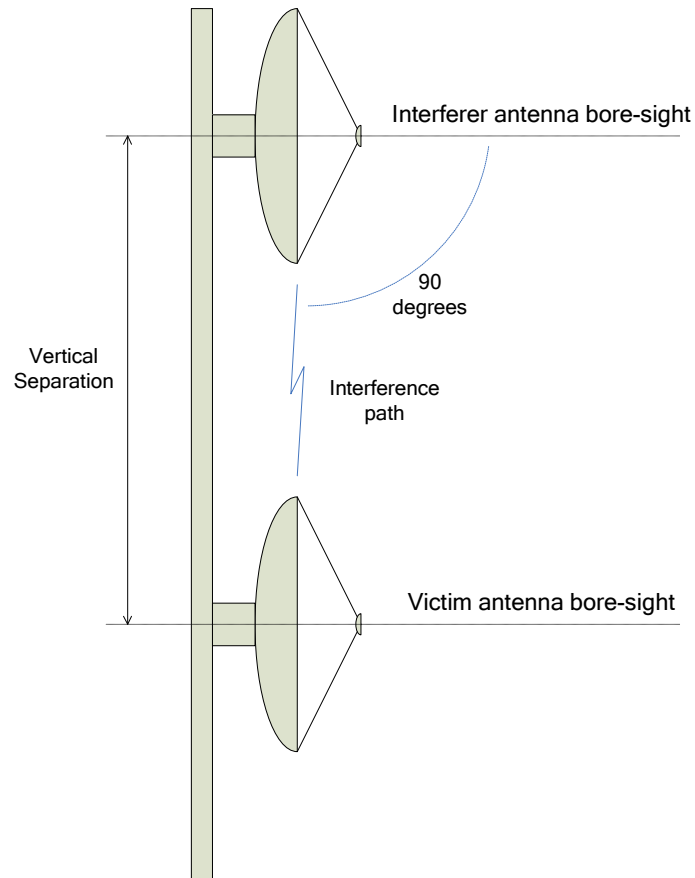

Figure 11: Reference Model for collocated antenna interference calculation

The interference analysis assumes the following system specifications:

1. Antenna gain: above 38 dBi
2. Antenna gain at 90° below -7 dBi (ETSI class 2 compliant)
3. Transmitting power +10dBm
4. Noise Figure (NF) 10 dB
5. Operational Bandwidth 500 MHz

Assuming that the two units are mounted two meters apart and the operation bandwidth is 500MHz, we may calculate the interference power per Hz at the victim receiver using the following

formula:



$$P_{Interference} = P_{TX} + G_{TX} + G_{RX} - 20 \log \left( \frac{4\pi D[m]}{\lambda[m]} \right) - 10 \log(BW[Hz])$$

Where  $G_{TX}$  and  $G_{RX}$  are the interferer and victim antenna gains at  $90^\circ$  respectively which equal -7dBi.  $D$  is the vertical separation distance of 2 meters between the units and  $\lambda$  is the wavelength which equals to 0.0042m at 71 GHz. If we substitute, we get:

$$P_{Interference} = 10 - 7 - 7 - 75.5 - 87 = -166.5 \text{ dBm/Hz}$$

This figure may be compared to the thermal noise at the receiver. If we assume the noise figure of 10dB, the noise power at the receiver would be:

$$P_{Noise} = -174.5 + 10 = -164.5 \text{ dBm/Hz}$$

Thus, we can calculate the worst case interference to be:

$$P_{Noise} + P_{Interference} = 10 * \text{Log} \left( 10^{-164.5/10} + 10^{-166.5/10} \right) = -162.4 \text{ dBm/Hz}$$

It can be seen that the worst case interference (i.e. without any frequency planning) will degrade the noise floor by about 2.1 dB which is small compared to the overall link budget. It should be noted that by using ETSI compliant class 3 antennas in the TDD system, the interference level can be reduced by 10dB, thus practically eliminating it.

### ***TDD Interference susceptibility calculations***

In this section we consider a case where a TDD system and another TDD or FDD system are mounted directly above each other (as depicted in the diagram above) in the hub tower and operating on the same frequency. Note that in practice it is more than likely that the units will NOT be mounted in the exact direction and/or will NOT operate at the same frequency.

The following interference analysis assumes the following specifications:

1. Antenna gain:                   above 38 dBi
2. Antenna gain at  $90^\circ$        below -7 dBi
3. Transmitting power       +17dBm
4. Noise Figure (NF)         13 dB
5. Operational Bandwidth 500 MHz

In this scenario the transmitting power has been raised to 17dBm to account for high-end, high-power FDD systems that are available in the market, while the NF has been raised to 13dB to account for the slightly degraded NF typical of TDD systems in these frequencies (caused by the presence of a TX/RX switch).

Assuming that the two units are mounted two meters apart and the operating bandwidth is 500MHz, we may calculate the interference power per Hz at the victim receiver using the following formula:

$$P_{Interference} = P_{TX} + G_{TX} + G_{RX} - 20 \log \left( \frac{4\pi D[m]}{\lambda[m]} \right) - 10 \log(BW[Hz])$$

Where  $G_{TX}$  and  $G_{RX}$  are the interferer and victim antenna gains at 90° respectively which equal -7dBi.

$D$  is the vertical separation distance of 2 meters between the units and  $\lambda$  is the wavelength which equals to 0.0042m at 71 GHz. If we substitute, we get:

$$P_{Interference} = 17 - 7 - 7 - 75.5 - 87 = -159.5 \text{ dBm/Hz}$$

This figure may be compared to the thermal noise at the receiver. If we assume the noise figure of 13dB, the noise power at the receiver would be:

$$P_{Noise} = -174.5 + 13 = -161.5 \text{ dBm/Hz}$$

Thus, we can calculate the worst case interference to be:

$$P_{Noise} + P_{Interference} = 10 * \text{Log} \left( 10^{-162.5/10} + 10^{-159.5/10} \right) = -157.7 \text{ dBm/Hz}$$

It can be seen that the worst case interference will degrade the noise floor by about 4.2 dB which leads to approximately 4.2dB lower margin. Even though this amount of degradation cannot be considered negligible, it is important to note that this calculation considers high transmitting power, small spatial separation, and no angular separation and no frequency planning in the form of using adjacent frequency channels or different polarization. It is thus safe to assume that in real life scenarios interference would be rare, and if it does occur, it should be easy to solve. Additionally, it should be noted that by using ETSI compliant class 3 antennas in the TDD system, the interference level can be reduced by 10dB, thus practically eliminating it.

### Conclusion

The interference analysis conducted in the previous sections shows that the operating conditions of wireless equipment at E-band frequencies, and primarily the high-directivity ('pencil-beam') antennas used in it, enable sharing the band between TDD and FDD systems without need to worry about near side interference. It has been shown that it suffices to limit the TDD system to +10dBm in order to ensure it will not cause any significant near-side interference a collocated TDD or FDD system, even without any frequency planning. When a TDD system is a victim of interference, the worst case degradation it may suffer from a collocated high-power FDD system is relatively small (>5dB). Should such degradation occur in practice, it may be easily overcome by using an adjacent frequency channel, using an alternate polarization, or using ETSI class 3 compliant antennas on the TDD system.

The vast utilization of microwave links for mobile backhaul and in particular the increase in the number of those alongside with the increase in no. of cell sites deployed during the last decades of mobile operations, resulted in spectrum congestion.

At the same time, new generations of broadband and mobile services call to exponentially increase the available backhaul bandwidth.

Thus, wherever fiber is not an option, service providers will recur to the newly open and regulated E-band spectrum. The 71-76 GHz and 81-86 GHz bands, allow the introduction of cost-effective backhaul networks based on a new category of products to deliver the high data rates required by the transport networks.

Eventually, wireless spectrum is a scarce resource, and a wise spectrum planning will avoid the congestion of this band in the future to come.

Such wise use will require a thorough consideration of the duplexing mode to be implemented in any scenario to be deployed.

#### 9.4 Interference risk from Vehicular RADARs in 76-79 GHz

In this section, we will discuss interference risk from the out-of-band and spurious emissions from vehicle radar operating in the 76 GHz to 81 GHz range on fixed wireless point-to-point link operating in the 71-76 and 81-86 GHz band.

Firstly, we define out-of-band emissions and spurious emissions. *Out-of-band emissions* are residual emissions related to the intentional emissions radiated by the antennas on the frequencies immediately outside the permitted range of frequencies which may result from the modulation process. *Spurious emissions* are emissions radiated by the antenna or the transmitter cabinet on a frequency, or frequencies, outside the permitted range of frequencies occupied by the transmitter. Spurious emissions include harmonic emissions, parasitic emissions, intermodulation products, but exclude out-of-band emissions

While there is no specific requirement for the minimal level of spurious and out-of-band emissions from the vehicular radar operating in the 76-77 GHz band that has been specified by the ACMA, for the purposes of the interference risk analysis, the FCC and ETSI recommended levels [25,26] will be used. The ACMA may consider including such requirements, or impose more rigorous ones, within a future revision of the low interference potential device (LIPD) class license to minimize the risk of interference in adjacent spectrum.

The recommendations for vehicle radar system operation within the band 76-77 GHz are defined in the FCC report and order [26]. It is specified that the power density of any emission outside the operating band shall be considered to consist solely of spurious emissions. Furthermore, the limits for radiated emissions outside the operating band and between 40 GHz and 200 GHz, measured at a distance of 3 m from the exterior surface of the radiating structure, shall not exceed the limits given in the Table 7 [26].

| Type of vehicle mounted sensors | Power density limit [pW/cm <sup>2</sup> ] |
|---------------------------------|---|
|---------------------------------|---|

|                                      |     |
|--------------------------------------|-----|
| forward-looking sensors              | 600 |
| side-looking or rear-looking sensors | 300 |

Table 7: FCC limits for spurious emissions

The requirements for vehicle radar operation in the frequency range between 76 GHz to 77 GHz are also specified by ETSI [26]. It is defined that the mean power spectral density radiated outside

the 76 GHz to 77 GHz band shall not exceed the values shown in Table 8 [26].

| Frequency range [GHz] | Maximum mean power spectral density (dBm/MHz) |
|-----------------------|---|
| 73.5 -76              | 0   |
| 77 – 79.5             | 0   |

Table 8: ETSI limits for out of band radiation

In addition, the effective radiated power spectral density of any radiated spurious emission shall not exceed the values given in Table 9 [26].

| Frequency range [GHz] | Limit value for spurious radiation (dBm/MHz) |
|-----------------------|--|
| 40 – 100              | -30  |

Table 9: ETSI limit for radiated spurious emissions

The interference risk from the vehicular radars can be reduced by implementing antennas with narrow-beam radiation pattern for vehicle radar as well as for the link. However, the above limits will apply only for the fundamental frequency band, for vehicle radar in the 76-77 GHz band. Furthermore, the radars will operate while vehicle are travelling uphill, downhill, and around curves, so specifying beam-width limits will not stop the radar beam from illuminating off road objects.

As a worst case scenario, the link budget calculation is presented in Table 10 when the interferer is the vehicle radar. The interference analysis is based on the Wireless Communication Association recommendation [23] when the out-of-band emissions are restricted as in Table 8.

| Parameter                   | Link            | Interferer-to-link |
|-----------------------------|-----------------|--------------------|
| Carrier frequency [GHz]     | 75.75           | 75.75              |
| EIRP [dBm]                  | 53 <sup>6</sup> | 24                 |
| Bandwidth [MHz]             | 250             | 250                |
| NF [dB]                     | 8               |                    |
| Noise power [dBm]           | -81.8           |                    |
| Rain attenuation [dB/km]    | 9               |                    |
| Path length [km]            | 1.5             | 1                  |
| Received antenna gain [dBi] | 50              | 50                 |
| Received power [dBm]        | -38.0           | -56.0              |
| Received C/(N+I) [dB]       | 18.0            |                    |
| Required SINR [dB]          | 14              |                    |
| Required T/I [dB]           | 19.9            |                    |
| Link margin                 | -1.9            |                    |

Table 10: Interference Risk

<sup>6</sup> The value is chosen as the maximum transmitter output level which does not need to employ ATPC based on the WCA recommendation [23]

The interference analysis is based upon a comparison of C/(N+I) in service with manufacturer-specified T/I limits for a digital receiver. The static threshold of a digital receiver, T, is defined as the manually faded (with attenuators) receive carrier level that produces a bit-error-rate (BER) of

$10^{-6}$ . Values of T/I are roughly 6 dB greater than the theoretical threshold values of C/N under the assumption that the interferer is a (worst case) thermal-noise like interference with a bandwidth less or equal to that of the desired signal. Theoretical C/N requirement for some common schemes

include OOK or BPSK (C/N=13 dB), QPSK (13.5), 4FSK (17.5 dB) and 16QAM (20.9 dB), and hence T/I is taken to be 19.9 dB.

Based on the interference link analysis illustrated in Table 10, if the link is partially affected by light rain, the received carrier to interference-plus-noise ratio C/(N+I) may fall 1.9 dB below the required level causing the link to fail. Although, the interference to a link is likely to be restricted to very short periods of time from an individual vehicle, with increasing traffic flow of vehicles equipped with automotive radar operating in the 76-77 GHz band, the link availability of wireless point-to-point link operating in the 71-76 and 81-86 GHz band might be significantly degraded.

The interference risk from vehicular radar can be reduced in several ways. Firstly, by the implementation of automatic transmit power control (ATPC). In such a way, the ATPC system

could provide protection against rain outage, and in the particular case illustrated in Table 10, protection against harmful vehicle radar interference.

Secondly, the implementation of guard bands will provide greater opportunity for the natural roll off of emissions outside the band. It is the implementation of these guard bands as proposed by ETSI and Ofcom [16, 19] that might explain why interference from vehicular radar is not discussed.

## 9.5 Interference risk to Radio Astronomy

The 76-86 GHz band is protected with the ITU footnote 5.149. But, only 81-86 GHz band is potentially subject to interference from the high capacity fixed point-to-point links. Hence the protection of the radio astronomy services within the band 81-86 GHz will be the focus of analysis in this section.

| Location | Latitude/Longitude | Frequency band | Spectral power flux-density <sup>2</sup> |
|----------|--------------------|----------------|--|
|          |                    |                |  |
|          |                    |                |  |

Table 5: Radio astronomy observatories, their locations, geographic co-ordinates, operating frequency bands and protection requirements

<sup>2</sup> Spectral power flux density is determined based on the Recommendation ITU-R RA.769 [29] for the 81-86 GHz band.

In [30], notification zones are defined for apparatus licensed services around radio astronomy facilities. The purpose was to prescribe a process for notification of prospective frequency assignment to apparatus licensed services that might impede or degrade the operation of radio astronomy facilities. However, considering that the 81-86 GHz band is not taken into consideration in [30] it is necessary to calculate the notification zone radius for the 81-86 GHz band that would be adequate to avoid possible interference arising from the use of the fixed point-to-point links in the 71-76 and 81-86 GHz bands.

Based on the Recommendation ITU-R RA.1031-1 [31], transmission loss can be calculated as

$$L_b(p) = P_t + G_t + G_r - P_r(p)$$

In this analysis, transmission loss comprises free-space propagation loss and atmospheric absorption loss.

|   |                      |
|---|----------------------|
| $P_t$ - transmitting power level (dBW)  | 0dBW                 |
|   |                      |
| $G_t$ - gain (dBi) of the transmitting antenna in the direction of the radio astronomy antenna  |                      |
| $G_r$ - gain (dBi) of the receiving antenna in the direction of the transmitter   | 0dBi <sup>4</sup>    |
| $P_r(p)$ – maximum permissible interference power (dBW) in the 81-86GHz band to be exceed for no more than p% of time at the receiver input | -130dBW <sup>5</sup> |
| Atmospheric absorption  | 0.5dB/km             |
| Notification zone radius  | 25km                 |

Table 6: Input parameters for the notification zone radius calculations

<sup>3</sup> Antenna gain is taken as typical from the manufacturer's product specification lists (Section 3).

<sup>4</sup> Based on the Recommendation ITU-R RA.769 [29], for the assessment of interference to radioastronomy from transmitter used for terrestrial radiocommunications, a value of 0 dBi is adopted for the gain of the radioastronomy antenna in the direction of the horizon.

<sup>5</sup> Many radioastronomy measurements can tolerate levels of interference from a shared service which exceed these thresholds for 10% of the time. Maximum permissible interference power is found from spectral power flux density [31] for the 81-86 GHz band.



## 10. License Considerations

### **Overseas Licensing arrangements**

The unique characteristics of the links operating in the 71-76 GHz and 81-86 GHz bands provide an opportunity to utilize more flexible licensing arrangements and several different approaches have been taken overseas.

#### **Flexible Licensing Approach (USA and possibly Canada, Mexico)**

The FCC has adopted a flexible and innovative regulatory framework for the 71-76 GHz and 81-86 GHz bands. Rights with regard to specific links are established based upon the date and time of link registration. herefore, a first-in-time criterion is adopted in order to protect the first-in-time registered or incumbent links.

Furthermore, all licensees are required to obtain and submit an interference analysis to a third party manager as a part of link registration. The aim is to minimize the adverse economic impact on licensees, including those that are small entities. In adopting the interference-analysis requirements, the cost and benefits of imposing an interference analysis requirement are considered, especially for small entities. In an FCC survey, it was found that the cost of performing such analyses would be relatively small, particularly when compared with the benefits of preventing harmful interference to existing operations for all licensees. Three database managers, FFI, Micronet and Comsearch use distinct but centralized databases, offering the choice to the user community while ensuring a centralized format for available link information.

#### **Light Licensing Approach (UK and some other European countries)**

The deployment under a license exempt basis could result in unacceptable interference and would be unlikely to lead to optimal use of the spectrum, particularly considering the high availability applications proposed to be used in the bands.

On the other hand, the potential for interference is likely to be small in the bands due to the 'pencil beam' signal characteristics of the fixed wireless systems. Therefore, a simple mechanism which enables individual 70/80 GHz links to gain protection from interference can be accomplished by the implementation of a centralized database with a registration system with a first come first served data and time record essentially forming the basis for protection.

#### **Fully Licensed Approach (Finland, Switzerland and Estonia)**

**The 71-76 and 81-86 GHz bands are fully licensed. The coordination is necessary to ensure that services neither suffer from, nor cause, interference.**

## 10.1 Licensing Options in India

### Apparatus licensing

Traditionally, apparatus licenses are issued to authorize the operation of fixed point-to-point services in the microwave bands. Apparatus licenses are usually issued 'over the counter', and require payment of an annual tax as well as an administrative charge. Apparatus licensing for point-to-point services also involves detailed frequency coordination.

This framework serves to minimize interference between fixed service users and recovers economic revenue for the use of the public resource commensurate with spectrum denied to others.

An annual tax is applicable for each apparatus license. The tax is based on several factors: the bandwidth access (\$ per kHz), the spectrum location and the geographic location. Apparatus licenses also attract an issue charge (to cover the cost of frequency assignment and administration), and a renewal charge in subsequent years. In the case of high capacity fixed links the issue charge could, based on the existing fee schedule, work out to several (tens of) thousands of dollars per link. However, the tax component for some apparatus licenses is set at a fixed amount.

This model applies in India for ISP's, and the cost for a 28MHz license is Rs 2.88L, and if the same formulas will be applied to the 250Mhz channels of the E-Band, we could get to numbers between Rs 5-20L for equipment that can mostly serve ranges of below 1Km.

### Royalty based licensing

Mobile operators in India get specific microwave channels ("spots") per circle, for which they pay a percentage of a "modified" AGR, and the percentage per channel goes up as the operator gets more channels per circle. In this case no coordination is needed as the operator has his own channels. With some of the operators use 5-8 channels in cities, the burden of 1.1% to 2.3% is serious, not to mention the shortage in such channels

|              | Spectrum charges as % of AGR       | Cumulative spectrum charges as % of AGR |
|--------------|------------------------------------|---|
|              | Lower Frequencies (28 MHz, paired) | Lower Frequencies (28 MHz, paired)      |
| 1st carrier  | 0.15%                              | 0.15%                                   |
| 2nd carrier  | 0.20%                              | 0.35%                                   |
| 3rd carrier  | 0.20%                              | 0.55%                                   |
| 4th carrier  | 0.25%                              | 0.80%                                   |
| 5th carrier  | 0.30%                              | 1.10%                                   |
| 6th carrier  | 0.35%                              | 1.45%                                   |
| 7th carrier  | 0.40%                              | 1.85%                                   |
| 8th carrier  | 0.45%                              | 2.30%                                   |
| 9th carrier  | 0.50%                              | 2.80%                                   |
| 10th carrier | 0.55%                              | 3.35%                                   |
| 11th carrier | 0.60%                              | 3.95%                                   |

This AGR method cannot be used for E-Band for two reasons:

- As we saw in section 8.1, there are not enough channels to give to operators on an exclusive basis. Due to the extremely wide channels needed in E-band, requiring 2 to 4 channels of 250 MHz each, AGR based scheme cannot be practically implemented as for lower microwave bands where each operator is assigned specific spots in a circle on exclusive basis. With 4.75 GHz of spectrum, allowing for 1000 MHz channels (as required by many vendors) will allow only 4 independent channels per circle, and working with 500 MHz will allow for 9 independent channels.
- Since E-Band links are going to be implemented in urban short overlays over the existing microwave structure, initial deployments will contribute only to part of the operator revenues, therefore royalty based pricing cannot be practically implemented, as it will result with a too high cost per link when one calculates the circle AGR versus the number of links to be deployed. **The bottom line is that E-Band links cannot be priced on royalty basis, even at very low percentage.**

**Per link licensing seems to be the only way to benefit from the high re-usability of the spectrum. Low pricing is needed in order to encourage the usage of this spectrum.** The licensing process has to facilitate for the following requirements:

- Fast and easy online access to register the link
  - Registration of the link
  - Interference analysis (on line!)
  - Online payment
- Easy, online access to issue import licenses
- Channel allocation will be done by the system
  - The system will try to populate one channel, or set of adjacent channels, and only when interference is detected will allocate the next (set of) channel.

## 10.2 India Pricing

Since E-Band links are going to be implemented in urban short overlays over the existing microwave structure, initial deployments will contribute only to part of the operator revenues, therefore royalty based pricing cannot be practically implemented, as it will result with a too high cost per link when one calculates the circle AGR versus the number of links to be deployed. **The bottom line is that E-Band links cannot be priced on royalty basis, even at very low percentage.**

The current per-link pricing scheme enforced in India is calculated according to the following formula such that a 28 MHz channel, short range (up to 5 km) link would cost 288,000 Rupees (~US\$ 5,760):

$$R = M \times W \times C$$

Where:

- **M** – Constant multiplier depending on the distance of the link. The shorter the link the small M is (for example: M=1200 for links up to 5 Km and M=2400 for links up to 25 Km). **We suggest M value of 600 for links of up to 2Km.**
- **W** – Weighting factor decided by the adjacent channel separation of the channeling plan (for example: W=30 for adjacent channel separation above 2 MHz and W=120 for adjacent channel separation greater than 7 MHz but less than or equal to 28 MHz (since from 2MHz to 28MHz W was increased by a factor of 4, a similar proportionate factor when going from 28MHz to 250MHz would be 2.55). **We suggest W=360 for a 250MHz Channel**
- **C** – Number of RF channels used. **C= 2 for 500MHz TDD or 250MHz FDD systems and 8 for 1000MHz FDD systems**
- **E** – We propose a new correction factor, based on the re-use and spectral efficiency (as detailed in Annex 11.4 - Method 1) and **suggest setting it at 1/300.**
- Taking these factors together the per-link pricing scheme suggested for the E-band spectrum is as follows:

- **500MHz TDD:  $R = M \times W \times C \times E = 600 \times 360 \times 2 / 300 = 1,440$  (say 1,500) Rupees (~US\$3045)**
- **1000MHz FDD:  $R = M \times W \times C \times E = 600 \times 360 \times 8 / 300 = 5,760$  (say 6,000) Rupees (~US\$120)**

Annex 11.4 provides also a sanity check to show in a different way (Method 2) that the same 2\*250MHz channel should cost 1,350 Rupees which is along the same numbers as suggested here.

If we want to compare to international pricing (see details in Annex 11.4), as seen in the table in the next page, we can add a few reasons for the benefit of the low pricing in India. The cost of the equipment in India is significantly lower than the cost in EU and US, so the annual per link cost should be proportional to that. The Tariffs in India are the lowest in the world, so the network

| Frequency (GHz) | 15      |          | 23      |         | 38      |         | 71-76/81-86 |         |         |
|-----------------|---------|----------|---------|---------|---------|---------|-------------|---------|---------|
| Bandwidth (MHz) | 28      | 56       | 28      | 56      | 28      | 56      | 250         | 500     | 1000    |
| India           | \$2,000 |          | \$2,000 |         |         |         | \$30        | \$60    | \$120   |
| USA             | \$230   | \$230    | \$230   | \$230   | \$230   | \$230   | \$7.5       | \$7.5   | \$7.5   |
| UK              | \$1,650 | \$3,290  | \$1,150 | \$2,300 | \$1,000 | \$2,000 | \$80        | \$80    | \$80    |
| Australia       | \$2,690 | \$5,380  | \$2,690 | \$5,380 | \$1,470 | \$2,940 | \$190       | \$190   | \$190   |
| Poland          | \$2,900 | \$5,800  | \$1,450 | \$2,900 | \$580   | \$1,160 | \$15        | \$30    | \$60    |
| Switzerland     | \$5,730 | \$11,550 | \$4,770 | \$9,540 | \$3,820 | \$7,635 | \$850       | \$1,700 | \$3,410 |
| Ireland         | \$1,865 | \$2,330  | \$1,400 | \$1,750 | \$1,025 | \$1,285 | \$235       | \$235   | \$235   |

generate less revenues per Equipment and per spectrum portion use.

## 11 Recommendations for E-band pricing

The introduction of regulatory arrangements supporting the use of the 71-76 and 81-86 GHz bands would facilitate the use of a range of new high bandwidth short range services. However the use of traditional coordinated bandwidth based fee and license structure would unnecessarily hinder deployment of these new services.

As we can see in 9.2, in FY 2012 VAS revenues accounted for 12%-15% of total operator revenues, although broadband subscribers accounted for only 1.5% of mobile subscriber base.

The AGR part of Broadband (VAS) can be assumed as 13% of the total AGR So, In terms of 2012 numbers the AGR generated from VAS/Broadband is listed below (in red):

| 2012 AGR | VAS | 2013 VAS AGR |       |
|----------|-----|--------------|-------|
| Rs CR    | %   | Rs CR        | \$M   |
| 87,127   | 13% | 11,327       | 2,265 |

Current license and Spectrum charges range from 15% in metro and A circles to 13% in B,C circles. Even if we consider the unified license fees of 6% in the future (new telecom Policy), than with the Spectrum Charges, we will get a 10% of AGR as Government fees

Assuming that free opening of the E-Band can drive Number of installed E-Band links

| Number of installed E-Band links can drive: | ≤1,000 | 5,000 | 10,000 | 50,000 | 100,000 |
|---|--------|-------|--------|--------|---------|
| Broadband Subscribers number multiplied by: | 1      | 2     | 5      | 8      | 10      |
| AGR part of Broadband multiplied by         | 1      | 1.2   | 2      | 3      | 4       |

In the following table, we give an estimate to the potential number of E-Band links as a function of the annual per link spectrum charge that will be decided for this band (grey). We use this number of E-Band links to extrapolate the increase in VAS/Broadband AGR that results from the increase in Broadband subscriptions.

| Annual Per Link Charge | Market potential of E-Band Links per Link Charges | Annual Government Spectrum Charges | VAS & Broadband revenue Increase factor | Spectrum & Licence | Annual Government Broadband Income |       |     |   |
|------------------------|---|------------------------------------|---|--------------------|------------------------------------|-------|-----|---|
| Rs LAKHS               | \$  | #                                  | Rs Cr                                   | \$M                | %                                  | Rs Cr | \$M |   |
| 5.00                   | 10,000  | 500                                | 25.00                                   | 5.0                | 1                                  | 10%   | 0   | 0 |

| Rs LAKHS | \$     | #   | Rs Cr | \$M |   | %   | Rs Cr | \$M |
|----------|--------|-----|-------|-----|---|-----|-------|-----|
| 5.00     | 10,000 | 500 | 25.00 | 5.0 | 1 | 10% | 0     | 0   |

|      |       |         |       |     |     |     |       |     |
|------|-------|---------|-------|-----|-----|-----|-------|-----|
| 1.50 | 3,000 | 1,000   | 15.00 | 3.0 | 1   | 10% | 0     | 0   |
| 0.25 | 500   | 5,000   | 12.50 | 2.5 | 1.2 | 10% | 227   | 45  |
| 0.10 | 200   | 10,000  | 10.00 | 2.0 | 2   | 10% | 1,133 | 227 |
| 0.02 | 30    | 50,000  | 7.50  | 1.5 | 3   | 10% | 2,265 | 453 |
| 0.00 | 0     | 100,000 | 0.00  | 0.0 | 4   | 10% | 3,398 | 680 |

We can clearly see that the Government income from increase in Broadband AGR is by far bigger than any direct income from direct Spectrum Charges, so it's not worthwhile to heavily tax Spectrum charges. Any increase in the direct spectrum charges will risk a huge reduction in income from broadband AGR.

The type of license and access cost for these bands under the proposed management framework would be influenced by a number of factors:

- The nature of propagation in the millimeter wave bands and the possibility of employing highly directional “pencil beam” signal characteristics mean that applications can be implemented with minimal interference concerns, allowing a potentially highly efficient re-use of the spectrum. Thus, reducing co-ordination requirements.
- The availability of wide bandwidths supporting large capacity data rates, with sufficient bandwidth for terrestrial links to compete with or complement fiber optic based access networks.
- Operating path lengths of 1-2 km with high (>99.9%) availability.
- Availability of WPC database for the self-coordination purposes. The WPC database would hold and make available the relevant information required to enable licensees to plan and self-coordinate links in the 71-76 and 81-86 GHz bands. This database would also serve as the reference point for the data and time a link is registered, thereby establishing the time priority of links. Further issues associated with the WPC database implementation for the purposes of the 71-76 and 81-86 GHz band link registration might require further investigation.
- The degree to which the WPC/TEC would become involved in any interference mediation.





## 11.1 Summary of the Recommendations for E Band

India has the potential to be the biggest user of E-Band technology while it is shaping up. This will both drive the mobile broadband infrastructure in India, and also create an opportunity to the Indian market to influence this industry. Since the 71-76 and 81-86 GHz bands are allocated for Fixed Services in the NFAP 2011, the following is suggested:

1. A flexible channel plan should be adopted in a manner that would enable any existing and future equipment of any bandwidth and modulation.
2. Technical Regulations should be drafted in a manner that will facilitate the future use of a very dense overlay of links, especially in the urban areas. It is advised to encourage low power devices, and mandate QoS based Adaptive Rate mechanism to cope with rain attenuation, and provide Technology Neutrality that will enable competition and innovation.
3. A licensing framework based on a link registration system should be adopted recognizing the value and high spectrum reuse potential of the bands. This framework should also be able to guarantee interference free operation of licensees.
4. The WPC database should be the basis for the registration system.
5. To encourage commercial development and efficient use of the 71-76 and 81-86 GHz bands, a fixed fee approach, at a cost of no more than Rs 1,500 per 2X250MHz Channel.
6. To avoid spectrum hoarding made possible by the low fee structure, a rollout obligation should be attached to licenses and a 12 month time limit for achieving the rollout goal might be proposed.

# **Point-to-Multipoint Technology systems ( 10.5, 26, 28Ghz )**

## **Introduction**

This document gives a high-level overview of modern microwave point-to-multipoint (PMP) networks, describing some of the benefits of this technology for common applications such as mobile broadband backhaul. . Yet PMP networks have several drawbacks that limit their use. These drawbacks compare to standard point-to-point (PTP) system are described as well.

Analysis of the 10.5, 26, 28 GHz bands availability and usage in other countries are summarized in this document as well.

The recommendation for the regulatory authority is to license the 10.5GHz, 26GHz and 28 GHz spectrum bands for the use of PTP networks (primary spectrum usage) and of PMP networks (secondary spectrum usage)

## **1. 10GHz, 26 GHz and 28GHz spectrum use in other countries**

## **2. ITU and ECC recommendations describe both PTP and PMP in these bands for valid deployments in these discussed bands. Analysis of the use of different countries in these bands shows that:**

- Many countries have decided to banned PMP and allocate all the spectrum for PTP links only. This is due to the limit usage of PMP which will be described later in this document
- Some countries allocate part of the spectrum for PTP (larger portion of the band) and part of the spectrum for PMP (smaller portion of the band)
- No country found that allocates the entire bands for PMP networks on
- Other bands (different than 10, 26, 28 GHz are not opened for PMP networks at all

In addition to the regulatory bodies implementation, most of today mobile backhaul is done by PTP links rather than PMP.

## **3. Why use a point-to-multipoint architecture?**

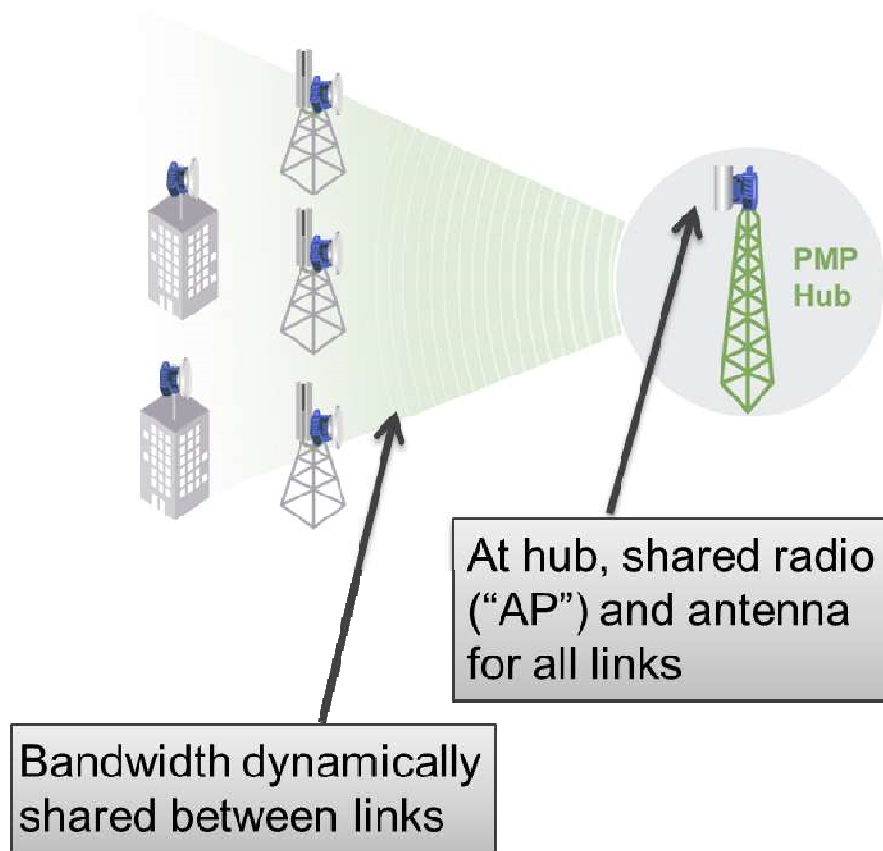
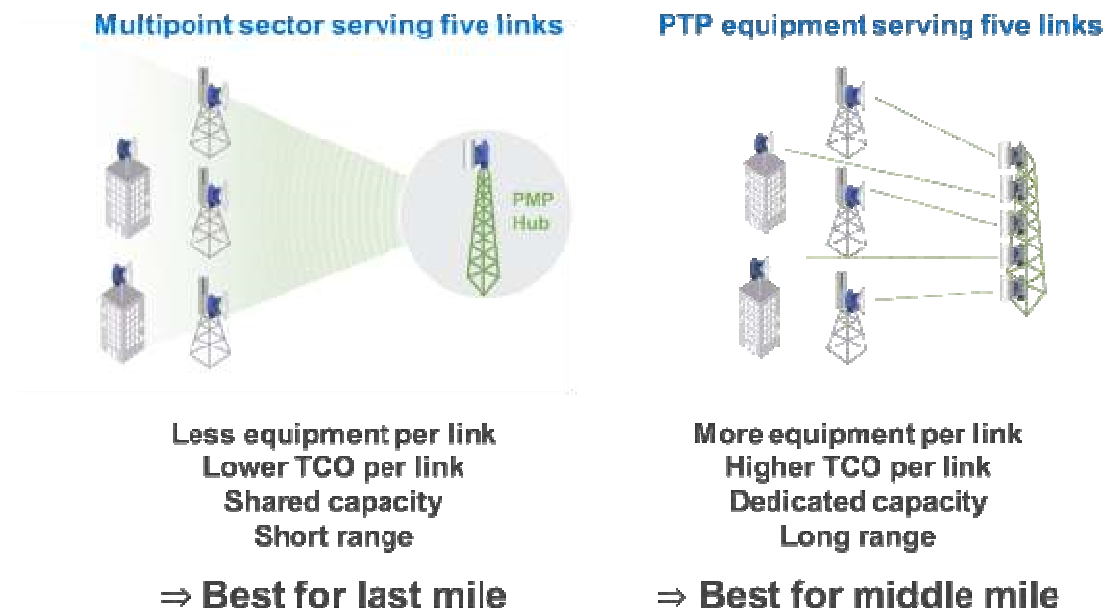

**Figure 1: A point-to-multipoint (PMP) sector serving five links**

The fundamental use case for a PMP architecture is to create links between a hub site (on the right in figure 1) and a set of remote sites. Because the hub equipment and the radio frequency channel between the hub and the remotes are both shared, the cost of the hub equipment and spectrum is amortised over all the links in the sector. This applies to both capital and operating expenses.

The net result is that, when the average number of links in a sector is more than one, a PMP design offers substantially lower per-link costs than alternative designs such as point-to-point (PTP). PMP and PTP designs are complementary to one another and it is usually the case that both technologies will be used in different parts of a backhaul network. A comparison of the characteristics of the two technologies is shown in figure 2.

Because of this significant cost advantage, PMP has become the dominant network design paradigm for most types of wireless network. For instance, WiFi networks operate in a PMP mode, as do GSM and UMTS (3G) mobile telephony networks. Within the telecom space, PMP microwave technology as marketed by CBNL is used by 7 of the top 10 mobile operator groups (as measured by numbers of subscribers). PMP in general is therefore a widely-understood and widely-adopted technology.



**Figure 2: PMP and PTP are complementary technologies**

## **4. Choice of operational frequency**

As described above, the PMP paradigm is applicable across a wide range of frequencies, and equally in licensed or unlicensed spectrum. For backhaul networks and enterprise access there are certain requirements that guide the choices.

### **4.1 Licensed or unlicensed?**

Because the backhaul network is critical to the operation of a mobile telephony network as a whole, typically operators will not use unlicensed spectrum for this application. The nature of unlicensed spectrum is that uncontrolled interference may arise without warning, and without any recourse. This consequently reduces the availability of the backhaul network if such interference is received. The type of service is often referred to as —best effort” and is generally not considered suitable for mobile backhaul other than in exceptional circumstances.

In contrast, licensed spectrum is preferred for backhaul, because the licensing process takes into account the possibility for interference and eliminates it through careful allocation of channels. Thus a true —carrier grade” service can be expected. This is therefore suitable for mobile backhaul, and is also preferred for enterprise access applications, where the higher grade of service will typically lead to reduced customer churn.

### **4.2 Low frequency or high frequency?**

Low frequency RF has certain advantageous physical characteristics in terms of its propagation. Below approximately 6GHz, RF energy penetrates building materials and diffracts around

obstructions. This makes these spectrum bands desirable for the operation of access networks such as 2G and 3G. However these characteristics are not generally required for backhaul. Therefore it is actually disadvantageous to use these bands for backhaul, in general, because the spectrum rented is economically in competition with access demands.

A particular factor is that, because of the desirability for access application described above, the spectrum below 6GHz is highly fragmented. It is therefore complex for regulators to aggregate large contiguous blocks of spectrum for lease to operators, and often would not be economic for the operator in any case. Finally, many of the currently-free bands in this part of the electromagnetic spectrum are proposed as extension bands for LTE, and there is therefore a question mark over the sustainability of use of these bands for the backhaul application.

In contrast, traditional microwave frequencies (approximately between 6GHz and 60GHz) are generally speaking plentiful, with large contiguous blocks available. Because these frequencies are not generally useful for mobile access there is less cross-application competition and these frequencies are likely to remain usable for backhaul for the foreseeable future.

### 4.3 The 10.5GHz, 26GHz and 28GHz bands

These three bands are globally harmonised by the ITU-R for point-to-multipoint usage according to the following recommendations:

| 10.5GHz          | 26GHz                  | 28GHz |
|------------------|------------------------|-------|
| Rec. F. 1568 [1] | Rec. 748-4 Annex 1 [2] |       |

Because of this harmonisation, there is a functional, competitive marketplace in the provision of equipment and services conforming to these standards. There are, therefore, clear benefits for all parties in a territory in aligning to these international standards in terms of enjoyment of the economies of scale and a competitive marketplace.

For the regulator, specifying these regulations results in the spectrum being more likely to be used, which raises public revenue from a common good. For the operator, being able to use readily commercially available technology, with a choice of suppliers, results in competitive pricing. For vendors, being able to service multiple markets with a single product design is more efficient. These benefits are also enjoyed at a remove by the network end-users and general public, through the ability of the operator to offer services at a lower price point.

## 5. Efficient use of spectral resources

The electromagnetic spectrum is a finite resource and it is therefore desirable for it to be used as efficiently as possible. Wasteful use of spectrum can lead to congestion, where insufficient resources are available to deal with increased demand, and (like traffic congestion on the road

network), this kind of congestion is economically harmful to a country overall.

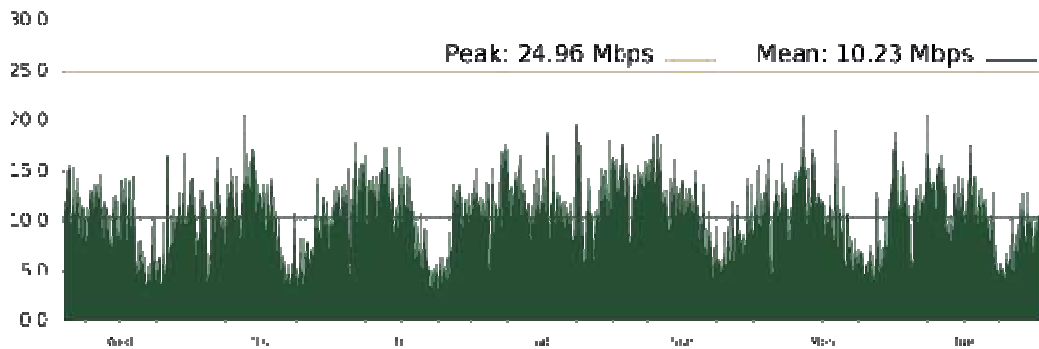

**Figure 3: Actual mobile broadband backhaul traffic with average peak and mean characteristics**

Mobile broadband backhaul traffic is not easy to transport efficiently because of its *bursty* nature, illustrated in figure 3. Rather than a smooth, continuous load of a certain number of megabits per second (Mbps), this type of traffic is characterised by an offered load that varies rapidly with time. One measure of the degree of burstiness of traffic is the *peak-to-mean ratio*. For perfectly smooth traffic of a uniform load, the peak-to-mean ratio is 1: the peak load and the mean load are identical. The larger the peak-to-mean ratio is when greater than 1, the burstier the traffic is. The traffic shown in figure 3 has a peak-to-mean ratio of  $= \frac{24.96}{10.23} = 2.44$ . This is approximately average for data-dominated mobile broadband traffic in 2014.

To understand why this type of traffic is hard to transport efficiently, let us consider dimensioning a wireless link to carry this traffic. If I assume that I do not wish to constrain the traffic because of the size of my link, I must provision as the capacity of the link *at least* the peak offered load—24.96Mbps in this case. However, now consider what will be the utilisation of this link; this is defined as the mean load transported divided by the capacity. Since I only have one source of traffic, the mean load transported on the link must simply be equal to the mean offered load—10.23Mbps in this case. My link utilisation, therefore, is the mean load—10.23Mbps—divided by the capacity—24.96Mbps—or in other words the reciprocal of the peak-to-mean ratio; in this case  $\frac{10.23}{24.96} = \frac{1}{2.44} = 0.41 = 41\%$

We can see, therefore, that purely because of the traffic characteristics, and not because of any defect in the technology, a PTP wireless link carrying mobile broadband traffic will operate at a low efficiency. The figures cited in the NGMN Alliance’s white paper *Guidelines for LTE Backhaul Traffic Estimation* [3] suggest a peak-to-mean ratio of as much as 5.6 for LTE serving cells.

For PMP, the efficiency of spectrum resource utilisation can be dramatically increased. This is possible because a multipoint system allows multiple access to the shared RF medium, and therefore there is more than one source of traffic load. To illustrate this, consider figure 4.

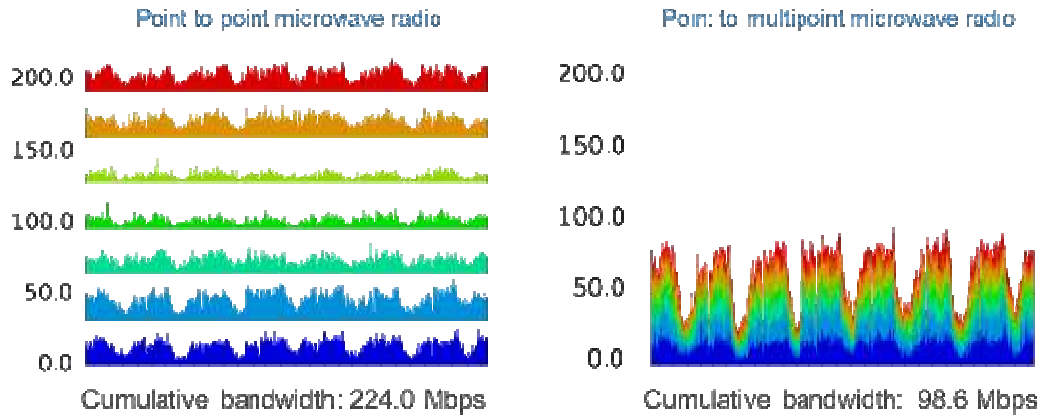

**Figure 4: Comparison of bandwidth needed to transport identical traffic using PTP and PMP**

Here we illustrate, using actual data from a live DC-HSPA+ and LTE network, the dramatically improved efficiency possible with PMP. On the left, we provision PTP links to carry each of seven node Bs' backhaul traffic, requiring a total of 224Mbps. On the right, we carry exactly the same traffic in a PMP sector. Statistically the peaks in bandwidth demand from different node Bs do not occur simultaneously, and therefore it is improbable that a peak in demand from one node B will coincide with a peak in demand from another. Therefore the peak of the aggregated traffic is much less than the sum of the peaks of the individual sources. We can calculate a theoretical figure for the increase in efficiency, known as the *statistical multiplexing gain*, by dividing the sum of the peaks of the individual sources by the peak of the aggregated traffic:

$$\text{statistical multiplexing gain} = \frac{\text{sum of peaks of un aggregated traffic } 177.1}{\text{peak of aggregated traffic } 98.6} = 1.8 \quad \text{for this example}$$

The statistical multiplexing gain is a measure of how much more efficiently the RF resources are used by the PMP system. To illustrate that this is a universal phenomenon, and not a quirk of a chosen set of node Bs, the graph in figure 5 plots the statistical multiplexing gain for one operator's entire network of 3G and LTE base stations backhauled over PMP. The abscissa of the graph is the number of 3G or 3G+LTE sites that are backhauled within a single PMP sector. The network as a whole comprises just under 300 PMP sectors and approximately 1200 remote terminals, each co-located with a 3G or 3G+LTE site.



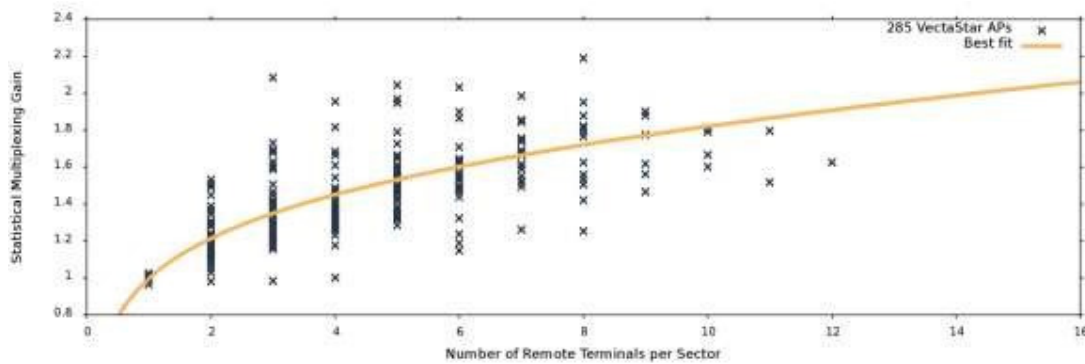

**Figure 5: Statistical multiplexing gain for an entire 3G and LTE network backhauled over PMP**

It is possible to make a number of observations from this graph. First, as expected, if there is only a single remote terminal in the sector, there is unity statistical multiplexing gain – this degenerate case is equivalent to operating the PMP sector as a PTP link. On the other hand, as the number of remote terminals increases, the statistical multiplexing gain increases monotonically. This is intuitive – the more sources of traffic are multiplexed together, the greater the probability that a peak in one source will —cancel with a trough in another source.

The general trend in mobile networks is for an increasing geographic density of base stations or node Bs, because this increases the overall capacity of the network, and is one way to meet the increasing data demands of mobile users. Thus as time goes by, the average statistical multiplexing gain realised by PMP increases, as the trend is to move towards the right on the graph shown above.

## **6. Capacity and frequency re-use support in PTP & PMP**

PTP is a proven carrier grade technology while PMP technology suffers from several drawbacks that limit its penetration to the mobile backhaul market.

PMP networks consist of a hub and several remote terminals that connect to the hub. Since the hub communicates with several terminals its antenna is sectorial antenna which is wide-beam. In comparison PTP links has narrow beam directional antenna.

The antenna gain of sector antenna is quite low. Typical gain antenna is 16dBi at the main beam. In comparison typical PTP directional antenna of 1ft has antenna gain of 38dBi at least at the main beam. The 22dB difference in hub’s antenna reduces the overall link budget of the PMP link by this 22dB. Such significant lower link budget has several circumstances:

1. Having lower link budget reduces the maximum supported link distance. For example, the following use case was examined: 28MHz channel BW, 28 GHz frequency, India rain zone N, link availability of 99.995%, capacity of 220Mbps. The maximum link distance enabled by PTP is 900 meters for the described use case while in PMP the maximum link distance is limited to 400 meters

2. Different approach than point #1 is to translate the 22dB different link budget into different modulation scheme. The modulation scheme difference between PTP and PMP will be at least 6 modulation orders (each modulation order is ~3dB). This low modulation order supported by PMP has significant effect on link capacity and spectral efficiency. For example taking the same use case as before with a link distance of 900 meters, the capacity achieved in PTP is 220Mbps while only 90Mbps at PMP.

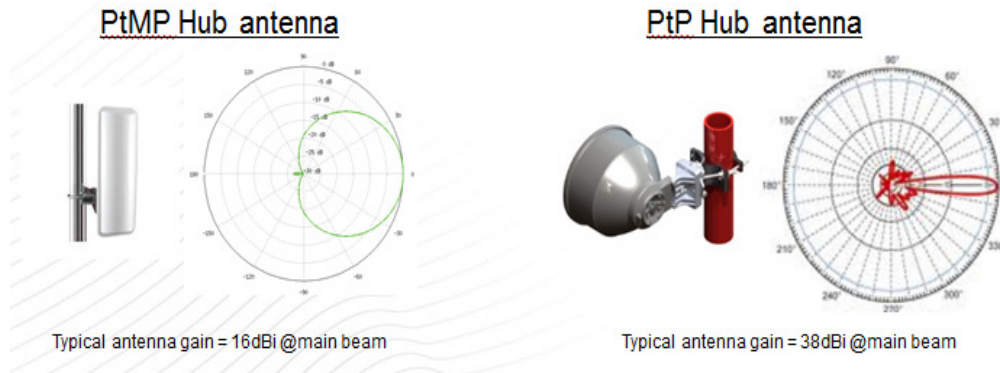

## 6.1 Frequency re-use and spectrum contamination comparison

Another aspect of the PMP Hub's sector antenna is the poor ability of frequency re-use in the deployed network area and high spectrum contamination. In addition the Hub's of different PMP system strongly interfere to each other due to the wide-beam of their antenna in both the transmission and reception. Such mutual interference limit the system capacity beyond the phenomena already described in previous section (section #5) and limit the ability to re-use same frequency between different PMP systems.

Analysis of the different antenna pattern of PTP and PMP system show that PTP enable frequency re-use factor which is 3 times higher than PMP systems. This should be taken into account when considering the pricing of PTP allocation vs. PMP allocation.

## 7. Pricing for PMP spectrum

While it is possible for a regulator to license PMP on a link-by-link basis exactly analogously to PTP licensing, it is more common to license PMP spectrum on an area basis. A common model, explored in ITU-R recommendation ITU-R SM.2012-3 [4], is to charge a fee based on the amount of bandwidth used, the operating frequency and the area serviced:

$$\text{fee} = \text{baseline cost} \times \text{bandwidth in MHz} \times F \times A$$

Here,  $F$  is a factor that varies with the operational frequency and  $A$  is a factor that varies with the area serviced. Example values for  $F$  and  $A$  given in the following tables.

| Lower limit | Upper limit | F    |
|-------------|-------------|------|
| 30 MHz      | 174 MHz     | 1.00 |
| 174 MHz     | 880 MHz     | 0.75 |
| 880 MHz     | 1.8 GHz     | 0.50 |
| 1.8 GHz     | 5.0 GHz     | 0.40 |
| 5.0 GHz     | 10.0 GHz    | 0.30 |
| 10.0 GHz    | 17.0 GHz    | 0.20 |
| 17.0 GHz    | 23.0 GHz    | 0.15 |
| 23.0 GHz    | 30.0 GHz    | 0.10 |
| 30.0 GHz    | -           | 0.05 |

| Lower limit             | Upper limit             | A   |
|-------------------------|-------------------------|-----|
| -                       | 1 km <sup>2</sup>       | 0.6 |
| 1 km <sup>2</sup>       | 10 km <sup>2</sup>      | 2   |
| 10 km <sup>2</sup>      | 100 km <sup>2</sup>     | 6   |
| 100 km <sup>2</sup>     | 1,000 km <sup>2</sup>   | 18  |
| 1,000 km <sup>2</sup>   | 10,000 km <sup>2</sup>  | 56  |
| 10,000 km <sup>2</sup>  | 100,000 km <sup>2</sup> | 180 |
| 100,000 km <sup>2</sup> | 500,000 km <sup>2</sup> | 400 |
| 500,000 km <sup>2</sup> | -                       | 600 |

## Conclusion for PTP and PMP systems

PTP networks has higher capacity, support higher link distance, better spectrum re-use factor and lower interference. All of these make the PTP the Operator's major choice for mobile backhaul deployments.

We recommend to open the 10.5GHz, 26GHz and 28 GHz for use in India while allocate the spectrum primarily to PTP and secondary to PMP. IN addition a contamination factor should be taken into account which makes the PMP frequency channel fee higher than PTP frequency channel.

### Anil Prakash

Secretary General  
Broadband India Forum  
Suite 304, Gagan Deep  
12, Rajendra Place  
New Delhi- 110008, India  
Mobile +91-98111 55846,  
Tel: +91-11-2575 7128  
Fax: +91-11-25757129  
Skype ID:anil.prakash  
email. [anilprakash@yahoo.com](mailto:anilprakash@yahoo.com) , [anilprakash@gmail.com](mailto:anilprakash@gmail.com)  
Web site: [www.iptvforum.org.in](http://www.iptvforum.org.in)