

venu@incois.gov.in

4:23 PM (22 hours ago)



to me, adgmn, Sheno, Pattabhi, murali

Dear Sir,

I am herewith sending the **comments on TRAI Consultation paper " Next Generation Public Protection and Disaster Relief (PPDR) communication Networks"**

1. During the events of natural calamities the mobile/Cell towers, which are mass media of communication between the people is adversely affected thereby crippling the last mile connectivity.

It is advisable to interlink mobile/cell towers of all Telecom providers as a single entity and also by usage of satellite based mobile phones to provide the last mile connectivity.

2.The Satellite -based (compact brief case model VSAT) communication terminals are readily available in market (Ext-C and Ku Band) for uninterrupted seamless voice and data connectivity.

3. The HF communication terminal (backpack) can be used for voice and small text messages.

Please refer to the guidelines issued by NDMA vide its National Disaster Management Guidelines issued on February 2012 in which each and every aspect of communications in the event of a disaster is explained(the document attached).

With best Regards

V.Venu Gopala Rao,
Scientist

Indian National Centre for Ocean Information Services (INCOIS)

"Ocean Valley", Pragathi Nagar (BO),

Nizampet (SO),

Hyderabad - 500 090

Andhra Pradesh, INDIA

Tel : +91 40 23886096,Fax: +91 40 23895001



NATIONAL DISASTER MANAGEMENT GUIDELINES

NATIONAL DISASTER MANAGEMENT INFORMATION AND COMMUNICATION SYSTEM

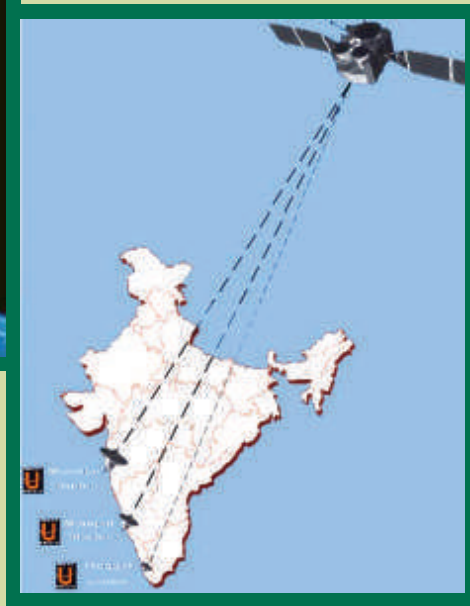

February 2012



NATIONAL DISASTER MANAGEMENT AUTHORITY
GOVERNMENT OF INDIA

National Disaster Management Guidelines

National Disaster Management Information and Communication System

National Disaster Management Guidelines- National Disaster Management Information and Communication System (NDMICS)

A publication of:

National Disaster Management Authority
Government of India
NDMA Bhawan
A-1, Safdarjung Enclave
New Delhi-110 029

ISBN:978-93-80440-12-5

February 2012

When citing this report the following citation should be used:

National Disaster Management Guidelines- National Disaster Management Information and Communication System (NDMICS) 2011.

A publication of the National Disaster Management Authority, Government of India ISBN: 978-93-80440-12-5, February 2012, New Delhi

The National Guidelines are formulated under the Chairmanship of Shri B.Bhattacharjee, Hon'ble Member, NDMA in consultation with various specialists, experts and stakeholders in the subject field concerned from all across the country.

National Disaster Management Guidelines

National Disaster Management Information and Communication System



**National Disaster Management Authority
Government of India**

Vision

Building disaster resilience in the society through creation of a state-of-the-art knowledge-based National Disaster Management Information and Communication System (NDMICS) to provide GIS-based value-added information along with assured multiservices of audio, video and data to the various stakeholders for proactive and holistic management of disasters. Value added information along with data would be sent to the right people at the right time by establishing a reliable, dedicated and latest technology-based, National Disaster Communication Network (NDCN), with particular emphasis on last-mile connectivity to the affected community during all phases of disaster continuum.

Contents

<i>Foreword</i>		xv
<i>Acknowledgements</i>		xvii
<i>Abbreviations</i>		xix
<i>Executive summary</i>		xxv
1	Introduction	1
1.1	Introduction	1
1.2	Paradigm Shift in DM at Global Level	3
1.2.1	Initiatives on Natural Disaster Risk Reduction Programme	3
1.2.2	Global Initiative of Tampere Convention on Deployment of Telecommunication Resources for DM	4
1.3	Natural Hazard Profile in India and Special Features of ICT Systems	5
1.3.1	ICT for Flood Management : Special Features	5
1.3.2	ICT for Cyclone Management: Special Features	7
1.3.3	ICT for Earthquake Management: Special Features	7
1.3.4	ICT for Landslides Management: Special Features	8
1.4	Paradigm Shift in DM in India	8
2	Requirement of ICT Network During Various Phases of Disaster Continuum	11
2.1	Introduction	11
2.2	ICT for Mitigation Phase	11
2.3	ICT for Preparedness Phase	12
2.4	ICT for Response Phase	12
2.5	ICT for Recovery Phase	13
2.6	GIS platform Inevitable for Holistic DM	13
2.7	Action Points	14
3	Existing Communications Base and ICT Support-Situation Analysis	15
3.1	Introduction	15
3.2	Existing Telecommunication Network of Various Service Providers/ Government Agencies	16
3.2.1	National Emergency Communication Plan (NECP), Ministry of Home Affairs, Govt. of India	16
3.2.2	Disaster Management Support (DMS) Network of ISRO	17
3.2.3	Police Telecommunication Network (POLNET)	18

CONTENTS

3.2.4	National Informatics Centre (NICNET) Infrastructure	19
3.2.5	State Wide Area Network (SWAN)	21
3.2.5.1	Status of Implementation of SWAN	21
3.2.6	Railway Communication Network	22
3.2.7	BSNL Communication Network	24
3.2.8	Power Grid Corporation of India (PGCIL) Network	25
3.2.9	Network of Department of Atomic Energy (DAE)	26
3.2.10	Common Services Center (CSC) Scheme	26
3.2.11	The National Knowledge Network	27
3.2.12	Emergency Planning and Response System, Ministry of Environment & Forest (MoE&F)	28
3.3	Existing Hazard Forecasting and Warning Network	28
3.3.1	Cyclone Forecasting and Warning Network	28
3.3.2	Seismological Observations Network	28
3.3.3	Drought Warning Network	29
3.3.4	Flood Forecasting and Warning Network	29
3.3.5	Tsunami Warning Network	30
3.3.6	INSAT Based Distress Alert Transmitter for Fishing Boats	31
3.3.7	VHF Radio Communication System for Fishermen Community in Tamil Nadu	31
3.3.8	Decentralized DM Information Network, Jadavpur University	32
3.4	Communication Modes Available for Disaster Forecasting and Warning	32
3.5	Other ICT Based Initiatives (IRDN,NANADISK,NDEM)	35
3.6	Limitation in Existing Communication and ICT Support	36
3.6.1	NECP 2004 Plan	36
3.6.2	Emergency Operations Centres (EOCs)	37
3.6.3	Specific Disaster Related Issues	37
3.7	Limitations of Existing Application Development	37
3.8	Action Points	38
4	Need for GIS-Based National Disaster Management Information System	39
4.1	Introduction	39
4.2	Knowledge-Based Tools for Holistic DM	39
4.2.1	Development of Vulnerability Analysis and Risk Assessment Tools	40
4.2.2	Development of Decision Support System (DSS) in Virtual Environment	41
4.3	Rationale For Establishment of NDMIS	42
4.4.	Development of NDMIS	44
4.4.1	GIS-Database	44
4.5	Participatory Agencies and Nodes in NDMIS	45
4.6	Active Players of NDMIS	46
4.6.1	Clients	46

4.6.2	Data Providers	47
4.6.3	Data Validators	47
4.6.4	Information Creator	47
4.6.5	Security Managers	48
4.7	Approach to Establishment of NDMIS	49
4.8	Special Features for Design of NDMIS	49
4.8.1	Database and its Volume	49
4.8.2	Data Preparation and Validation	50
4.8.3	Documentation	50
4.8.4	Quality	50
4.8.5	Data Availability	51
4.8.5.1	Replication and Mirroring Management	51
4.8.6	Client Access	51
4.8.7	Interoperability	52
4.8.8	Performance and Scalability	52
4.8.8.1	Performance	52
4.8.8.2	Scalability	53
4.8.9	Application Services	53
4.8.10	Security and Protection of Data	54
4.8.10.1	Impact of Enhanced Security Levels on System Response	54
4.8.11	Data Protection	54
4.8.12	Action Points	55
5	Establishment of National Disaster Communication Network (NDCN)	56
5.1	Introduction	56
5.2	NDCN in a Nutshell	56
5.3	Approach for Establishment of NDCN	58
5.4	Special Features of NDCN	59
5.5	Operational Characteristics of NDCN	60
5.6	Technology Issues	61
5.6.1	Design Principles	62
5.6.2	Performance	62
5.6.3	Network Management Segment	62
5.6.4	Typical Bandwidth Requirements For The Network	62
5.7	Overall Architecture of NDCN	63
5.7.1	Connectivity from National to State HQs	63
5.7.2	Connectivity from State HQ to District HQs	63
5.7.3	Connectivity from District HQs to Sub-Divisions/Blocks	63
5.7.4	Last Mile Connectivity & Communication Build-up at Disaster Site	64
5.7.5	Last Mile Connectivity (LMC) for the Disaster Site.	64
5.7.6	Last Mile Connectivity (LMC) beyond Blocks/Talukas to Villages	64

CONTENTS

5.8	Forecasting and Early Warning	65
5.8.1	Advance Forecasting of Hydrometeorological Hazards for DM	65
5.9	Action Points	66
6	Emergency Operations Centres: Connectivity, Database & Applications Development	67
6.1	Introduction	67
6.2	Flow of Information for EOCs at Different Levels	68
6.2.1	For Command and Control	68
6.2.2	For Interaction, Coordination & Execution	68
6.3	Vertical & Horizontal Connectivity of NDCN	69
6.4	Detailed Design of the Core Network	70
6.5	Functional Role of NEOC of NDMA	70
6.6	Stakeholders of NEOC, NDMA	71
6.7	Applications and Database Required at NEOC	72
6.7.1	Application Requirement	72
6.7.2	Objectives of Application Development	73
6.7.3	Approach to Application Development	73
6.7.4	Disaster Recovery (DR) Site for NEOC	75
6.7.5	Database Requirements at National EOC	75
6.8	Applications and Database at the State EOCs	76
6.8.1	Applications at State EOCs	77
6.8.2	Database at State EOCs	77
6.8.3	Stakeholders of State EOCs	77
6.9	Applications and Database at the District EOCs	78
6.9.1	Applications at District EOCs	78
6.9.2	Database at District EOCs	78
6.9.3	Stakeholders of District EOCs	79
6.10	Action Points	79
7	Facilities Provided at EOCs	80
7.1	Generic Requirements at EOCs	80
7.2	Facilities at NEOC and SEOCs	81
7.3	Facility at Operational Control Room (OPS) at NDMA/MHA	82
7.4	Facilities at DEOCs	82
7.5	For Incident Commander at Affected Site	82
7.5.1	ICT Needs at Incident Command System (ICS)	82
7.5.2	Mini Mobile Communication Pack (MMCP) at the Districts Headquarters	83
7.6	At NDRF Headquarters (Base Camp)	83
7.6.1	Facilities at Mobile Emergency Operations Centers (MEOCs)	84

7.7	At Tactical Headquarters of NDRF Commander	84
7.7.1	For Companies/Teams/Sub-Teams (Distribution Shown in Annexure 17)	84
7.8	Action Points	85
8	Technological Challenges for Implementation of NDCN	86
8.1	Introduction	86
8.2	Innovative Approach to Remove Existing Gap	86
8.3	Restoration of Full Bandwidth Available	87
8.4	Language Barrier	87
8.5	Creation of Call Centres and Websites (Multi-lingual)	87
8.6	Requirements of NDMIS	87
8.7	Communication Build-up in Graded Manner	88
8.8	Logistic Support and Maintenance of NDCN	88
8.9	Action Points	89
9	Technology, Emerging Trends and R&D Requirements	90
9.1	Introduction	90
9.2	Multiplexing and Modulation Techniques for Increased Traffic Carrying Capacity	90
9.3	Convergence of Voice, Video and Data Services	91
9.4	Telecommunication Network Technologies	91
9.4.1	Satellite Communication Network	91
9.4.1.1	Single Channel Per Carrier (SCPC)	94
9.4.1.2	Very Small Aperture Terminal (VSAT)	94
9.4.1.3	Satellite Phones	95
9.4.1.4	INSAT MSS Type- D System	96
9.4.2	DTH (Direct-To-Home)	96
9.4.3	Optical Fiber Communication (OFC) Networks	97
9.4.3.1	Propagation Modes Through Optical Fibers	97
9.4.3.2	Dense Wave Division Multiplex (DWDM)	98
9.4.4	Signal Transmission and Mobile Communication Technologies for Cellular Service	98
9.4.4.1	Mobile Communication	101
9.4.4.2	Global System for Mobile (GSM)	102
9.4.4.3	Code-Division Multiple Access (CDMA)	104
9.4.4.4	Comparison of the GSM and CDMA Technologies used for Cellular Services	104
9.4.4.5	Future Trends	106
9.4.5	Wi-Fi Technology	107
9.4.6	WiMAX (Worldwide Interoperability of Microwave Access) Technology	108
9.4.7	Public Mobile Radio Trunking System (PMRTS)	108

CONTENTS

9.4.8	VHF Radios	110
9.4.9	Portable AM/FM Broadcasting Radio Station	110
9.5	Emerging Scenario	111
9.5.1	Orthogonal Frequency Division Multiplex (OFDM)	111
9.5.2	IP Multimedia Subsystem (IMS)	112
9.5.3	RF Identification Systems (RFID)	113
9.5.4	Telepresence	113
9.5.5	Advanced Technology for Detection and Tracking of Trapped People	113
9.5.6	Multiple Input Multiple Output (MIMO) (Wireless Technology	114
9.5.7	Terminal Devices	114
9.5.8	Software Defined Radio (SDR) and Cognitive Radio (CR) for Spectrum Sharing (SpS) and Flexible Spectrum Usage (FSU)	114
9.5.8.1	Spectrum Sharing and Flexible Spectrum Usage	114
9.5.8.2	Software Defined Radio (SDR)	115
9.5.8.3	Cognitive Radio	116
9.5.9	High Altitude Platform Stations (HAPS)	117
9.5.10	Unified Messaging System	118
9.5.11	IPV6	118
9.5.12	Next Generation Network (NGN)	119
9.5.13	Multi Service Transport (MSTP)	120
9.5.14	Satellite Phones	120
9.6	R&D Efforts	120
9.7	Action Points	122
10	Last Mile Connectivity	123
10.1	Introduction	123
10.2	Providing Need Based Communication Support	124
10.2.1	Phase-I : Emergency Restoration of Communication Link (within fifteen minutes after reaching the site)	124
10.2.2	Phase-II :Establishment of Communication Link with Added Bandwidth through MEOC by NDRF Battalion	125
10.2.3	Phase-III : Operational Requirement with Full Restoration of Bandwidth	126
10.2.4	Incident Commander	126
10.3	Suggested Actions at State/UT level	126
10.3.1	Utilisation of Traditional Communication System	126
10.3.2	Communication for Fishermen Community	127
10.3.3	Public Mobile Radio Network	127
10.3.4	Cyclone Resilient Mobile Towers	127
10.3.5	WiMAX Technology	128
10.3.6	Communication Platform for Protection from Floods	128

10.3.7	Multi-Task Riverine Ship for Disaster Management: Specific to Assam/West Bengal	128
11	Implementation of NDCN	129
11.1	Introduction	129
11.2	Planning and Execution of The Network (by Implementing Agency)	129
11.3	Operational Support (by SDMA/NDMA)	129
11.4	Training of Manpower for Operations (by NDMA/SDMA)	129
11.5	Network Maintenance of NDCN (by Implementing Agency For 5 Years)	130
11.6	Funding Mechanism	130
11.7	Licenses and Clearances	130
11.8	Action Points	131
12	Summary of Action Points	132
12.1	Introduction	132
12.2	Action Points at NDMA	132
12.2.1	Planning	132
12.2.2	Implementation of NDCN	133
12.2.3	Implementation of Data Fusion Centre (NDMIS) on GIS Platform	133
12.3	Action Points for Implementing Agency	133
12.4	Action Points for State Governments	134
12.4.1	Other Recommended Action Points	135
	Appendices	
I	Paradigm Shift in Global Approach to DM	136
II	Five levels of Security for NDMICS	138
III	Telecommunication System: Technology Aspects	140
IV	Open System Interconnection (OSI) Reference Model for Network Architecture	143
V	Convergence Technologies (for Voice, Video & Data)	145
VI	National Allocation of Spectrum	150
VII	Evolution of Mobile Telephony	152
VIII	Terrestrial Trunked Radio (TETRA)	154
	Annexures	
1	Disaster Management Continuum	158
2	Major Disasters In India: 1990-2005	159
3	Major Disasters: 1980-2008	160
4	Flood Hazard Map of India	161
5	Cyclone and Wind Hazard Map of India	162
6	Earthquake Hazard Map of India	163

CONTENTS

6A	Landslide Hazard Zonation Map of India	164
7	National Disaster Management Structure	165
8	NDRF Battalions- Locations	166
9	List of Early Warning & Forecasting Agencies Requiring Due Connectivity	167
10	Converged & Integrated Communication Connectivity	168
11	Communication & IT Support Plan	169
12	Information Access	170
13	Information Flow: Emergency Operation Center (EOC)	171
14	Mobile Emergency Operation Center (MEOC)	172
15	Communication Equipments for NDRF at Disaster site	173
16	MEOC Communication	174
17	NDRF Requirement at Site per Battallion	175
	Core Group Members	177
	Contact Us	180



Vice Chairman
National Disaster Management Authority
Government of India

FOREWORD

The formulation of National Guidelines on various disasters and cross-cutting issues is an important part of the mandate given to the National Disaster Management Authority (NDMA), on the basis of which plans will be prepared by various Ministries at the Centre and the States.

The National Guidelines on National Disaster Management Information and Communication System (NDMICS) have been formulated after wide consultations with all the stakeholders and all technical and operational issues have been incorporated. This would provide assured multi-services of audio, video and data augmented with GIS-based value-added information to the various stakeholders. This would also facilitate proactive and holistic management of disasters. Services of domain experts from IT, space based technologies and vulnerability analysis and risk assessment would be inducted to generate the proposed value added information.

The guidelines also envisage establishing a reliable, dedicated and technology-based, National Disaster Communication Network (NDCN) for transporting the value added information to the stakeholders, with particular emphasis on the last mile connectivity to the affected community during all phases of disaster continuum. The proposed NDCN would be a “network of networks” created by leveraging all existing terrestrial and satellite communication networks including NICNET, SWANs, POLNET, DMNET (ISRO) etc that would be connected to various Emergency Operation Centers (EOCs) at National (NEOC), State (SEOCs) and Districts (DEOCs) Levels through appropriate routers and gateways.

The fail-safe character of NDCN, built with adequate redundancy and diversity, would be assured through an additional satellite based communication link from NEOC to the last mile at disaster site. Similarly, the dedicated bandwidth required for disaster management at various levels of administration would be guaranteed through Service Level Agreements (SLAs) with various operators. Further to ensure last-mile connectivity, a mobile communication package at the district collector level and a transportable communication van at the NDRF level will be

provided by NDMA to establish graded communication capability at the disaster site. Continuous monitoring for compliance to assure bandwidth from the operators would be carried out through Network Management System (NMS) located at NEOC.

I am indeed extremely happy to acknowledge the meticulous work and immense personal contribution of my colleague, Shri B. Bhattacharjee and also his ability for efficient coordination with the Members of the Core Group as well as the other Stakeholders in the country during the entire process of preparing these National Guidelines. I also express my gratitude for the sincere and professional inputs from the members of the Core Group of experts in assisting the NDMA in the formulation of these Guidelines.

I am certain that these Guidelines, when implemented, will help in providing a reliable and dedicated communication network that would carry knowledge based information at the right time to the right people for handling disaster management in a holistic fashion.

New Delhi
August 2011



(M. Shasidhar Reddy)



Member
National Disaster Management Authority
Government of India

ACKNOWLEDGMENTS

At the outset, I must express my sincere thanks to all the Members of the Core Group for their invaluable contribution and whole-hearted cooperation to assist NDMA in preparing the National Disaster Management Guidelines: National Disaster Management Information and Communication System (NDMICS). But for active participation as well as high standard of the technical inputs from the Members of the Core Group, it would have not been possible to bring out these National Guidelines much needed for holistic management of disasters.

To move away from erstwhile reactive and response centric approach for disaster management to a proactive and technology-driven holistic one, these Guidelines envisage induction of experts from S&T community in the country in general and those from computer science and space-based technologies in particular, to establish a state-of-the-art National Disaster Management Information System (NDMIS) on GIS – Platform at the national level. There would enable the stakeholders at various level of administration for carrying out vulnerability analysis and risk assessment work for the people, the property and the environment for decision on mitigation projects to be undertaken with pre-event scenario or to build better in the post-event scenario. It would also enable generation of decision support system for most efficient and effective rescue and relief operations during the disaster Scenario.

I must place on record my gratitude and appreciation for the guidance and constructive suggestions received from Telecommunication Engineering Centre and Wireless Planning Coordination wing of DoT, National Informatics Center and Indian Space Research organization to improve the quality of these guidelines. Valuable feed backs received from various State governments in formulating the Guidelines are also being thankfully acknowledged.

Special mention must be made of the sustained efforts and technical inputs received from our communication specialists, viz Maj Gen Subhash Chander (Retd) in the initial stage followed by Shri P. Ganesh during the later stage, for bringing the document to its final shape

with incorporation of the various comments/suggestions received from various stakeholders from time to time. Efforts of Dr.M.C.Abani, Senior Specialist (Nuclear) in detailed scrutiny and preparation of the document in the standard format are thankfully acknowledged.

I am also happy to acknowledge the support and co-operation extended by the entire administration of NDMA in general and that of Shri A.B. Prasad, former Secretary, NDMA and Dr. Noor Mohammad, Secretary, NDMA in particular. In this context, I would like to put on record my sincere appreciation of the full cooperation and the tireless efforts of all the members of my Secretariat, starting from Shri Rajni Kant, Shri Ashok Kumar Balgahre, Ms Harshita Chauhan, Shri Hari Kumar P K, Shri Tushar Sharma and Ms Renu Punia during the entire period of preparing this document.

Finally I would like to express my gratitude to our former Vice Chairman, Gen N. C. Vij, PVSM, UYSM, AVSM (Retd) and our present Vice Chairman, Shri M. Shashidhar Reddy for their critical review, guidance and additional inputs that have immensely added value to the content as well as to the quality of these National Guidelines. My gratitude and sincere thanks are also to all the distinguished Members of NDMA, both former as well as present, for their valuable feedbacks from time to time for bringing this National Document to its final shape.

It is sincerely hoped that these National Guidelines, when implemented by the various stakeholders at different level of administration, would enable to establish a reliable and dedicated NDMICS that would contribute significantly in achieving NDMA's vision to build disaster resilient India.



B.Bhattacharjee

New Delhi
August 2011

Abbreviations

ACWC	Area Cyclone Warning Center
ADPC	Asian Disaster Preparedness Center
ADSI	Analog Display Services Interface
AM	Amplitude Modulation
AMPS	Advanced Mobile Phone System
APCO	Association of Public safety Communications Officers
BSC	Base Station Controller
BSS	Base Station Subsystem
BTS	Base Transceiver Station
CCK	Complementary Code Keying
CDMA	Code Division Multiple Access
CDR	Cyclone Detection Radar
CR	Cognitive Radio
CSC	Common Services Center
CTI	Computer and Telephony Integration
CUG	Closed User Group
CWC	Central Water Commission
CWDS	Cyclone Warning Dissemination System
DAC	Digital to Analogue Converter
DAE	Department of Atomic Energy
DAMA	Demand Assigned Multiple Access
DAT	Distress Alert Transmitter
DBS	Direct Broadcast Satellite
DC	District Collector
DEN	Dispatch Enhanced Network
DEOC	District Emergency Operations Centre
DGNA	Dynamic Group Number Assignment
DHQ	District Headquarter
DIT	Department of Information Technology
DM	Disaster Management
DMIS	Disaster Management Information System

ABBREVIATIONS

DMO	Direct Mode Operation
DMS	Disaster Management Service
DOS	Department of Space
DR	Disaster Recovery
DRM	Disaster Risk Management
DSC	Decision Support Centre
DSPT	Digital Satellite Phone Terminal
DSS	Decision Support System
DTH	Direct-To-Home
DWDM	Dense Wave Division Multiplexing
EDGE	Enhanced Data rates for GSM Evolution
EIC	Emergency Information Centre
EOC	Emergency Operations Center
ERS	Emergency Restoration System
EV-DO	EVolution Data Optimised
EVDV	EVolution Data Voice
EW	Early Warning
FDMA	Frequency Division Multiple Access
FIFO	First In First Out
FM	Frequency Modulation
FMS	Facility Management Services
FOIS	Freight Operations Information System
FSU	Flexible Spectrum Usage
FTP	File Transfer Protocol
G2C	Government to Center
G2G	Government-to-Government
GIS	Geographic Information System
GOI	Government of India
GoS	Grade of Service
GPRS	General Packet Radio Service
GPS	Global Positioning System
GSM	Global System for Mobile
GSN	Global Seismographic Network
HAPS	High Altitude Platform Station

HEOS	Highly Elliptical Orbit Satellite
HF	High Frequency
HLR	Home Location Register
HSDPA	High Speed Downlink Packet Access
HSPA	High Speed Packet Access
HTTP	Hypertext Transfer Protocol
ICET	Intergovernmental Conference on Emergency Telecommunication
ICS	Incident Command System
ICT	Information & Communication Technology
IDRN	Indian Disaster Resource Network
IEEE	Institution Electrical and Electronics Engineers
IETF	Internet Engineering Task Force
IMD	India Meteorological Department
IMS	IP Multimedia Subsystem
IMSI	International Mobile Subscriber Identity
IMT	International Mobile Telecommunications
INCOIS	Indian National Centre for Ocean Information Service
IP	Internet Protocol
IRS	Indian Remote Sensing
ISDN	Integrated Services Digital Network
ISRO	Indian Space Research Organization
ITU	International Telecommunication Union
LEO	Low Earth Orbit
LEOS	Low Earth Orbit Satellite
LER	Label Edge Router
LMC	Last Mile Connectivity
LOS	Line Of Sight
LSP	Label Switched Path
LSR	Label Switching Router
LTE	Long Term Evolution
MCAP	Mobile Communication Access Platform
MEO	Medium Earth Orbit
MEOC	Mobile Emergency Operations Centre
MEOS	Medium Earth Orbit Satellite

ABBREVIATIONS

MGC	Media Gateway Controller
MHA	Ministry of Home Affairs
MIMO	Multiple Input Multiple Output
MLLN	Managed Leased Line Network
MMCP	Mini Mobile Communication Pack
MOES	Ministry of Earth Sciences
MOU	Memorandum of Understanding
MPLS	Multi Protocol Label Switching
MPS	Mobile Positioning System
MPT	Ministry of Post and Telecommunication
MSC	Mobile Switching centre
MSP	Multi Service Platforms
MSS	Mobile Satellite Service
MSTP	Multi Service Transport Protocol
MZ	Militarized Zone
NADAMS	National Agricultural Drought Assessment and Management System
NAT	Network Address Translation
NCMC	National Crisis Management Committee
NDCN	National Disaster Communication Network
NDEM	National Database for Emergency Management
NDKN	National Disaster Knowledge Network
NDMIS	National Disaster Management Information System
NDMICS	National Disaster Management Information and Communication System
NDRF	National Disaster Response Force
NECP	National Emergency Communication Plan
NEOC	National Emergency Operations Center
NGN	Next Generation Network
NIC	National Informatics Centre
NICNET	National Informatics Center Network
NIOT	National Institute of Ocean Technology
NKN	National Knowledge Network
NMS	Network Management System
NMT	Nordic Mobile Telephone
NRSC	National Remote Sensing Centre

OFDM	Orthogonal Frequency Division Multiplex
OPGW	Optical Ground Wire
OSI	Open System Interconnection
PCM	Pulse Code Modulation
PDC	Personal Digital Cellular
PDO	Packet Data Optimised
PM	Phase Modulation
PMG	Project Management Group
PMR	Public Mobile Radio
PMRTS	Public Mobile Radio Trunking System
POP	Points of Presence
POTS	Plain Old Telephone System
PPDR	Public Protection and Disaster Relief
PSK	Phase Shift Keying
PSTN	Public Switched Telephone Network
PTWC	Pacific Tsunami Warning Centre
QoS	Quality of Service
QPSK	Quadrature Phase Shift Keying
RDBMS	Relational Database Management System
RFID	Radio Frequency Identification
RMC	Regional Meteorological Centre
RoW	Right of Way
RS & GIS	Remote Sensing & Geographic Information System
RTWC	Regional Tsunami Warning Centre
S&T	Science & Technology
SAC	Space Applications Centre
SCA	Service Centre Agency
SDA	State Designated Agency
SDH	Synchronous Digital Hierarchy
SDR	Software Defined Radio
SDSS	Spatial Decision Support System
SEOC	State Emergency Operations Center
SHQ	State Headquarter
SIM	Subscriber Identity Module

ABBREVIATIONS

SLA	Service Level Agreement
SMS	Short Messaging Service
SMTP	Simple Mail Transfer Protocol
SRC	State Relief Commissioner
STM	Synchronous Transport Module
SWAN	State Wide Area Network
TACS	Total Access Communication System
TCP	Transmission Control Protocol
TDM	Time Division Multiplexing
TDMA	Time Division Multiple Access
TEC	Telecommunication Engineering Centre
TMSI	Temporary Mobile Subscriber Identity
UDP	User Datagram Protocol
UHF	Ultra High Frequency
UNDP	United Nations Development Program
USOF	Universal Service Obligation Fund
V+D	Voice Plus Data
VA&RA	Vulnerability Analysis & Risk Assessment
VC	Video-Conferencing
VHF	Very High Frequency
VLR	Visitor Location Register
VOIP	Voice Over Internet Protocol
VPN	Virtual Private Network
VSAT	Very Small Aperture Terminal
WCDMA	Wideband CDMA
WLAN	Wireless Local Area Network
WPC	Wireless Planning and Coordination

Executive Summary

Background

Since its earliest days, communication has played an important role in Disaster Management (DM) in providing information to all the stakeholders in Disaster Management, particularly in emergency rescue and relief operations for the disaster affected people. Perhaps, no more graphic example can be found than in the events surrounding the sinking of the "Titanic" on April 14th, 1912, when radio communication technology was instrumental in soliciting aid from the nearby vessels "California" and "Carpathia" which were able to proceed to the rescue of the people.

Natural Disasters cannot be prevented at the present level of Science & Technology (S&T) and community may have to live with certain level of risk – the level of risk depending on the level of S&T available for induction in DM and the resources made available by the Government for its actual induction, for holistic management of disaster in a proactive way. Holistic management of disaster calls for assigning priority in the prevention, mitigation & preparedness activities in the pre-disaster scenario of the DM continuum, while strengthening the efforts for faster and more efficient response through properly trained personnel equipped with advanced equipment/instruments and building better recovery during rehabilitation and reconstruction period.

Based on this realization, there has been a paradigm shift in approach to DM world over from erstwhile reactive and response centric to

a proactive and holistic one. Starting with the UN General Assembly meeting on 11th December, 1987, same sentiments have been echoed in the world conferences on natural disaster reduction-first at Yokohama in 1994 and then at Hyogo, Kobe in 2005. It has now been recognized that disaster prevention, mitigation, preparedness and relief are the four elements along with environmental protection that are closely interrelated with sustainable development. For sustainable development, nations should, therefore mainstream them in their development plans and ensure efficient follow-up measures at all the levels of administration for their effective implementation. In the context of communication system needed for DM work, at the Intergovernmental Conference on Emergency Telecommunications (ICET-98) at Tampere, Finland, held on 18 June, 1998, a legally binding international treaty on employment of Telecommunication Resources was unanimously adopted by 75 countries and it was recognized, that the timely deployment of effective telecommunication resources for rapid, efficient, accurate and truthful information flows are essential for reducing loss of life, human suffering and damage to property and to the environment caused by natural disasters. India became signatory to this Tampere Convention on 29th November, 1999

Timely deployment and use of telecommunication resources play a crucial role in saving life, disaster mitigation and relief operations. The participating parties were

therefore, concerned about the possible impact of disasters on communication facilities and information flows and, affirmed the extreme importance to establish telecommunication resources at the national level and cooperation amongst various member States and non-state entities to facilitate the use of the same.

Keeping in mind the hazard profile of the country and its impact on the national economy at regular intervals in general and the impact of the last few major disasters, in particular, viz: Orissa Super cyclone, Bhuj Earthquake, Tsunami and J&K Earthquake, India decided to switch over from erstwhile reactive and response centric to a proactive and holistic management of DM by inducting science and technology in all the elements of DM continuum and unanimously passed DM act on 23rd Dec, 2005 in the Parliament. Broadly, this approach calls for development of the essential scientific and technological infrastructures and establishment of an advanced technology based reliable and dedicated communication network, which would play a decisive role.

Revolutionary technology advances in the areas of communication, remote sensing, modeling and simulation capabilities as well as spectacular growth in IT offering computational capacity at affordable cost and software tools and techniques for data viewing and visualization have led to a paradigm shift in disaster management information system. Such information system assigns priority in development of ICT support for the management of pre-disaster events, while improving the efforts of ICT backup for the post disaster scenarios through systematic induction of advanced science & technology.

Genesis of National Disaster Management Guidelines: National Disaster Management Information and Communication System (NDMICS)

The holistic management of disaster calls for establishment of an all encompassing, integrated, multi-lateral, reliable, responsive and dedicated 'State of the Art' Digital Information and Communication Support Infrastructure known as National Disaster Management Information and Communication System (NDMICS) essential for various phases of DM. The major components of NDMICS are: i) National Disaster Communication Network (NDCN) for providing telecommunication backbone, which would be utilized for disseminating value added information; and ii) Information on GIS platform in the form of Vulnerability Analysis and Risk Assessment (VA&RA) and by a Decision Support System (DSS), in addition to the normally required, voice, video and data transmission.

A Core Group consisting of Members drawn from the pool of experts from various Government Departments such as TEC, WPC, ISRO, NIC, State Police, was constituted to discuss and deliberate over various aspects of telecommunication & IT with regard to the creation of NDMICS. The Core Group held several meetings spanning over a period of about one and half years through constitution of several sub-groups to deal with the various specific issues in a focused manner. After meaningful deliberations, the NDMICS Guidelines document has been prepared.

The Guidelines on NDMICS recommend building a nationwide "network of networks"

created by leveraging all existing terrestrial communication and satellite networks, including NICNET, SWANs, POLNET, DMNET (ISRO) etc and connecting them to various Emergency Operation Centers (EOCs) at National (NEOC), State (SEOCs) and District (DEOCs) Levels for assured bandwidth in all phases of DM. Since the terrestrial communication network is quite likely to be affected during disasters, disrupting the communication connectivity (which is the most crucial for response and relief work), NDCN will establish separate satellite network of NDMA which will link NEOC, SEOCs, DEOCs and Mobile EOCs through VSAT Network/INMARSAT phones for providing fail-safe communication during disaster scenarios. Disaster Recovery (DR) site for NEOC has also been planned in a geographically distant place viz National Remote Sensing Center (NRSC), Hyderabad (which is also less vulnerable to natural hazards).

The National Guidelines have been structured into 12 chapters with Appendices I to VIII and Annexures 1 to 17.

Highlights of the National Guidelines Document

The Guidelines have been prepared with a view to provide the necessary guiding principles to the central ministries/departments and the state governments for establishing a communication network to meet the requirements of dedicated disaster communication.

Highlights of Chapter 1 to 11 are presented below and Chapter 12 provides the summary of action points arising out of the first 11 chapters. There are 8 Appendices included to give the detailed technical information on various

technical issues referred to in the document. Sketches/Diagrammatic information are placed in the Annexures towards the end of the Guidelines document.

Highlights of Chapter -1: Introduction

This chapter introduces the subject of Disaster Management (DM), highlighting the prevailing global scenario as well as the scenario in India. It brings out the need for the changes in disaster management approach from reactive and response centric to proactive and holistic one, for sustainability of development work in the nation, including the global initiative of Tampere Convention for deployment of all available Telecommunication Resources in the nation for disaster management. Following the global trend, the paradigm shift in disaster management in India towards holistic management has also been briefed. As a major step, Indian Government has taken several initiatives by placing DM activities in the country with necessary institutional and legal support for which Disaster Management Act was unanimously passed in the Parliament in December, 2005, leading to the formation of NDMA as the apex body at the national level (with Prime Minister as Chairman) along with SDMAs at the state level (with respective Chief Ministers as the Chairpersons) and DDMAAs at the district level (with respective District Collector/Magistrate as the Chairperson with elected representative from Panchayati Raj Institutes co-opted as the Vice-Chairman). Also, in this chapter, is a brief description of the four most crucial facets of natural hazards in disaster viz floods, cyclones, earthquakes and landslides with their respective profile with country and the

special features of ICT required for management of these hazards.

Highlights of Chapter -2: Requirement of ICT network during various phases of Disaster Continuum

This chapter analyses the requirement of ICT network during various phases of disaster continuum, which are different for each phase of disaster management viz mitigation, preparedness, response, and recovery.

Mitigation Phase

The activities in the mitigation phase are not time critical. However, the networking requirements to support this phase should meet key attributes, like the need to move large volume of data/information, broad connectivity among a diverse group of organizations etc. The data are largely archive-based, and hence several cataloged and linked repositories are to be accessed through good search engines.

Preparedness Phase

Distribution of warning data through a dedicated network is the prime requirement and timeliness becomes a critical factor for some types of information dissemination. Although disaster prediction accuracy and warning lead-times are improving, cyclone and earthquake alerts still require wide distribution in minutes or seconds.

Response Phase

The primary requirement in this phase is to establish communication among response teams and with the general public for achieving speedy response to disaster events and hence

this activity is time critical. The major challenge is to establish reliable and easily configurable communication (which is vital for efficient disaster response operations) in a short time under extreme conditions of disruption in the infrastructure system.

Recovery Phase

Timeliness concerns are relaxed in this phase but the quantum of work is huge in the recovery phase. Bulk of the data needs during recovery include significant onsite data collection related to reconstruction, claims processing, and documentation of lessons learnt. The Internet is an ideal communication link for such transfers.

Relevance of GIS platform for the entire domain of DM

GIS can provide a valuable support during various phases. During the preparedness and response phases, GIS can support better response planning for determining evacuation routes or locating critical infrastructure and vital lifelines, etc. Based on the information provided by GIS, it is also possible to estimate what quantity of food supplies, bed space, clothes, medicine, location of fire stations and paramedical will be required at each shelter based on the number of expected evacuees. Similarly, GIS facilitates online monitoring of the status of ongoing work in the recovery phase.

Thus, planned infrastructure for disaster information dissemination should offer an appropriate mix of communication technologies to respond to diverse requirements. The Internet is suitable ICT support to the recovery and mitigation phases, but urgent and life-critical

communications during the preparation and response phases call for systems that are more robust. The need for establishing a National Disaster Communication Network (NDCN) is thus essential to meet the ICT requirement for assured response by the right people without failure.

Highlights of Chapter -3: Existing Communication Support and Situation Analysis.

This chapter primarily covers the brief details of existing telecommunication infrastructure of various service providers, hazard forecasting and warning networks along with certain limitations in the existing network vis a vis the DM requirement. Since there has been rapid deployment of optical fiber based telecommunication infrastructure by different service providers (both private and PSUs), large bandwidth pipes are available across the country. Bandwidth from these service providers can be leased out for building NDCN. Also, the State Wide Area Network (SWAN), which is the approved scheme of GoI for interconnecting State headquarters, District headquarters and Block headquarters with a minimum of 2 mbps leased lines for supporting various e-Governance initiatives, can be effectively utilized as part of NDCN. Further, NDCN can also be connected to the extensive Satellite Networks such as Police Telecommunication Network (POLNET), National Information Center Network (NICNET) and Disaster Management Support (DMS) Network of Indian Space Research organization (ISRO) already existing in the country. Ministry of Home Affairs has conceived National Emergency

Communication Plan (NECP) in 2004 for disaster management, which is primarily a satellite based network utilizing POLNET, NICNET and DMS network. This plan is under implementation to provide communication facilities to NDRF battalions for handling the disaster situations.

Existing Hazard Forecasting and Warning Network

There are different networks set up viz; Cyclone Forecasting and Warning Network and Seismological Observation Network by IMD, Drought Warning Network by DOS, Flood Forecasting and Warning network by CWC, Tsunami Warning Network for RTWC (Regional Tsunami Warning Center) by INCOIS etc. Various communication modes such as radio and television, fixed and mobile telephones, Short Message Service, internet, community radio etc are available for disseminating such warnings. A number of agencies like All India Radio, Doordarshan, HAM radio etc provide facilities for Early Warning system for communicating alert messages.

Limitations of Existing Communication System for DM Work

Most prevalent POLNET operates in C-band (that calls for large antenna), whereas, highly compact and portable satellite terminals are available in Ku-band. It is voice-centric with limited data handling capability, whereas, the needs for DM handling stakeholders are voice, video and data with adequate bandwidth. Number of communications and IT networks are operating at the National and State level in a standalone mode and there is need to connect them together for redundancy and interoperability. No effective Data Fusion centre

has been established. Data Fusion at National Level along with GIS based applications is of paramount importance.

Interactive relationship is required throughout the application deployment lifecycle. The present application deployment is lacking this aspect as, it is mostly driven by software professionals and the involvement of the end user is only during crisis situations.

Highlights of Chapter-4 : Need for GIS-based NDMIS (National Disaster Management Information System)

To move away from response centric to holistic approach of DM, there is an immediate need to create NDMIS at NDMA to provide the necessary knowledge-based information much needed for faster and effective DM instead of relying only on voice, data or video. NDMIS refers to the hardware and software distributed over the country that are used for collection, storage, retrieval, mapping and analysis of geographic, demographic, topographic, infrastructure details, socio-economic data etc., that have been superimposed on digitized base-map (prepared at the appropriate scales with required contour intervals) and the hazard profile data in conjunction with satellite imageries to generate knowledge-based information (i) like VA&RA tool, computerised virtual environment for their utilization in the pre-event scenarios, and (ii) Decision Support System (DSS), that are most effective empowering tools for during-and post-event scenarios.

Using information on GIS-platform, it is easy to visually observe the critical information

on location, progression and / or regression of the disaster with the peace time and prepare appropriate action plans for post-disaster scenario of response efforts, that can be transmitted to various stakeholders (viz incident commanders at EOC's as well as the disaster response personnel) for quick and effective implementation with excellent coordination. GIS can support better planning for response in terms of evacuation routes, location of vital lifelines (like locations of fire stations, medical/paramedical units etc), relief materials, shelters, airports, railways and ports, etc.

Rationale for the establishment of NDMIS

VA&RA tool : The single most important scientific tool that needs to be deployed for pre-event scenario is the "Vulnerability Analysis and Risk Assessment" (VA&RA) of the people, the habitats and the infrastructures in different parts of the country with respect to various natural hazards for empowering the stakeholders at all levels of administration. The powerful VA&RA tool, would enable DM - Stakeholders to avoid adhoc decisions by way of identifying and prioritizing (as per Vulnerability Profile) of actions like adaptation of appropriate technologies for mitigation programme including retro-fitting of life-line and heritage buildings, major schools and other important community structures.

Decision Support System (DSS) and Virtual Environment : Like VA&RA tool for pre-event scenario, there are a host of other equally important DSS tools (needed during-and post-event scenarios) and computer based Virtual Environment, that are effective tool for testing the preparedness programme.

Individual images or elements

of information often become much more meaningful and empowering when carefully combined with complementary data. The fusion of various disparate data can provide the disaster managers with value added decisions by way of a dynamic Mapping system (superimposed on GIS Platform) that are most meaningful and effective tool for DM.

Timely information in the form of location, progression and regression of disasters during various phases of the disaster, depicted in a dynamic map is essential towards effective management of the disasters. Such information can be generated in Geographic Information System (GIS) linked with Global Positioning System (GPS) by integrating the real-time space-based imageries of the hazards with the corresponding ground information. GIS-platform allows easy visualization of the dynamics of the disaster with respect to time and preparation of appropriate action plans for rescue and relief operation as well as post-disaster scenarios that can be transmitted to various stakeholders (viz Incident Commander, Emergency Operations Centers (EOCs) as well as the disaster response personnel) for quick and efficient implementation with excellent coordination

Presently some of the knowledge-base is available in the nation in some public and private archives that are best suited to its own disaster management. However, the value for organizing the virtual knowledge base to benefit all the stakeholders working in all phases provides the necessity to integrate all the available information and or create information for all phases of disaster management.

This is the rationale to develop NDMIS at

NDMA, where the disaster data collected from different nodal agencies will be utilized along with detailed Geographic Information System (GIS), for generation of very sophisticated and actionable information for all the stakeholders at various levels of administration by involving the domain experts from the S&T community of the nation. Further details of NDMIS are included in chapter 5.

Highlights of Chapter - 5 : Establishment of National Disaster Communication Network (NDCN)

The basic concept revolves around creation of a network of networks utilizing the existing National, State and District level Communication Infrastructure to the maximum possible extent. This network would be a dedicated (w.r.t bandwidth availability), reliable, multi-layered, inter-operable network with adequate redundancy and diversity for converged (Voice, Data & Video) services spread over the nation with a distributed architecture. The Network will be hosted on the existing terrestrial backbone (optical fiber/microwave) with added satellite media as its backup to ensure fail-safe character and the last mile connectivity would be based on satellite and VHF links with evolution towards Wi Fi systems/ WiMax/ micro-cellular. The NDCN network comprises of vertical and horizontal connectivity. The vertical connectivity consists of Emergency Operations Centers across national, state, district and incident area levels. The horizontal connectivity consists of connectivity with various stakeholders, who need connectivity to NDCN for effective Disaster Management (DM).

Creation of NDCN Communication and IT assets would require appropriate Static and Mobile EOCs (based on workstation), for effective DM. At each of the functional levels, the plan is to establish EOCs with requisite workspace along with Communication and IT connectivity and administrative support facilities for control, coordination and management of disasters. While at National, State and District levels including the locations of NDRF battalions it would be in the form of Static EOCs, MEOCs would be mobile and vehicle based for control of live disaster site by NDRF battalions.

The existing NEOC-I at MHA and the proposed NEOC-2 of NDMA would be mirror image to each other by appropriate up gradation of the existing NEOC-1. The Disaster Recovery (DR) Center is proposed to be in NRSC Hyderabad. Network engineering will be done to undertake Data Warehousing & Data Mining of information collected from Satellite pictures, climatic conditions, Meteorological data & other precursors of impending disasters.

A GIS-based Data Fusion Centre, called National Disaster Management Information Service (NDMIS) referred to earlier would be established at NEOC-II of NDMA, which will be connected with State Data Centers, SEOCs and DEOCs with adequate data storage capacity. Upgradation of the NEOC-I at MHA with respect to its connectivity and capability would be done to establish, a mirror image for the Data Fusion Centre. The facility in NRSC, Hyderabad will serve as the Disaster Recovery (DR) site for NDMIS.

Key parameters that are considered as a part of NDCN architecture are Design based on

Standards, High Availability (with Redundancy and Diversity), Scalability, Optimization, Security and Integration.

Requisite number of routers and gateways coupled with hierarchal Network Management System (NMS) would provide the desired cross connectivity, redundancy and reliability by interconnecting various Networks from other users and departments (both public and private).

Assured Last Mile Connectivity & Communication Build-up at Disaster Site

Expeditious restoration of Communication at the disaster site from minimum essential to full scale, in graded manner, using a composite transportable Communication Pack consisting of:

- (a) Mini Mobile Communication Packs (MMCPs) to be provided to each of 312 Multi Hazard Prone (MHP) Districts, comprising of satellite based minimum essential Communication equipments for their immediate movement to the disaster site (on occurrence of a disaster for emergency resuscitation of communication). This MMCP would also be added with a Laptop to provide data communication from disaster site.
- (b) The bandwidth of MMCP will be enhanced through arrival of NDRF Battalions with Mobile Emergency Operation Centres (MEOCs) for providing voice, video and data communication. The requisite Communication infrastructure will comprise of INMARSATs (or equivalents), VSAT terminals, VHF

radio sets, etc

Highlights of Chapter -6 : Emergency Operations Centres (EOCs): Connectivity, Database & Applications Development

This chapter describes the EOCs at National, State and District level and the Mobile Emergency Operations Center (MEOC) for NDRF. EOCs are the main Command and Control facilities responsible for carrying out effectively the disaster management functions during all phases of natural disasters. It functions at full scale round the clock (24x7), after the receipt of first information about the occurrence of a major natural disaster.

Connectivity (among EOCs), applications and database requirements at EOCs are also dealt in detail in this Chapter.

The connectivity among EOCs and various stakeholders are established through satellite and terrestrial links. The applications required at EOCs relate to pre-disaster, during - disaster and post-disaster scenarios. At NEOC, there is special requirement for application development because NEOC also acts as a Data Fusion Center that receives the data (both spatial and non-spatial in GIS platform) along with hazard specific data for nodal agencies and collates them to provide knowledge- based information (in addition to conventional voice, video and data). The major application developments are Vulnerability Analysis and Risk Assessment System (VA &RA) for pre-event scenarios and Decision Support System (DSS) for relief and rescue management and damage assessment work.

The database regarding transport, rainfall, relief materials, shelter, census data, rescue teams, health and epidemic, administrative boundary etc would also be included.

Highlights of Chapter -7 : Facilities Provided at EOCs

This chapter deals with various provisions made at various levels of Emergency Operations Centers (EOCs) to facilitate efficient communication during disaster.

The communication facilities envisaged at National, State and District Emergency Operation Centers and the stations of NDRF Battalions provide for Static Communication Access Platform (SCAP) while those for NDRF and District Headquarters will have, in addition, the facility in the form of Mobile Communication Access Platform (MCAP). EOCs at National, State and Districts levels will have both terrestrial and satellite (for failsafe backings) connectivity. The facilities at SCAP include IT hardware and satellite connectivity while MCAP will consist of requisite IT hardware along with wireless connectivity (based on satellite and VHF system). As a part of the proposed Mobile Emergency Operation Centre (MEOC) of NDRF, the communication needs within the NDRF team members and those of the local authorities will be met through satellite connectivity and VHF system, establishing voice, video and data communication from the disaster site to other EOCs, NDMA Headquarters, MHA, NDRF headquarters in a graded manner (with satellite phones for immediate contact and VSAT based phones for regular communication).

Additionally, mobile handsets with CUG

(Close User Group) Connection is provided to the identified members of NDRF for mobilizing the force in the quickest manner (by sending SMS in the event of a disaster).

Mobile Communication Packs (MMCP) will be provided at the District Headquarters of 312 Multi Hazards prone (MHA) districts in the country to fulfill the need of emergency requirements. MMCP can be transported immediately to the disaster affected site by the district authority for establishing contact, till the national level resources are deployed. Each MMCP will consist of portable satellite phone equipment and VHF based wireless equipment, which can establish immediate communication after reaching the disaster site.

Highlights of Chapter-8: Technological Challenges for Implementation of NDCN

This chapter brings out the technological challenges involved in establishment of an effective, responsive and integrated National Disaster Communication Network in India.

In addition to terrestrial links, the need for quick deployment of a wireless based communication support (satellite and VHF) is an essential feature of NDCN for quick establishment and requisite mobility with adequate bandwidth for back-haul linkages. The communication built-up is to be carried out in a graded manner i.e. immediate voice communication on reaching the site and subsequent scaling up to video and data communication in a short period. It is important that redundancy and diversity should be built in (to achieve the necessary resilience for failsafe character).

In addition to above, establishment of Disaster Management Information System with requisite data fusion centre at National level and data centres at State and District levels at the respective EOCs for effective management would be this added technological challenge.

Integration with other satellite networks as well as interfacing with local service provider networks is essential for efficient disaster management. Consequent to disaster, operation and maintenance of the NDCN network involving complex array of hardware and associated software components would have inherent implications in the area of Logistic Support and Maintenance (in terms of spares, repair, software updation and so on) to meet the required level of availability of the network. Adequate provisions are also to be made for dynamic upgradation of the network in an evolutionary manner and in tune with the emerging technologies

A major challenge would be the language barrier in the effective deployment of technologies across the country, (which has a large number of regional languages), especially in providing early warning and forecasting systems and establishment of multi lingual call-centers at district, state and national levels.

Highlights of Chapter - 9: Technology, Emerging Trends and R&D Requirements

This chapter deals with the basic telecommunication principles and describes briefly the various telecommunication Network technologies.

The various multiplexing and

modulation technologies are adopted for increasing the traffic carrying capacity in the telecommunication network. Traditionally the telephone network was voice centric but with the rapid technological advancement, it has evolved into a telecommunication network with the convergence of voice, video and data and has been transformed into a multi-service network. The telecommunication network technologies described in this chapter cover satellite communication, optical fiber communication, cellular mobile communication, Wi-Fi, WiMax, PMRTS (Public Mobile Radio Trucking Solution) and VHF. The emerging trends in communication and Information technology and the related R&D effort requirements are also dealt with.

Satellite communication offers an economical solution for covering large areas, especially connecting remote areas, for providing instant broadband coverage without communication media problems relating to last mile connectivity.

Optical fiber communication provides large bandwidth (in the range of terabits) at an economical tariff with the introduction of Dense Wave Division Multiplexing (DWDM), which is a wire line technology with voice, video and data transmitted as optical signal through an optical fiber.

Cellular Mobile communication has introduced the concept of communication from any place at any time. It offers communication on the move, without being tied down to a traditional telephone at a location. Two kinds of international standards for cellular mobile exist, viz GSM (Global System for Mobile) and

CDMA (Code Division Multiple Access). Systems have evolved over the years, denoted by their Generation of evolution (1G, 2G, 3G), relating to technological progress in providing more and more enhanced services from voice to multimedia support.

Wireless Fidelity (Wi-Fi) is the beginning of wireless data transmission especially within a building providing, data access without the need of physical wiring. Wireless Fidelity technology provides data (Internet) access limited to a few hundred meters.

Worldwide Interoperability of Microwave Access (WiMax) is a wireless access service designed to provide IP connectivity over wide geographical areas, serving large number of users at low cost. WiMax is emerging as a wireless technology providing voice, video and data based on open standards, promising low cost solutions for rural broadband connectivity to eliminate the last mile connectivity problems. Added advantage of WiMax technology is its suitability for producing portable equipments, which can be set up at short notice for establishing communication facilities at disaster affected site.

Public Mobile Radio Trunking System (PMRTS) is a two-way radio employing "one - to- many", "point -to- multipoint" type of calling system. Captive Networks can use this technology, as it offers certain features such as fast call set-up time, excellent group communication support etc, which are not possible in public cellular network. They also offer modular system, which can be easily deployed for disaster situations compared to public cellular network. VHF systems are ideal

for short distance wireless communication and these have been traditionally used in group communication due to their ruggedness and simplicity of operation. The emerging scenario promises revolutionary changes such as RF Identification system (RFID), MIMO (Multiple Input Multiple Output) system for Software Defined Radio (SDR), Cognitive Radio (CR) for spectrum sharing and flexible spectrum usage, Unified Messaging System, Next Generation Network (NGN), IPv6 etc. These technological advancement will enable miniaturization, enhanced software features, optimum spectrum utilization etc.

There is therefore a need for a sustained R&D effort to explore various possibilities of multi service platforms, spectrum management and sharing, dynamically configured adaptive networks, fuel cells as power pack at disaster site etc.

Highlights of Chapter -10: Last Mile Connectivity

Last mile connectivity is the first casualty in case of disaster. The primary purpose of designing NDCN is to ensure communication link in the incident area within the earliest time possible by establishing last mile connectivity. The communication build-up is to be carried out in a graded manner i.e. immediate voice communication on reaching the site and subsequent scaling up to video and data communication in a short period. This chapter describes in detail the communication support envisaged to be provided for establishing graded communication at the disaster site. The communication support will be established in a

phased manner as briefed below:

Phase-1: The district authorities will be equipped with a portable Mini Mobile Communication Pack (MMCP), which will consist of satellite phones (INMARSAT/INSAT) and VHF radios. The Incident Commander, nominated by District authority, will transport the portable MMCP to the disaster site and establish the first communication link with District authorities within 15 minutes after reaching the site using MMCP.

Phase-2: NDRF are provided with satellite phones (INMARSAT/INSAT), VSAT terminals for INSAT, full complement of VHF system, cameras, laptop etc in a Mobile Emergency Operation Center (MEOC) duly wired up and kept in ready-to-use condition, which would be transported to the site. MEOC will be established at the site ranging from ½ an hour to 3 hours in a graded manner (after reaching the site). MEOC will provide fail- safe communication through satellite with sufficient bandwidth to send pictures and data in addition to voice. The complete need for the NDRF battalions as well as for the important local authorities would be fully taken care of by the proposed MEOC.

Phase-3: Depending upon the extent of damages, restoration of normalcy in communication at disaster site would be restored with the assistance from the telecomm service providers operating in the area within 2 to 7 days.

Highlights of Chapter -11: Implementation of NDCN

Implementation should ensure timely rollout of the NDCN network, meeting the

specified standards as well as the quality requirements. The activities in the implementation of NDCN center around four important segments viz- Planning and Execution of the network, Operations Support, Training of Manpower and Network Maintenance.

As the architecture of the network requires integration of various terrestrial as well as satellite based communication equipments along with interfacing components, it is strongly recommended to appoint a qualified and highly experienced agency for implementation of NDCN as a turnkey project. It will ensure adherence to quality standards, timeline for completion and proper up-keep of the network for its efficient use.

Operations support at EOCs will be provided by appropriate operational staff of SDMA, who have been properly trained with the requisite technical background of the network and infrastructure.

In order to ensure that the operational staff are familiar with the operations for the effective utilization of NDCN, adequate and periodical training will be imparted. Network Maintenance of NDCN, which involves day-to-day activities on (24X7) basis, the task to ensure proper functioning of the various types of systems/subsystems should be entrusted with the implementing agency itself for the initial period of 5 years who is fully familiar with the infrastructure. This would ensure proper upkeep of the equipments, rectifying the faults as and when occurs and carryout

periodical functional tests. They should also include proper and regular monitoring required to ensure the availability of network as well as the leased bandwidth is above 99%. SLAs are strictly to be adhered to by the service providers accordingly.

During management of live disasters, operational staff could be reinforced by suitably co-opting manpower / experts from agencies like IMD, CWC, Police etc. Reinforcement for technical staff could also be arranged from the service providers through Memorandum of understanding.

The project will be a central government Sponsored programme and it will be funded by Central Government for implementation and subsequent Network Maintenance of NDCN

Chapter -12: Summary of Action Points:

To derive the benefits of these Guidelines, stakeholders at various level of administration need to take actions for converting the Guidelines into respective action plans. In this Chapter, the action points, which need to be initiated at various levels, have been summarized. The action items for the implementing agencies are also furnished. Such compilation at one place is intended to help easy reference to the action items, which are essential to be executed for the creation of an ICT based platform required for achieving NDMA's goal for holistic management of disaster.

1.1 Introduction

Due to unique geo-climatic conditions prevailing in the Indian land mass and its geo-physical nature, India has been witnessing different types of devastating natural disasters like floods, cyclones, earthquakes, landslides, droughts, tsunami etc at regular intervals, causing huge loss of life, property and damage to the environment and hence, considered as one of the most disaster prone country in the world. During the last four to five decades, vulnerability to disasters, both natural as well as man-made, have been increasing due to rising population, haphazard urbanization, structural development in high risk zones, environmental degradation, climate change etc.

Tragically, disasters continue to affect mostly the poorest and least developed. While countries with a low human development index reported the fewest natural disasters during the last decade (compared to countries with a high human development index), the number of deaths for each disaster is by far the highest in these countries. An average of 555 people died per disaster in countries with a low human development index, compared to 133, where there is a medium human development index, and 18 in countries with a high human development index (like US, Japan, Europe and so on).

Since its earliest days, communication has played an important role in Disaster Management (DM), in providing information to all the stakeholders, particularly in rescue and emergency relief operations to the disaster affected victims. Perhaps, no more graphic example can be found than in the events surrounding the sinking of the "Titanic" on April 14th, 1912, when Radio communication technology was instrumental in soliciting aid from the nearby vessels "California" and "Carpathia" which were able to proceed to the rescue of the people.

Advances in Information and Communication Technology (ICT) have made it possible to not only forecast some of the disasters but also to have made available means, for quick and effective rescue and relief operation, thereby minimizing the deadly impacts of some of the worst disasters. For instance, compared to more than 10,000 killed during the cyclone that hit Andhra Pradesh in 1979, improved communication techniques limited the loss to less than 1000 during the May 1990 cyclone of similar intensity in the same state. In the neighbouring Bangladesh in the early 1970s, a cyclone killed more than 300,000 people. However, after the country put in an extensive early warning system, a recent cyclone of similar intensity resulted in loss of 3,000 lives.

Even though the global average of number of disasters has been rising rapidly, improved warnings and mitigation programmes have reduced significantly the number of human lives lost in the technologically advanced nations. The United States of America has one of the higher rates of natural disasters in the world, but, the number of lives lost every year in that country due to natural disasters has been drastically decreasing over the years, compared to increasing global average. The global disaster costs are, however, rising, in terms of damages caused. These rising costs are the combined result of rapid urbanization and growth of increasingly complex as well as costly infrastructures particularly in high-risk coastal areas.

Clearly, no society is immune to the natural disaster threat. As the risk continues to grow, it is imperative that the technological advances be harnessed to aid the disaster managers in reducing loss of life and property. Just as the Internet and the WWW have provided a new paradigm for communications, the explosive growth of new technologies provides unprecedented new opportunities and capabilities for the disaster managers.

In India, early warning (EW) for cyclone bulletins are transmitted in local languages by the nodal agency, India Meteorological Department (IMD), through a network of analogue and digital receivers distributed in the field. Similarly, flood forecasting and EW services are being rendered by Central Water Commission (CWC) to cover almost all major flood prone inter-state river basins of India. Further to enhance the efficacy of the existing

systems, the respective nodal agencies (namely IMD and CWC), have already initiated plans for upgrading the EW systems through wider coverage of the areas with large numbers of advanced monitors and dissemination of the warning through extended networking of fail-safe communication systems

Since the December 2004 Indian Ocean tsunami, the Asian Disaster Preparedness Center (ADPC) together with the International Telecommunication Union (ITU) have taken initiatives to study the current situation of emergency communications in the Asia-Pacific countries and to give recommendations on national emergency telecommunication and national early warning system setups. Assessments were made in Bangladesh, Maldives and Sri Lanka on these emergency communication systems. To enhance early warning systems, ADPC, under the Indian Ocean Early-Warning Systems Programme, also introduced the Tsunami Alert Rapid Notification System Programme, with emphasis on robust ICT systems to disseminate information and warnings from the national to the community level. Similarly in India, steps have been taken with setting up of the Regional Tsunami Warning Centre (RTWC) at Indian National Centre for Ocean Information Services (INCOIS), Hyderabad, which has become operational since December, 2007.

Revolutionary advances in the areas of communication, remote sensing, modeling and simulation capabilities, GPS linked Geographic Information Systems (GISs), and spectacular growth in IT, offering computational capacity at an affordable cost with open standard platforms

on one side, and software tools and techniques for data viewing and visualization etc on the other side, are leading to a paradigm shift in disaster management information system in several developed countries. Instead of traditional response centric approach for disaster management, utilising multi-services voice, data and video, through a dedicated and reliable communication network, emphasis is now shifted to provide knowledge-based information to all the stakeholders for a holistic management of disaster in a pro-active manner, assigning priority to the pre-event scenarios of prevention, mitigation and preparedness programme to ensure faster and more efficient rescue and relief operations during the emergency and to build better, in the post-event scenario leading to disaster resilience in the society (which is essential for the sustainability of the development efforts in a country).

1.2 Paradigm Shift in DM at Global Level

1.2.1 Initiatives on Natural Disaster Risk Reduction Programme

Every year, natural disasters result in enormous loss of life and property, leading to set back in economic and social development by years, if not decades. Between 1980 and 2005, nearly 7500 natural disasters struck worldwide taking the lives of over 2 million people and causing economic losses estimated at over 1.2 trillion US dollars.

Natural Disaster cannot be prevented at the present level of Science & Technology (S&T) and community may have to live with certain level of risk – the level of risk being dependent

on the level of Science & Technology (S&T) available for induction in DM and the resources made available by the Government for its actual induction for holistic management of disaster in a proactive way. Holistic management of disaster calls for assigning priority in the prevention, mitigation and preparedness activities in the pre-disaster scenario of the DM continuum, while strengthening the efforts for faster and more efficient response through properly trained personnel, equipped with advanced equipment/instruments and building better during rehabilitation and reconstruction period. In the context of natural disasters, therefore, the holistic DM cycle has been centered on four overlapping phases: mitigation, preparedness, response, and recovery. Science & Technology (S&T) driven knowledge-based information infrastructure is required to provide balanced support to each phase of these activities in DM cycle. Disaster management continuum is shown in **Annexure 1**

Based on this realization, there has been a paradigm shift in approach to DM world over from erstwhile response centric to a proactive and holistic one. Starting with the UN General Assembly meeting on 11th December, 1987, same sentiments have been echoed in the world conferences on natural disaster reduction- first at Yokohama in 1994 and then at Hyogo, Kobe in 2005.

It has now been recognized that disaster prevention, mitigation, preparedness and response are the four elements along with environmental protection that are closely interrelated with sustainable development and hence nations should mainstream them in

their development plans and ensure efficient follow-up measures at all the levels of DM administration for sustainable development. The approach adopted by UN is detailed in **Appendix-I**.

Despite the rising global trend in the occurrence of disasters and associated economic losses, global loss of life associated with geophysical, meteorological, hydro or climate-related hazards in 2005, decreased to one-tenth of levels in the 1950's. This remarkable decline is a demonstration that mitigation, preparedness and capacity development combined with effective early warning systems and disaster management, can significantly reduce the impacts of hazards on human life. This was acknowledged during the Second World Conference on Disaster Risk Reduction (Hyogo, Kobe, Japan 18-22 January 2005) when 4000 participants from 168 countries adopted the Hyogo Framework for Action (HFA) 2005-2015 for Building the Resilience of Nations and Communities to Disasters.

HFA calls for a paradigm shift-from emergency response to disaster risk management in a more proactive and holistic approach where augmentation of existing multiservices (of voice, data & video) with knowledge-based Information Services would play a crucial role.

1.2.2 Global Initiative of Tampere Convention on Deployment of Telecommunication Resources for DM

At the Intergovernmental Conference on Emergency Telecommunications (ICET-98) at Tampere, Finland, held on 18 June, 1998, a legally binding international treaty on deployment of Telecommunication Resources

was unanimously adopted by 75 countries and it was recognized that the effective, timely deployment of telecommunication resources for rapid, efficient, accurate and truthful information flows are essential for reducing loss of life, human suffering and damage to property and the environment caused by natural disasters. India became signatory to this Tampere - Convention on 29th November, 1999.

Timely deployment and use of telecommunication resources, play a crucial role in life saving, ("telecommunication resources" meaning personnel, equipment, materials, information, training, radio-frequency spectrum, network or transmission capacity or other resources necessary for telecommunication) disaster mitigation ("disaster mitigation" means measures designed to prevent, predict, prepare for, respond to, monitor and/or mitigate the impact of disasters), and relief operations ("relief operations" meaning those activities designed to reduce loss of life, human suffering and damage to property and/or the environment caused by a disaster).

The participating parties were therefore, concerned about the possible impact of disasters on communication facilities and information flows and, affirmed the extreme importance to establish telecommunication resources at the national level and cooperation amongst various member States and non-state entities to facilitate the use of same.

It was also decided that for prompt telecommunication assistance to mitigate the impact of a disaster, telecommunication resources should include, but is not limited to, the deployment of terrestrial and satellite

telecommunication equipment to predict, monitor and provide information concerning natural hazards and health hazards ("health hazard" meaning a sudden outbreak of infectious disease, such as an epidemic or pandemic, or other event posing a significant threat to human life or health, which has the potential for triggering a disaster).

In this context, the need for reduction or removal of Regulatory Barriers was also stressed upon and decided that the States shall, when possible and in conformity with their national law, reduce or remove regulatory barriers to the use of telecommunication resources for disaster mitigation and relief. Regulatory barriers may include, but are not limited to regulations: (i) restricting the import or export of telecommunication equipment; (ii) restricting the use of telecommunication equipment or radio-frequency spectrum; and (iii) revising the regulations.

1.3 Natural Hazard Profile in India and Special Features of ICT Systems

Floods, cyclones, droughts, earthquakes, landslides and other hazardous events like tsunami are a recurrent phenomena in our country, causing huge loss of life, property and damage to the environment (because of which India is considered as one of the most disaster prone country in the world). Nearly 58.6% of the Indian land mass is prone to earthquakes of various intensities; about 12 % of the Indian land mass covering over 50 million hectares is prone to floods and resultant land erosion; approximately 8% of the total area is prone to

cyclones and 68% of the area is susceptible to drought. Out of India's long coastline of approximately 7516 kms, approximately 5700 kms is prone to cyclones and Tsunamis.

Landslides are one of the natural hazards that affect at-least 15% of land area of our country exceeding 0.49 million square km. Landslides of different types occur frequently in geodynamically active domains in Himalaya, Northeastern India as also in stable domains in Western Ghats and Nilgiri Hills of southern India. Landslides have had disastrous consequences and in 2005, over 500 lives were lost due to landslides. The losses in terms of private and public assets have been astronomical.

During the last four to five decades, vulnerability to disasters, both natural as well as man-made, have been increasing with rising of population, haphazard urbanization, development in high risk zones, environmental degradation, climate change etc. (List of major disaster in India is furnished at **Annexure 2 & Annexure 3**) In the by gone decade 1990 to 2000, approximately 4500 people lost their lives and nearly 15 million people were affected by the various disasters.

1.3.1 ICT for Flood Management : Special Features

India has a large number of catchment areas, rivers and related river basins. Floods have been a recurrent phenomena with concomitant loss of lives, properties, infrastructure and public utilities. In fact, floods in some of the States like Assam and Bihar are a cyclic phenomena. Another issue on effective DM during floods is the fact that some of the causes of floods

and consequent damages in India originate in neighbouring countries that add new dimension to the complexities involved in early warning (EW), forecasting mitigation and preparedness activities in DM continuum.

India is regularly affected by floods due to the high discharges in the Ganga-Brahmaputra-Meghna river system. The main causes of floods are widespread heavy rainfall in the catchment areas and inadequate capacity of the river channel to contain the flood flow within the banks of the river. In the tidal reach areas, widespread inundation occurs where high floods in the river synchronises with the high tidal levels from the sea. The discharge of the river Brahmaputra is mostly contributed by the snowmelt in China (Tibet) on the other side of the Himalayas before it enters Arunachal Pradesh. In Arunachal Pradesh, Assam and Meghalaya, rainfall is quite heavy and this contributes substantial amount of flow in the river.

The Brahmaputra River causes specific problems in Assam due to siltation, which requires periodic dredging of the riverbed on priority to minimise the impact of flood and soil erosion. Satellite imagery of flood affected areas on GIS platform will enable Decision Support System to guide flood mitigation program.

Inter-state coordination, with installation of an automatic Alarm System employing **appropriate level/discharge** sensors, can be used to pre-empt disasters. Effective and timely information systems, and contingency plans for dealing with such disasters, are the answers. The present manual system of marking of water level is to be converted to an automatic danger level overflow alarm system using intelligent sensors,

which will flash the information instantly to the State Emergency Operations Centre (SEOC)/ District Emergency Operations Centre (DEOC) and will enable quick evacuation and save lives and property, is the need of the hour.

Flooding along with major river basins such as Brahmaputra, Ganga, Yamuna and so on dictates requisite communication support system, warning, forecasting, preparedness and subsequent response and recovery. This impacts positioning of communication centres, towers and allied power pack equipment. This also dictates requirement of mobile communication equipment, whether man-portable, or transportable on Vehicles, Boats and Helicopters.

An emerging dimension in the floods scene is the flooding in cities and towns. This is a rising phenomena due to increasing incidents of sudden and heavy rainfall, unplanned management and indiscriminate encroachment of waterways, inadequate drainage and lack of maintenance of its infrastructure.

Recent floods in Mumbai in 2005 are a glaring example as regards urban flooding is concerned. Management of urban flooding impacts Communication and IT requirements in the densely populated areas in its own unique ways.

National Remote Sensing Center (NRSC) Satellite data can be used very effectively for mapping and monitoring the flood inundated areas, flood damage assessment, flood hazard zoning and past flood survey of river configuration and protection works. Flood hazard map of India is given at **Annexure 4**.

1.3.2 ICT for Cyclones Management: Special Features

Cyclonic vulnerability in a recurrent fashion is a ground reality for the Indian Sub continent. India, with a long coastline of approximately 7500 KMs of flood coastal terrain, high population density, geographical location, topological feature of its coastal zone, is extremely vulnerable to cyclones and related hazards like storms tides, high velocity winds and heavy rains. In fact, nearly 1/3rd of the country's population is vulnerable to cyclone related hazards. Within 13 Coastal States and Union Territories, 84 coastal districts are affected one way or the other by tropical cyclones. Four States namely Tamil Nadu, Andhra Pradesh, Orissa and West Bengal and Union Territory of Puducherry along the east coast and Gujarat in the west coast are more vulnerable to cyclones and associated hazards.

This vulnerability, coupled with a large geographical spread, dictates a comparable intensive deployment of EW, forecasting and ICT support over the entire DM continuum. From the ICT angle, the key facet, which needs to be clearly understood, is the terrain configuration, with related geographical complexities and demographic diversity, which is to be taken into consideration while planning for ICT systems. Of particular concern are the issues related to proximity of Communication Centres and related POPs (Points of Presence) to the coast lines as also capabilities of communication towers to withstand high cyclonic wind pressures so that these are not damaged or destroyed during cyclone, when most needed.

The cyclone prone districts are distributed across the coastal States and Island territories of the country and have diverse topographical conditions. The network technology to reach the EW to the last mile must be able to operate under these diverse topographical conditions in each of the 13 cyclone prone States/ UTs in the country. Timely receipts allow sufficient lead time for the community to respond to the advice received from the district/sub-district level and take appropriate action.

The typical duration of a cyclone, that hits the Indian coast, is 3 to 4 days from the time it forms to the time it hits the land. The lead time from detection of a cyclone to dissemination of the warning is variable and depends on the distance on the point of formation from the coast.

Wind and Cyclonic hazard map of India is given at **Annexure 5**.

1.3.3 ICT for Earthquake Management: Special Features

The damage potential of earthquakes covering nearly 59% of Indian landmass has major impact on ICT infrastructure, because of the very vast geographical spread as also difficult terrain such as that of Jammu & Kashmir, Himachal Pradesh and so on.

The ICT requirements, therefore, have to cater for requisite support in a very short span of time, since the earthquake related disasters very rarely gives any early warning indicators. Earthquakes also affect the mobility of the ICT elements, in addition to causing considerable damage to the existing infrastructure resources; whether public or private in the affected areas.

It is, therefore, imperative that these backdrop issues are taken into account while planning for earthquake related ICT support for the activities involved in the complete disaster continuum.

Earth quake related seismic zone map of India is given at **Annexure 6**.

1.3.4 ICT for Landslides Management: Special Features

Landslide includes all varieties of mass movements of hill slopes downward and outward of materials composed of rocks, soils, artificial fills etc. Recurring impact of these is felt in twenty-one states and Mahe Enclave of Union Territory of Pudducherry to a variable extent. Due to the frequent recurrence, landslides are identified as a major natural hazard bringing untold misery to human settlements and devastating damages to transportation and communication network.

Out of the entire world's landslide, 30% occur in Himalayas, indicate the SAARC study. Ill planned road building are to be blamed for widespread wastage of land resources, which forces rural community to encroach into forests and further aggravate soil erosion. However, natural processes like monsoon and cyclone induced rainfall play a greater role than the human induced ones. Even though landslides are mainly triggered by earthquakes, many other factors contribute to slides, viz geology, gravity, weather, groundwater and wave action, and human actions like indiscriminate tree felling, construction, mining and quarrying combined with heavy rainfall have increased the fragility of the Himalayan Mountains, leading to an increase in the incidence of landslides in the region.

The landslides not only hamper the mobility but also cause damage to the ICT structures. The provision of ICT systems needs special care, considering the terrain and the hazard. ICT using satellite communication provides the solution to establish connectivity in case of such devastating situations.

Landslide hazard zonation map of India is given in **Annexure-6A**.

1.4 Paradigm Shift in DM in India

Keeping in mind, the hazard profile of the country and its impact on the national economy at regular intervals in general and the impact of the last few major disasters in particular viz i) Orissa, Super cyclone (29th October, 1999), ii) Bhuj Earthquake (26th January, 2001), iii) Tsunami (26th December, 2004) and iv) J&K Earthquake (8th October, 2005) resulting in the loss of about 40,200 lives and Rs 34,400 crores worth property, India decided to switch over from erstwhile reactive and response centric to a proactive and holistic management of DM by inducting science and technology in all the elements of DM continuum on 23rd Dec, 2005, when DM act was passed unanimously by the Parliament. Broadly this approach calls for, interalia, development of the essential scientific and technological infrastructures, establishment of an advanced technology based reliable and dedicated National Disaster Management Information and Communication System (NDMICS) which would play a decisive role.

The Disaster Management Act 2005, clearly spells out the organizational structure with corresponding functional responsibilities

for DM in India. At national level, the Disaster Management Act, 2005, has envisaged the National Disaster Management Authority (NDMA), the apex body headed by the Prime Minister as the Chairperson. In essence, NDMA is to concentrate on prevention, preparedness, mitigation, rehabilitation, reconstruction and recovery phases of disaster besides formulating appropriate policies and guidelines for effective and synergized national disaster response and relief. Furthermore, being the highest policy making body for disaster management in the country, it is also to coordinate the enforcement and implementation of its policies and plans. The Disaster Management Act, 2005 has thus created certain institutional bodies from within the existing administrative structure, with statutory duties in connection with disaster management at all the levels of governance, i.e. National, State and District.

A diagrammatical representation of the National Disaster Management Structure is given at **Annexure 7**.

For providing immediate response, National Disaster Response Force (NDRF), which is fully trained and equipped to handle all major natural and some of the man-made disasters like Chemical Biological Radiological and Nuclear (CBRN), has been raised and it works under the general superintendence, direction and control of the NDMA. It is located in different regions of the country as per the vulnerability profile of the region/area. The locations of various existing NDRF Battalions are as follows and they have been shown in **Annexure 8**. Some more NDRF battalion may be raised in future and located at other strategic locations.

All the components of the Institutional structure of DM are required to have desired ICT connectivity and support, for effective coordination and management. The list of early warning and forecasting agencies requiring due connectivity is given at **Annexure 9**.

Certain specific contents of Disaster Management Act are a clear pointer towards

S.No	Location	NDRF Bn.
1	Kolkata (West Bangal)	2 nd NDRF Bn
2	Guwahati (Assam)	1 st NDRF Bn
3	Vadodara (Gujarat)	6 th NDRF Bn
4	Pune (Maharashtra)	5 th NDRF Bn
5	Arakonam (Tamil Nadu)	4 th NDRF Bn
6	Mundali (Orissa)	3 rd NDRF Bn
7	Bhatinda (Punjab)	7 th NDRF Bn
8	Greater Noida	8 th NDRF Bn
9	Patna (Bihar)	9 th NDRF Bn
10	Guntur (Andhra Pradesh)	10 th NDRF Bn

some specific components of disaster management along with related Information and Communication Technology (ICT) infrastructural

support measures. Portions of the Act concerning Information & Communication Technology (ICT) Infrastructure are enumerated below:

- | | |
|--|--|
| <p>(a) 30.2.ii. Implementation of national, state and district policies.</p> <p>(b) 30.2.iii. Prevention measures for mitigation of disasters to be undertaken by the departments of Government.</p> <p>(c) 30.2.v. Directions to different authorities for the prevention of disaster.</p> <p>(d) 30.2.xiii. Facilitation of community training and awareness programme.</p> <p>(e) 30.2.xiv. Setting up of mechanism for early warning and dissemination of information.</p> <p>(f) 30.2.xvi. Coordination of response to any threatening disaster situation or disaster.</p> <p>(g) 31.3.d.iv Establishment of communication links.</p> <p>(h) 31.3.d.v. Dissemination of information to the public.</p> <p>(i) 34.f. Establishment of emergency communication system.</p> <p>(j) 36.g.i. Providing emergency communication in a vulnerable or affected area.</p> | <p>(k) 38.h. Providing adequate warning systems.</p> <p>(l) 39.a. Capacity building in accordance with the guidelines.</p> <p>(m) 39.b. Integration of DM in development plans and projects.</p> <p>(n) 39.e. Reviewing enactments of plans and policies.</p> <p>(o) 42.g. Promoting awareness among stakeholders.</p> <p>(p) 42.h. Organizing conferences and lectures.</p> <p>(q) 54. Intentional false alarm or warning – punishable offence.</p> <p>(r) 67. Recommendation of any authority or person in control of audio or audiovisual media to carry out the necessary warning.</p> <p>(s) 74. Immunity from legal process in regard to warning of an impending disaster.</p> |
|--|--|

2

Requirement of ICT Network During Various Phases of Disaster Continuum

2.1 Introduction

Natural Disaster cannot be prevented at the present level of S&T and community may have to live with certain level of risk – the level of risk being dependent on the level of S&T available for induction in DM and the resources made available by the Government for holistic management of disaster in a proactive way, where priority is assigned in the prevention, mitigation & preparedness activities in the pre-disaster activities without diluting the effort on the post event activities. In the context of natural disasters, therefore, the holistic DM cycle has been centered on four overlapping phases: mitigation, preparedness, response, and recovery.

A knowledge-based information infrastructure for DM cycle needs to provide balanced support to each phase of these activities to reduce the level of accepted risk in the society. This chapter examines the requirement of ICT network during various phases of disaster continuum

Disaster information management has traditionally been adapted in an insular environment because of which interaction between the Stakeholders involved in the four

stages of DM cited above has been minimum and, the DM-tools that have been developed to support the various disaster phases being improper and non-uniform in nature. A holistic approach calls for a seamless flow of various information products developed whereby the product used in the response stage can be fed back into the mitigation programme to incorporate the changes required on a common platform.

While the preparation and response phases are characterized by high timeliness and reliability needs along with highly variable volume of data to be sent to a limited stakeholders, mitigation and recovery phases require ICT support that have less urgent delivery needs and a broader stakeholder spectrum (e.g., government, academics, builders, insurers, etc.), even though often cannot accept long delays.

The requirements peculiar to each phase of disaster management and the implications to information systems and components employed are discussed below.

2.2 ICT for Mitigation Phase

Consists of pre-disaster activities necessary to be implemented in advance for

reducing the impacts of disasters such as the development and promulgation of zoning ordinances and building codes and creation of the critical baseline data alongwith analysis and modeling capability needed to prepare for, respond to, and recover from a disaster event. Mitigation may also include implementing legislation that prevents building structures in areas prone to earthquake, flood or tsunami. Utilizing existing databases linked to geographic features in GIS makes the task of monitoring these possible. For the most part, these activities are not time critical but are essential while designing the ICT infrastructure.

Networking requirements to support the mitigation phase should meet key attributes, like the need to move large volume of data/information, broad connectivity among a diverse group of organizations etc. However, in contrast to response and recovery, timeliness is generally not critical.

The data are largely archive-based, and hence several cataloged and linked repositories are to be accessed through good search engines or the directory systems should permit access to the distributed users. Data providers are responsible for data quality (timeliness and accuracy), limiting redundancy, and updating catalog/directory information. Use of modeling/prediction tools for trend and risk analysis is important. The scientific community increasingly relies on the Internet for access to data and scientific collaboration in supporting mitigation efforts.

2.3 ICT for Preparedness Phase

Preparedness activities range from early warning, community development, training

of the first responders and the community, logistical support, supply, and resource systems needed for disaster response to early warning and monitoring activities preceding the disasters.

Distribution of warning data through a dedicated network during the preparedness phase is intense, and timeliness becomes a critical factor for some types of information dissemination. Although disaster prediction accuracy and warning lead-times are improving, storm and earthquake alerts still require wide distribution in minutes or seconds.

In remote areas, for example, full national coverage is still a concern to be addressed to, through adoption of various technologies. Public awareness through broadcast announcements and access to disaster web pages are the key issues. Distance learning and other training activities making use of interactive video also fit into this category.

2.4 ICT for Response Phase

Response to disaster events is time critical. Logistical support option for providing relief materials, damage surveys, baseline maps, equipment, human resources, and funds all need to be accessible. Communications among response teams and to the general public become most vital.

Rapid, reliable, configurable, controlled-access communication is vital to efficient disaster response operations. Major challenges are presented by extreme conditions of infrastructure destruction, communication traffic peaks, mobile users, and sensitive data.

Management of property and casualty status, resource information, and response priorities require special access capabilities beyond normal commercial telephone/ Internet services.

2.5 ICT for Recovery Phase

Bulk of the data needs during recovery include significant onsite data collection related to rebuilding, claims processing, and documentation of lessons learnt.

Feedback on the mitigation process and historical databases that are important to prevent the same mistakes in the future. Timeliness concerns are relaxed in favor of efficiency, and internet is often ideal for such transfers.

It is, therefore clear that the requirement for access, privacy, and bandwidth varies among disaster phases. Today's disaster information infrastructure should offer an appropriate mix of component technologies to respond to diverse requirements. The Internet is suitable ICT support to the recovery and mitigation phases, but urgent and life-critical communications during the preparation and response phases call for systems that are more robust. Establishing a robust National Disaster Communication Network (NDCN) will meet the ICT requirement with assured response without failure.

Wireless media using mobile system such as portable satellite communications, wireless systems, etc as part of NDCN would meet the requirements during emergencies. ICT networks should use various technologies to provide a network meeting the requirement during all phases of disaster. Creative applications of broadcast technologies are also to be explored for warning and advisory systems.

Internet can be overloaded, leading to an extra burden on response time. Although through the addition of mirrored servers and similar approaches, a larger share of users can be expeditiously served, it may not be reliable for time-sensitive traffic such as warnings and interactive resource management, unless Internet traffic can be prioritized.

With the rapid development of mobile telephony, followed by web based communication, it has become an invaluable tool for disaster relief workers, which includes wide range of national and international aid agencies, (who are able to coordinate team activities while in the field, and quickly mobilize emergency actions such as evacuation).

2.6 GIS platform Inevitable for Holistic DM

It may be observed that satellite-based advanced technologies and GPS enabled Geographic Information System (GIS) would play a very crucial role to facilitate the various stakeholders in implementing knowledge-based information for holistic management of all activities of DM continuum.

Timely information on the occurrence, progression and regression of disasters during the various phases are essential for effective management of disasters and this can be derived by integrating the real-time aero-space imageries with the corresponding ground information (usually available on Geographic Information System (GIS) platform linked with Global Positioning System (GPS)). The obvious advantage for generating such dynamic map, unlike static map, is availability of real-time

information depicting the cause and effect relationship, that are extremely helpful to the disaster managers at every level of DM administration, including the community.

During the preparedness and response phases, GIS can accurately support better response planning in areas such as determining evacuation routes or locating vulnerable infrastructure and vital lifelines, etc. It also supports logistical planning to be able to provide relief supplies by displaying previously available information on roads, bridges, airports, railway and port conditions and limitations. Apart from this, activities such as evacuee camp planning can also be done using GIS.

Based on the information provided by GIS, it is also possible to estimate the quantity of food supplies, bed space, clothes, medicine, fire tenders, medical and paramedics that will be required at each shelter, based on the number of expected evacuees.

GIS facilitates online monitoring of the status of ongoing work in the recovery phase. As work is progressing and/or completed, GIS can visually display current project status. by quickly updating the data. Current status can be easily viewed and accessed at the centralized GIS interface in the National Emergency Operation Centre (NEOC).

Using information on GIS-platform, it is easy to visually observe the critical information on location, progression and / or regression of the disaster with real time and prepare appropriate action plans for post-disaster scenario of response efforts that can be

transmitted to various stakeholders (viz incident commanders at EOC's as well as the disaster response personnel) for quick and effective implementation with excellent coordination. Disaster relief workers and the private sector (e.g., insurance agencies) could use these GIS information products in the post-disaster recovery phase, replacing the current paper-and-clipboard approach.

GIS can display real-time monitoring of the progressive development of the emergency. Remote weather stations can provide current weather indexes based on location and surrounding areas. Wind direction, temperature and relative humidity can be displayed by the reporting weather station. Wind information is vital in predicting the movement of a chemical cloud release or anticipating the direction of radioactivity released etc.. Earth movements (earthquake), reservoir level at dam sites, radiation monitors, etc. can all be monitored and displayed by location in GIS. If necessary, this type of information and geographic display can be delivered over the Internet to the public.

While planning for ICT backbone for DM, the need for transporting value added information on GIS platform to the right people at the right time must be kept in mind.

2.7 Action Points

- (i) Utilisation of wireless technologies for disaster management
- (ii) Inclusion of GIS platform for holistic disaster management

3

Existing Communications Base and ICT Support – Situation Analysis

3.1 Introduction

There has been spectacular growth in the telecom sector in India during the last decade with the total subscriber base of 28.53 million in 2000 phenomenally rising to 806.13 million at the end of 31 January 2011. The overall teledensity has reached 67.67 as on 31 January 2011. The major contribution has been from wireless segment (which has been consistently showing addition of not less than 10 million subscribers per month on an average in the last few years). The total subscriber base of 806.13 million consists of wireless segment of 771.18 million customers with wireless teledensity of 64.74 as on 31 January 2011. Wireline segment is showing declining trend with total subscriber base of 34.94 million with wireline teledensity of 2.93. Urban areas have recorded subscriber base of 538.38 million with teledensity of 150.67 while the subscriber base in rural areas (which are steadily showing increase) have reached 267.74 million with teledensity of 32.11.

Telecommunication segment as on 31.01.2011 (source: TRAI's Press release No. 13/2011)

- ❖ Total Subscribers : 806.13 millions
 - Wireless : 771.18 millions
 - Wireline : 34.94 millions

- ❖ Teledensity : 67.67
- ❖ Broadband subscribers : 11.21 millions

Optical Fiber based Communication (OFC) Network has been extensively installed throughout the country by Government PSUs like BSNL, PGCIL and others as well as private telecom service providers like Reliance Communication, Bharti etc and there is already 800,000 km of existing fibre line laid by these service providers. A fairly large Satellite based communication networks also exist in the country viz NICNET, POLNET, and ISRO DMS Network to provide satellite connectivity. In addition, there are more than ten mobile service providers operating in the country. Similarly, there are networks specially established by the concerned agencies in the country disseminating early forecasting of different natural hazards.

Telecom connectivity has been assigned high priority in the effort to upgrade the rural infrastructure. Presently the last mile Public / Private network coverage caters for approximately 60% of villages, and in a couple of years, it is expected to cover 95% of the villages in the country. At the end of the financial year 2009-10, rural teledensity figure of 24.29% and broadband coverage of 79,165 village

panchayats have been achieved. Under the Bharat Nirman Programme, rural teledensity of at least 40% by 2014, and broadband coverage of all 2,50,000 village panchayats and setting up of Bharat Nirman Common Service Centers (CSCs) at Panchayat level by 2012 have been targeted by the Government to be achieved. Government buildings in rural areas will have broadband access and will be transformed into computer kiosks, with a number of terminals equipped with 100 MB internet broadband connections. The government is planning WiMax or wireless broadband connections in each panchayat in the first phase of the exercise, which may take upto 6 months time. In the second phase, each village will be connected by fiber over a period of 18 months.

In this chapter description of the various telecommunication networks as well as hazard forecasting and warning networks in the country has been furnished. Towards the end of this chapter, various technical options are also briefed along with the respective limitations in the existing communication and ICT support.

3.2 Existing Telecommunication Network of Various Service Providers/ Government Agencies

Various major communication networks already established in the country including those under various phases of implementation by different agencies are briefed under:

3.2.1 National Emergency Communication Plan (NECP), Ministry of Home Affairs, Govt. of India

The Ministry of Home Affairs, being the Nodal Ministry for Disaster Management, has taken the lead role on disaster management and mitigation in the country. United Nations Development Program (UNDP) has joined hands in this effort of MHA and implemented GOI-UNDP Disaster Risk Management (DRM) program in 169 most vulnerable Districts of 17 States.

The National Emergency Communication Plan (NECP), evolved in 2004, was for management of Law and Order, crisis and disaster situations. The Plan is primarily a satellite based network resting on POLNET, with NICNET and VPN (DMS) as standby supports. The voice centric and limited data handling capability system is aimed to provide communication links between National, State and District Emergency Operations Centres (EOCs) as well as Mobile and Transportable EOCs for deployment at emergency / disaster sites. The Plan was to be implemented in two phases, viz: Phase 1 by Aug 2004 and Phase 2 by March 2006. However, it is only the Phase 1 of the Plan, comprising of One VSAT terminal for NEOC at MHA, one mobile EOC for a disaster site, and six transportable communication sets for search and rescue teams of one NDRF Battalion that could be implemented by Aug 2006. Phase 2 of the Plan is yet to be implemented.

For providing communication cover to NDRF Battalions, six transportable communications sets, each comprising of one VSAT terminal, two INMARSAT type satellite phones and five VHF sets, have been procured for search and rescue teams of one

NDRF Battalion under Phase1 of NECP 2004. In addition, MHA sanction was accorded in January, 2006 for procurement of 180 VHF sets, 24 VHF Base stations, 10 portable Radio Sets and 26 Satellite phones, per NDRF battalion for eight battalions. These are yet to be procured.

3.2.2 Disaster Management Support (DMS) Network of ISRO

Department of Space (DOS) has embarked upon the Disaster Management Support (DMS) Programme as a prime application activity, to harness the benefits of the space based technology for the applications in disaster management in the country. As part of this task, Indian Space Research Organisation (ISRO) has recently established a VSAT based Virtual Private Network (VPN) under its Disaster Management Service (DMS) Programme operating on EDUSAT Satellite in extended 'C' Band. Various centres of Indian Space Research Organisation (ISRO) are involved in implementing different components of the DMS Programme.

The Decision Support Centre (DSC) established at National Remote Sensing Centre (NRSC), Hyderabad is the single window delivery point for aerial & space enabled inputs, together with other important data layers, for their use in the management of pre-disaster, during-disaster and post-disaster phases. The DSC has the provision to mobilise aircraft for obtaining aerial data. At present, the DSC is addressing natural disasters viz. floods, cyclone, drought, forest fires, earthquakes and landslides. The extent of flood inundation map derived from space data are made available at near real time basis for planning rescue and relief operations using VSAT based satellite communication network.

In Phase-1, the Network is planned to have 8 Primary Nodes (NRSC-Balanagar, NRSC-Shadnagar, INCOIS, CWC, GSI, IMD, SAC-ISRO and SOI), 6 Monitoring Nodes (PMO,MHA, PMR, CABSEC, NDMA and NIDM) along with 22 User Nodes at multi-hazard prone State-Capitals for Early Warning (EW) and forecasting purposes.

TDM/TDMA (Time Division Multiplex/Time Division Multiple Access) technology is used for user nodes where bandwidth requirement is less and shared bandwidth is required. SCPC (Single Channel per Carrier) is used at 8 primary nodes where bandwidth requirement is higher and a dedicated point to point connectivity is required.

All the Nodes are equipped with Voice (Voice over Internet Protocol), Data and Video-conferencing connectivity. The Primary Nodes and Hub can hold simultaneous Video-Conferencing with 5 User Nodes.

This VSAT based DMS-network with the Hub located at MHA (Nizammudin, New Delhi) operates on extended C-band (6.725 - 7.025Ghz for uplink and 4.500 - 4.800Ghz for down-link)

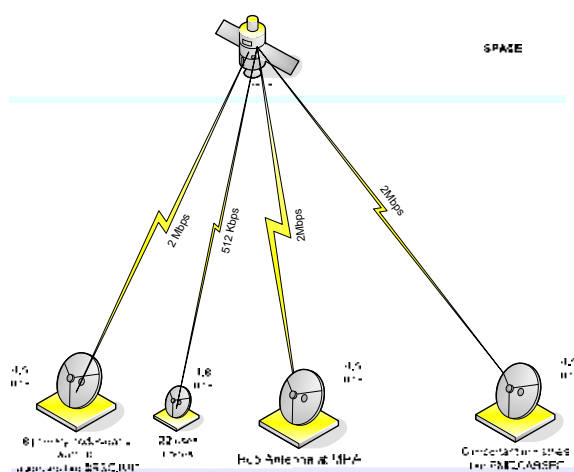

Figure 1: DMS Network

using one of the transponders of GSAT -3. Presently 36 VSATs have been deployed and the network is capable of expanding upto 600 Terminals. Additional 100 nodes will be installed after the State Governments identify multi-hazard zones.

The antennae at the primary nodes and HUB at MHA are 4.5 m in diameter while the antennae at user nodes are of 1.8 m diameter. The monitoring nodes at MHA, cabinet Secretariat, PMO, PMR, and NDMA also use 1.8M antenna with 2W Block Up-Converter (BUC).

Hub to Primary Nodes have two way 2Mbps data rate connectivity, while Hub to user nodes have two way 512kbps data rate connectivity. All user nodes are equipped with UPS and 10 hours battery backup. 36 nodes have been installed. Other nodes will be installed after site identification and clearance by state agencies. With the present available bandwidth on the network (27 Mhz), assuming 5 simultaneous video conference session, 120 simultaneous VOIP calls and 30 simultaneous data traffic, 600 sites can be supported . The nodes are operated by the respective state relief commissioners. HUB is to be taken over by MHA

3.2.3 Police Telecommunication Network (POLNET)

POLNET is a satellite based specialized wide area network for the modernization of Police Telecommunication of the country (operating on C-band of INSAT-3E) setup by MHA. POLNET is an amalgamation of different latest Very Small Aperture Terminals (VSAT) technologies i.e. TDM/TDMA, SCPC/DAMA (Demand Assigned Multiple Access) and DVB-S

(Digital Video Broadcast-Satellite). The HUB of POLNET is installed at New Delhi with 11 meter antenna with a capacity to support total VSAT Network of about 1500 locations for voice, data and fax facilities. TDM/TDMA VSATs work on double hop link through the central Hub at New Delhi for communication with other sites. State Headquarters with Hybrid VSAT terminal (Star and DAMA modes) can communicate directly with better voice quality utilizing single hop SCPC /DAMA Channel. The connectivity from District Headquarters (connected in Star mode) is being extended upto Police Stations / Police Posts through local Radio Network using MART (Multi Access Radio Telephone) system. POLNET also provides connectivity for interlinking NCRB computers to SCRB and DCRB computers at State/District HQs for online transaction processing.

Salient features of POLNET network are summarized below:

- a. Network size: At present 961 VSATs are operational and network can support upto 1500 VSAT terminals. VSAT Terminals with 3.8 meter antenna are installed at 41 locations at the capital



POLNET Network configuration

of States / UTs and some of the CPOs locations supporting both TDM / TDMA and SCPC / DAMA scheme for Star and Mesh connectivity while 811 TDM/TDMA V-SAT Terminals with 1.8 / 2.4 M Antenna size are installed at District Headquarters of all states and UTs and other important locations of CPMFs, MHA., NCRB, and CPOs etc. Remaining 109 are broadband VSAT terminals installed at various locations of BSF and ITBP. Out of the total, 40 nodes have a video transmission facility.

- b. The POLNET is planned to be expanded to cover all the Thanas as and when it is upgraded in 2 to 3 years time.
- c. Services :
 - Voice :
 - (a) Using VOIP on H.323 protocol & G.723.1 Coder in TDM/TDMA (Star Topology).
 - (b) using SCPC in Mesh topology
 - FAX Group III
 - Data Communication:
 - (i) using TCP/IP protocol over Ethernet
 - (ii) over X.25 network using serial port
 - Data Message Broadcast from any remote.
 - Video and Audio data Broadcast from HUB on scheduled basis.
- d. Connectivity: IDU (In Door Unit)-satellite modem provides two ports
 - (i) Ethernet 10Base T (RJ-45)

(ii) Serial Port (X.28)

Key observations relating to POLNET are as follows:

- a. This is a specialized network meant for the Police organization.
- b. Bandwidth constraints may limit the use of this network for high resolution images or video.

3.2.4 National Informatics Centre (NICNET) Infrastructure

National Informatics Centre is the nodal Information Technology organization for informatics development and networking in Government and related organizations. NIC undertook informatics research and development under its national programme called “Natural Hazards Management Information System in 1990 to support United National Natural Disaster Reduction Decade Programme. Presently NICNET connects all the Central & 35 State/ UTs Government Ministries/Departments in the country.

Today NICNET is primarily using terrestrial connectivity with a minimum of 2 Mbps to connect all districts in the country with the respective state capitals as NICNET has migrated from satellite based connectivity to terrestrial connectivity at all districts. The terrestrial connectivity is used for running all the three services such as data, voice and Video Conferencing. However, the VSAT connectivity is currently being used at locations where terrestrial connectivity is not available (< 5 to 10% locations) or as a backup during a failure in terrestrial connectivity. The backup for data service has been provided over the DVB

technology VSATs and the backup for VC service has been provided using the SCPC DAMA technology VSATs.

The leased line network has a central Network Management System (NMS), while each type of VSAT HUB has different NMS to manage the network. All the NMS are in CGO Complex, Lodhi Road, New Delhi . The Disaster Recovery site for NICNET is located in Hyderabad.

Important features of NICNET communication (both terrestrial and satellite) are given below.

- ❖ Terrestrial connectivity
 - Through dedicated leased lines of BSNL/PGCIL/RAILTEL
 - Most of the Central Government Ministries/ Departments in Delhi are connected through 10 to 100 Mbps connectivity.
 - The NIC State Centres are also connected to the center with high speed connectivity (45/100/155Mbps) and the backup/ alternative service is provided through leased lines. The state Government buildings are connected to NIC State centres with leased lines or user Dial-up facility.
 - 576 NIC- District units are connected from states with 2 Mbps lines.
 - The NICNET works on SCPC/ DAMA Mesh Networks and it works on V.35 interface as well as IP for Video Conferencing. Video-conferencing on NICNET

takes place based on prefixed schedule and at a rate of 384 Kbps or more.

- ❖ Satellite connectivity
 - It has distributed capacity on two satellites, Intelsat and INSAT, thereby providing adequate redundancy to the network. The network operates on five KU Band Transponders (four of 36Mhz and one of 72Mhz bandwidth) hired from Intelsat-906 and another ¾ Transponder (22.5 Mhz bandwidth) hired from INSAT-3A.
 - NIC's contract with the satellite operator for providing transponder capacity is expiring in mid 2011. NIC would procure the space segment beyond 2011 depending on various projects, which need satellite-based connectivity in that period.
 - NICNET has about 2500 VSATs operating in districts, blocks of Jammu & Kashmir, Chhattisgarh, Orissa and few North Eastern States.
 - The VSATs are of DAMA (for Voice/ Video) and DVB (only for data) technologies.

Another 2500 locations in North Eastern States where terrestrial / broadband services are likely to be available, are expected to get satellite connectivity under Common Service Centers (CSC) project funded by DIT in which NICS/NIC is to provide the HUB and the required satellite bandwidth. Service Centre Agency (SCA) identified by the state government in North Eastern States would procure the VSATs

at the CSC locations, which can operate on the NICS/NIC Hub.

Connectivity status of NICNET in disaster Prone Districts

All the identified departments and ministries for the disaster management at the state and district level are connected through NICNET.

Network	Connectivity in disaster prone districts:		
	P1(47)	P2(128)	P3(137)
NICNET	47	128	137

NIC District centers are located in Collectorates and depend wholly upon District Administration for logistic support like power supply, generator, space etc.

NIC State Centres are functioning 24X7 and NIC district centres are functioning from 8 am to 8 pm for providing ICT support to Government.

3.2.5 State Wide Area Network (SWAN)

As the major initiative for ICT support in the country, SWAN is the approved scheme of GOI for interconnecting state headquarters with District headquarters and District headquarters with Block headquarters with minimum 2 Mbps leased lines, in order to create secure government network for the purpose of delivering Government-to-Government (G2G) and Government to Center (G2C) services for supporting various e-Governance initiatives being taken by the respective States & Central Ministries. Under the National e-Governance Plan (NeGP) of Government of India (GOI), the Department of Information Technology (DIT), has earmarked a significant outlay of Rs.3334

crores with Rs.2005 crores as grant-in-aid from DIT for supporting this activity.

Under this Scheme, every State/UT HQ is connected in a tree/star connection upto the Block level, with minimum 2 Mbps capacity per link as shown in the diagram below. Link from State Headquarter(SHQ) to District Headquarter(DHQ) can be upgraded upto 4Mbps. All the government offices are connected with the respective PoP at the State/ District/Block level.

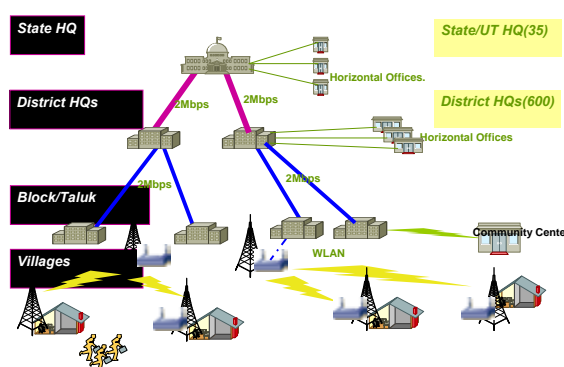

In the states, there are two options for establishment of SWAN viz: NIC model and PPP(Public Private Partnership) model. In both cases, private operators are involved either for operation of the network or for facility management services (FMS).

The entire process of outsourcing, including advising on the most appropriate PPP model, could be implemented by an appropriate consultancy organization in a transparent process under the direction of the implementation committee to be established by the State.

3.2.5.1 Status of Implementation of SWAN

SWAN was planned for all the 35 states/UTs, however, two of these have opted out

of SWAN viz Goa and Andaman and Nicobar Islands, which have their own wide area network.

Status of SWAN implementation is as follows:

- SWANs in 19 States/UTs namely, Haryana, Himachal Pradesh, Punjab, Tamil Nadu, Gujarat, Karnataka, Kerala, Jharkhand, Chandigarh, Delhi, Puducherry, Tripura, Lakshadweep, West Bengal, Sikkim, Chhattisgarh, Uttar Pradesh, Orissa and Maharashtra have been implemented.
- Implementation in the 4 States namely, Assam, Madhya Pradesh, Bihar and Uttarakhand are in advanced stage. Network trials are being conducted at different tiers of SWAN.
- The 4 States / UTs namely, Andhra Pradesh, Arunachal Pradesh, Manipur and Meghalaya have identified the Network Operator and implementation is underway.
- The 4 States namely, Jammu & Kashmir, Rajasthan, Mizoram and Nagaland, have initiated the bid process to identify the Network Operator for implementation.
- The 2 States namely Dadra & Nagar Haveli and Daman & Diu are in RFP/ BOM finalization stage.

Connectivity status of SWAN in 312 disaster Prone Districts

Network	Connectivity in disaster prone districts		
	P1(47)	P2(128)	P3(137)
SWAN (current status)	27	86	118

SWAN (status after 6 months)	10	20	15
Not connected to SWAN (till March 2010)	10	22	4

P- Priority, P1-High, P2-Medium, P-3 Low

In SWAN, there is provision of one video conferencing and equipment at SHQ and one at each DHQ, with call centre and Multi Conferencing Unit (MCU) located at SHQ. In SWAN there is provision for 10 VoIP phones at SHQ, 3 VoIP phones at each District and one VoIP phone at BHQ/THQ. This equipment can be utilized for NDCN in case of a disaster scenario. Desktop video conferencing can be installed at SEOCs and DEOCs.

In all the States, except Maharashtra, the bandwidth provider is BSNL. Barring few states like Maharashtra (only State in which BSNL is not the service provider), most of the states do not have any Service Level Agreement (SLA) with bandwidth service provider. Broadly, the SLA of minimum uptime with SWAN network operator is as given below:

S.No	Network Segment	Network Uptime (In %)	
		PBH	EBH
1.	SHQ	99.5	95
2.	DHQ	99	90
3.	THQ	95	85

3.2.6 Railway Communication Network

Indian Railways have an extensive connectivity network right from beginning for voice communication to facilitate train operations. With increased demand for a large number of such connectivity, the original analog

microwave systems were replaced with digital microwave systems for the major train routes. Subsequently, when IT systems were planned, it was decided to lay OFC as a backbone to meet the demand for bandwidth through a railway owned PSU, RAILTEL Corporation (established in September, 2000 to look after the backbone facilities) connecting 451 districts out of 626 districts through state-of-the-art dedicated 35000KM Fiber based broadband and multimedia network (using latest SDH/DWDM technology based transmission system and high-end MPLS-IP routers) laid along an exclusive Right of Way (RoW) along Railway tracks (this RoW being more secured and reliable RoW than any road based RoW which other service providers in the country use).

About 34000 kms of OFC (out of 62,800 kms of Railway Track passing through 7000 stations across the country) has been commissioned by RailTel, thus connecting over 3500 stations across India. RailTel is terminating 1 pair of fibers at every Railway station enroute which are spaced at 8-10kms to serve its parent organization. RailTel plans to lay over 49000 KM of fiber across Railway tracks, thus connecting over 5500 stations on its backbone by 2012.

RailTel has followed a layered approach in designing its network for efficient utilization and management of its network. Accordingly, RailTel has created three layers viz. Access Layer, Edge Layer & Backbone layer. Access layer provides minimum of STM-1 bandwidth at stations normally spaced at every 8-10 Kms. The traffic from access layer is aggregated on to the edge layer having STM-4 connectivity which is available in important locations at every 30-40

Kms, while the traffic from edge layer is finally aggregated on to the backbone layer available in big cities/towns located at every 60-70 Kms with STM-16 (2.5 Gbps) connectivity.

However, since most of the smaller stations did not fall on these cable routes, network connectivity is established by hiring links from other telecom service providers. At very remote locations, where commercial activities take place, connectivity is provided through V-sat links for which a railway owned HUB station has been established under the Freight Operations Information System (FOIS) with hiring of transponder services. These are being planned to be augmented by having some mobile V-sat units linked to Accident Relief Trains.

Backbone network has been configured in multiple 'self healing' ring architecture which provides for redundancy by automatically redirecting traffic away from failed/de-graded route for fault – free service. The complete network is managed by centralized network management system (NMS) located at New Delhi with back up at Secunderabad/Kolkata.

To provide whole range of VPN (like Layer 3 and Layer 2 VPN) and broadband internet access, multicast services, RailTel has implemented countrywide MPLS-IP backbone network using high end routers. MPLS network has POPs at 40 cities across the country and is in the process of being extended to other important cities/towns also. The IP services at more than 3000 POPs in the country will be extended through Ethernet interface available in the SDH networks at these locations. The MPLS NOC is also equipped with Dorado

Redcell and Infovista for network provisioning and performance management.

In addition to above, RailTel is also rolling out a broadband wireless access (BWA) network across India. BWA is a standards-based WiMax (Worldwide Interoperability of Microwave Access) technology for “last mile” solutions that can connect customers to the RailTel ISP/MPLS POPs through high-speed wireless access. RailTel has been allotted wireless frequency spectrum on 2.8 Ghz band across 43 cities.

3.2.7 BSNL Communication Network

Bharat Sanchar Nigam Ltd. (BSNL) formed in October, 2000, is a large Telecommunications Company providing comprehensive range of telecom services in India: Wireline, CDMA mobile, GSM Mobile, Internet, Broadband, Carrier service, MPLS-VPN, VSAT, VoIP services, IN Services etc. Presently, it is one of the largest & leading public sector units in India.

BSNL is the only service provider, making focused efforts and planned initiatives to bridge the Rural-Urban Digital Divide ICT sector with its wide network giving services in every nook & corner of country and operates across India except in Delhi & Mumbai

BSNL has set up a world class multi-gigabit, multi-protocol convergent IP infrastructure that provides convergent services like voice, data and video through the same Backbone and Broadband Access Network.

BSNL has installed Quality Telecom Network in the country and now focusing on improving it, expanding the network by introducing new telecom services with ICT applications in villages. The long distance

network consisting of more than 6 lakh kilometers of optical fiber communication covers a large segment optical fiber communication in the rural areas. With Dense Wave Division Multiplex (DWDM) technology extensively deployed, the optical fiber communication network provides huge bandwidth capacity in gigabits rate.

BSNL has wide area coverage of cellular mobile service and extensive connectivity provided through the wire-line network penetrating into rural areas. BSNL has already started offering 3G services to its mobile customers. As on 31st March, 2010, the wireless subscriber base has reached 69.45 million, which is 11.89% of total wireless market share. In wire-line segment, BSNL has the largest share with 27.83 million subscribers, which is 75.31 per cent of the total wire-line market.

Being an incumbent operator, BSNL has vast experience in planning, installation, network integration and Maintenance of Switching & Transmission Networks and also has a world class ISO 9000 certified Telecom Training Institute. Two typical satellite based networks which will be of special interest for DM activities, are described below:

(i) Digital Satellite Phone Terminal (DSPT) service of BSNL

BSNL has executed a Digital Satellite Phone Terminal (DSPT) project which involved setting up a VSAT based satellite network recently. The network provides PSTN connectivity to rural, remote, inaccessible and hilly areas. The VSAT system works in a star-topology using DAMA (Demand Assigned Multiple Access) technology.

The System provides two Way voice communications and also supports fax and voice band data. Each VSAT will be able to provide 2 voice channels and 1 data (internet) connection simultaneously. The source coding for voice shall be at 6.8 Kbps as per relevant ITU-T recommendations. The System consists of Hub Station and Remote Digital Satellite Phone Terminals working in Ku Band. The Transmit frequency is 13.75-14.5 Ghz and the Receive is 10.7-12.75 Ghz. The hub station uses a Ku band antenna of 8.1 meter and the DSPT uses a 1.2m antenna. This network has now over 6,000 terminals working and has given a major thrust to remote area communication.

(ii) Broadband VSAT service of BSNL

BSNL is operating INSAT based satellite network in Ku-band providing IP based always-on broadband service. This VSAT network of BSNL is capable of providing high speed data transfer up to 2Mbps (presently 512 Kbps) with 10/100 Mbps Base-T Ethernet Interface and voice communication service covering the entire country. The network supports all IPV4 protocols, offers Video Conferencing and Customer User Group (CUG) facility. Extensive Virtual Private Network can be created with MLLN (Managed Leased Line Network) nodes and MPLS nodes of BSNL

The network consists of a hub located at Bangalore and VSATs located throughout the country. The VSAT communicates to the HUB through Express AM1 Satellite. All VSATs are connected in STAR topology and VSAT to VSAT communication is through the HUB at Bangalore. The VSAT antenna is compact size measuring 1.2 metre diameter.

3.2.8 Power Grid Corporation of India (PGCIL) Network

PGCIL, a Navratna Company and Govt. of India Enterprise, has been contributing significantly towards development of Indian Power Sector. It is the central transmission utility and one of the largest Electric Power Transmission Utilities in the world with a vast network of more than 74000 circuit-kms of Transmission lines, wheeling 45% of India's total power generation.

Using its power transmission infrastructure to spread benefit of revolution in communication reaching across the length and breadth of the country, PGCIL has diversified into Telecom by establishing total 20000 Km of high capacity Optical Fiber Cable, out of which 15000 Km is over its transmission infrastructure (overhead) across the country. POWERTEL, the telecom arm of PGCIL has the unique distinction of being the only telecom player with a countrywide presence of optic fiber network, using overhead OPGW (Optical Ground Wire) technology.

Salient features of POWERTEL's Telecom Network are;

- Countrywide presence of OPGW network connecting over 120 cities.
- Connectivity to remotest, most difficult of terrains and far flung areas including North Eastern Region and State of Jammu & Kashmir.
- OPGW network is on its transmission lines (overhead) which are sturdy, secured, vandalism proof and all weather networks. OPGW does not require any routine maintenance, which is an essential criterion for

networks in such far flung areas.

- In case of disasters like earthquake, floods etc. power transmission is restored using Emergency Restoration System (ERS). Same benefit can also be availed in restoring communication network on OPGW.
- Entire network is monitored 24X7X365 and managed through Network Management Systems established at its National and Regional Control Centres.
- Trained and sufficient manpower to provide round the clock services and attend to the complaints.
- Can extend the OPGW network on its transmission lines to provide connectivity to the talukas & Panchayats falling within its corridors of transmission network.
- Can share its rugged and sturdy transmission tower infrastructure for installing GSM radio antennas to provide connectivity to district HQ/ Talukas & Panchayats falling within the corridor of 50 Kms of its transmission network.
- Gearing up to provide MPLS (Multi Protocol Label Switching) based services & Data Centres in near future.
- Range of services offered includes inter-alia, provisioning of leased circuits and IP leased circuits, Video Conferencing, VoIP etc.
- Hands on experience in dealing with emergency conditions, for example

Gujarat Earth quake or Tsunami to restore back power transmission.

3.2.9 Network of Department of Atomic Energy (DAE)

DAE has large number of R&D institutes engaged in exploitation of nuclear science and technology for various societal benefits along with a large number of major public sector undertaking, industrial units and aided institutes in its organization. For speedy and efficient functioning of these facilities, DAE has established a communication network, which essentially consists of three wide area networks (mentioned below) interconnected through a gateway

- (i) ANUNET set up and operated by DAE for various applications, including secure intercommunication of data, voice and video in addition to grid-computing, linking headquarters of all the units and also the aided institutes, and a number of other sites of DAE,
- (ii) NPCNET of Nuclear Power Corporation that has interconnected all its plants and project sites, and
- (iii) HWBNET Heavy Water Board (HWB) that has interconnected all its plants.

3.2.10 Common Services Center (CSC) Scheme

The CSC is a strategic cornerstone of the National e-Governance Plan (NeGP), approved by the Government in May 2006, as part of its commitment in the National Common Minimum Programme to introduce e-governance on a massive scale.

The CSCs would provide high quality and cost – effective video, voice and data content and services, in the areas of e- governance, education, health, telemedicine entertainment as well as other private services. A highlight of the CSCs is that it will offer web-enabled e-governance services in rural areas including application forms, certificates and utility payments such as electricity, telephone and water bills.

The Scheme creates a conducive environment for the private sector and NGOs to play an active role in implementation of the CSC Scheme there by becoming a partner of the government in development of rural India. The PPP (Public Private Partnership) model of the CSC scheme envisages a 3-tier structure consisting of the CSC operator (called Village level Entrepreneur or VLE) the Service Center Agency (SCA) that will be responsible for a division of 500-1000 CSCs and State Designated Agency (SDA) identified by the State Governments responsible for managing the implementation over the entire state.

The CSC network is the means of infrastructure that is being developed in the rural areas for delivery of citizen centric services and to reach out to the citizens. Various G2C services such as land records, electoral services, certificates, panchayat services, SSA, NRHM, NREGA, capturing of MIS are being offered through the CSCs. The NDMA can utilize the CSC network as Disaster Management and Mitigation Points for awareness building and media campaigning. The Campaign may include film shows, radio jingles, and awareness campaigns in pre-defined intervals. The CSCs

may target schools for audio-visual spots and short documentary films.

The CSC Scheme is being implemented in different States in a progressive manner. 90,018 CSCs have been rolled out in 30 States/UTs as on 28th February, 2011.

3.2.11 The National Knowledge Network

The National Knowledge Network (NKN) is being set-up in the country under 11th Plan to link more than 10,000 educational institutions and research organizations to facilitate sharing of knowledge and information through a very high bandwidth of 2.5 GBPS. This high speed information sharing digital network would remove the low bandwidth limitation of the present information highway, Garuda, that links scientific and research organizations and results in sharing of resources and undertake collaborative multi-disciplinary research amongst higher educational institutions in the country. Deploying thousands of kilometers of underground cables connecting major cities, towns and educational hubs, NKN will be similar to the model being operated by California Institute of Technology in the U.S.A. Currently seven IITs, BARC and two laboratories of the CSIR are planned to be connected, empowering thereby the student community to attend live classes at any educational institute of their choice. In view of the high spread and high bandwidth of this network, the National Knowledge Network, when implemented in the country, would be connected to the National Disaster Management Network of NDMA as an important network infrastructure for disaster management activities.

3.2.12 Emergency Planning and Response System, Ministry of Environment & Forest (MoE&F)

MoE&F has established a communication system called "GIS Based Emergency Planning and Response System for Major Cluster of Industries (GEPRES Ver-1.0)" developed to assist the various response agencies for planning emergency situation arising out of the spillage of hazardous chemicals in collaboration with Remote Sensing & Geographic Information System (RS & GIS) division of NIC.

All the Communication and IT networks, infrastructures, and the facilities already available, including those planned to be implemented in future, should be taken into consideration for appropriate integration in the National Disaster Communication Network (NDCN).

3.3 Existing Hazard Forecasting and Warning Network

Networks, which have already been established specially for hazard forecasting and warning, are indicated below:

3.3.1 Cyclone Forecasting and Warning Network

Presently Area Cyclone Warning Centers (ACWC) of the IMD generate special warning bulletins and transmit them every hour in the local languages through the network of 252 analogue receivers installed in the field. This analogue network of Cyclone Warning Dissemination System (CWDS) is planned to be replaced by Digital CWDS (DCWDS) receivers, along with additional number of DCWDS stations all along the east and west coasts of India. In

addition to the analogue network of 252 analog receivers distributed in the field, presently 101 DCWDS stations are also operational along the coast of Andhra Pradesh and one in Lakshadweep, making the total number of CWDS / DCWDS receivers in position to be 353 with uplink stations at Regional Meteorological Centre (RMC) Chennai and IMD at its Satellite Meteorological Division, New Delhi. Besides, IMD also uses other conventional modes of communication like telephone, FAX, radio and television for communicating warnings.

Information on cyclone warnings is furnished on a real-time basis to the Control Room set up in the Ministry of Agriculture, Government of India. High-power Cyclone Detection Radars (CDRs) that are installed along the coastal belt of India and Satellite imagery received from weather satellite are used in detecting the development and movement of Tropical Cyclones over oceanic regions.

Digital Cyclone Warning System developed by SAC, ISRO is DTH based Cyclone Warning and Dissemination system. The INSAT MSS type C Terminal (Hand-held type) receive Data based Cyclone warning and INSAT MSS type D Terminal (Hand-held type) receive Voice based Cyclone warning (on SCPC using DAMA).

3.3.2 Seismological Observations Network

Seismological observations in the country are made through a national network of Seismic Stations operated by the IMD, being the nodal agency. These stations have collected data over long periods of time, which can be effectively used for proactive Hazard Risk Analysis for mitigation effort.

3.3.3 Drought Warning Network

The National Agricultural Drought Assessment and Management System (NADAMS) has been developed by the Department of Space for the Department of Agriculture and Cooperation. The drought assessment is based on a comparative evaluation of satellite observed green vegetation cover (both area and greenness) of a district in any specific time period, with that of any similar period in previous years.

3.3.4 Flood forecasting and Warning Network

Floods, heavy or catastrophic ones, are bound to occur periodically. They cannot be prevented or controlled. Embankments and big dams moderate floods to some extent, but may themselves cause problems if water has to be released in the interest of the safety of structures. Increasing green cover in the catchment area, extensive water harvesting, groundwater recharging, and so on, may perhaps slightly reduce the incidence of floods. However, floods will occur from time to time, and we have to learn to live with them, minimize harm and damage and maximize benefits.

Flood forecasts help in optimum regulations of multipurpose reservoirs with or without flood cushions in them. This service has been rendered by Central Water Commission (CWC) to cover almost all major flood prone inter-State river basins of India. CWC operates a Nation Wide Network of 945 hydrological observation stations distributed in various river basins. At present, there are 145 level forecasting stations on major rivers and 27 inflow forecasting stations on major dams/

barrages. It covers 9 major river systems in the country, including 65 river sub-basins pertaining to 15 hazard prone states. Normally forecasts are issued 12 to 48 hours in advance, depending upon the river terrain, the location of the flood forecasting sites and base stations. The Flood Forecasting and Warning network of the CWC is mostly based on hydro-meteorological data recorded by observers and communicated by wireless and/or telephone. Very few river basins have been covered with automatic sensors for observations and telemetry system for communication of data.

To overcome the limitations of existing system, the CWC has undertaken various expansion and modernisation schemes to cover more areas and to make forecasting more efficient and reliable. The IMD has also taken up the expansion of its network of Automatic Rain Gauges. The Ministry of Earth Sciences (MOES) is making efforts for the procurement of 12 Doppler Weather Radars (DWRs) for continuous monitoring of evolving extreme weather phenomena including heavy rainfall events along the coastal areas apart from tracking cyclones. Gradually, the DWR network would cover the whole country and in the process all the major river basins as well.

Hydrological data from various river basins that are collected by IMD, CWC, and State Governments (collected by using Bureau of Indian Standards approved automatic sensors for rainfall and river flow measurements) are planned to be stored in centralised mechanism for distribution and archival. Similarly, Computer-based comprehensive catchment scale hydrological and hydrodynamic

models, interfaced with flood plain inundation mapping tools, will be developed. Forecast will be disseminated using computer networks and satellite (e.g. Internet, e-mail, VSAT), the terrestrial communication network connectivity of the National Informatics Centre (NIC) etc.

The efforts of CWC, IMD, NRSA and State Governments will be integrated and a mechanism developed wherein during monsoon, the representatives of all these organisations and the basin states work together in formulation and dissemination of reliable forecast and warning.

3.3.5 Tsunami Warning Network

Consequent to the devastating tsunami on December 26, 2004, (that was triggered by an under-ocean EQ off Sumatra-Indonesia with magnitude of 9.1 Mw, leading to the death of more than 2,30,000 people that include about 10,000 from India), the Regional Tsunami Warning Centre (RTWC) has been set up at Indian National Centre for Ocean Information Services (INCOIS), Hyderabad. This national early warning system for tsunami and storm surges in Indian Ocean has become operational since December, 2007. Essentially this centre receives on 24X7 basis real-time seismic data from the network of 17 broadband seismic stations of India Meteorological Department (IMD) as well as near-real-time data from International Seismic Networks of Japan Meteorological Agency, Pacific Tsunami Warning Centre (PTWC) and Global Seismographic Network (GSN) of 200 active stations belonging to Incorporated Research Institute for Seismology (IRIS-200), USA, to detect all earthquakes with moment magnitude greater than six ($M_w > 6$) in Indian

ocean within 8-15 minutes of their occurrence. IMD network provides signals through VSAT and International networks send the signals through Internet/Emails.

Indian tsunami warning system operates using 3 tiers viz; 'watch', 'alert' and 'warning' depending on size and continuity of waves detected. For areas close to the earthquake source (e.g. Andaman and Nicobar Island) and south-west coast of Indian Ocean, Tsunami Early Warning is sent within 5 to 10 minutes based solely on earthquake information. However, for areas far from earthquake sources, a Watch-Signal is initially generated based on earthquake data, which is subsequently upgraded to a Warning-Signal, if tsunami generation is confirmed from Bottom Pressure Recorders (BPR) as well as Tidal Gauge Signals – otherwise the Watch-Signal is cancelled.

BPR consists of a sub-assembly of piezo-electric crystal and a companion moored surface-buoy linked with two-way acoustic transducers. Any significant changes in sea level due to tsunami is monitored by 12 BPRs (10 in Bay of Bengal and 2 in Arabian Sea) and wave heights are measured by 50 Tidal Gauges (36 installed by SOI and 14 by The National Institute of Ocean Technology (NIOT)). These are installed at all strategic locations to serve the purpose of generating EW signals. The sensors are based on sub-sea transducers equipped with highly accurate piezo-electric pressure gauges (that are positioned at sea-bed hundreds of miles off the Indian Coast), that transmits an acoustic signal (if there is small but continuous change in water level) to a radio-buoy moored with (attached with) the anchor of the BPR. Real-time

data from all these buoys are received at INCOIS through VSAT (using VHF-radio frequency via both INSAT3A and KALPANA simultaneously) while the data from NOAA-BPRs (2 nos located in India Ocean) are also received at INCOIS through Internet (E-mail) with a delay of about 15 minutes.

Five Coastal observation Radars (HF-Radio Frequency based) and two Current Meter Moorings are installed to monitor Storm surges and physical behaviour of the ocean.

The custom-build application software necessary for continuous monitoring of the seismic and sea-level-change data has been developed by INCOIS in collaboration with NIOT (for Tsunami modeling) and TCS (for post processing and display) to trigger an alarm, whenever a pre-set threshold is exceeded for further dissemination of the alert to the stakeholders. INCOIS issues confirmed alert within 30 minutes of earthquake. The Warning-Signal provides travel time, surge height at the land-fall point and the extent of inundation.

3.3.6 INSAT Based Distress Alert Transmitter for Fishing Boats

Indian Space Research Organization (ISRO) has developed INSAT based Distress Alert transmitter (DAT) through an Indian industry with technical expertise from Space Applications Centre (SAC), Ahmadabad. The requirement for a satellite based Distress Alert Transmitter was given by the Indian Coast Guards, for use in fishing boats going deep in to sea. In case of emergency, the fishing boat transmits a short message containing its position and type of emergency to a central location through satellite for rescue operation. The transmitter operates

through DRT Transponder of INSAT-3A in the frequency band of 402.65 to 402.85Mhz

The transmitter has following features:

- It is light weight, portable, floatable and battery operated transmitter suitable for marine environment
- Low cost affordable by fisherman
- Inbuilt GPS receiver to give position and time information
- In the event of emergency the user manually activates the transmitter and press a switch indicating emergency condition to relay the message to a Central Station through INSAT satellite, the function is similar to PLB (Personal locator Beacon)
- Transmits different types of emergency like fire, boat sinking, man overboard or medical help on manual activation
- Test transmission facility
- Once activated, transmits in random mode, every 1- minute for 5 minutes and then once every 5 minutes. Transmission lasts for 24 hrs.
- Uses Omni directional antenna having hemi spherical coverage, suitable for operation from fishing boat
- Uses lithium primary battery (7.2V/3.2 Ah)

3.3.7 VHF Radio Communication System for Fishermen Community in Tamil Nadu

Tamil Nadu Government's scheme of establishing a communication network, under Tsunami Project Implementation, for the entire coastal region of Tamil Nadu, which has a

length of 1076 km, has been approved by the Planning Commission, Government of India. The Government in principle has agreed for a pilot project in Ramanathapuram District with the objective to study the provision of voice communication for small craft and voice and data communication for mechanized crafts of the fishing community.

Accordingly it is planned to establish a VHF network, which will provide marine radio VHF sets to fishing crafts to establish voice calls between the crafts and send their L/L (Latitude/ Longitude) position data to the shore station using an external GPS receiver or internal to the set at normal times and at times of crises. The VHF system will comprise of Shore station, Fixed mount radios on trawler boats and Portable radios. The approximate aerial coverage will be 40-50 kms into the seas. The scientific data on fish catches collected by INCOIS with Geo-coordinates can be broadcast to fishermen at regular intervals. Weather forecast on impending cyclone or depression or even Tsunami warnings can be sent in the best possible manner using the radio system. A web based vehicle tracking software has been included to track the trawlers with the help of the GPS enabled broadcast from the Fixed Mount Radios to the shore station.

3.3.8 Decentralized DM Information Network, Jadavpur University

Centre for Distributed Computing Jadavpur University in collaboration with IIM, Calcutta initiated a project titled "A Secured Decentralised Disaster Management Information Network using rapidly deployable wireless network & mobile computing technologies". This project is funded by Department of IT, Min. of

Communications and IT, Govt. of India. Two of the major objectives of the project are as given below.

- To design and develop a Secure Decentralized Disaster Management Information Network (SDDMIN) architecture consisting of Fixed and Mobile wireless equipment.
- Addressing the on-line, decentralized, internet based disaster communication system using wireless and mobile technologies.

3.4 Communication Modes Available for Disaster Forecasting and Warning

Keeping in mind the time – sensitivity and volume of data transfer needed for effective and reliable communication to the right stakeholder at the right time, various technological options would be adopted in NDCN during various phase of DM. However, for ensuring the EW and Forecasting of disasters reach the community in the likely affected area, all the technological options available with public and private ICT operators, including the services of individual members/NGOs are to be pressed into service so that the prime DM objective of eliminating/ minimizing the loss of life is achieved.

Various technological options that are available for the purpose of DM in general and for Early Warning & Forecasting of natural hazards in particular are briefed hereunder with their relative merits and demerits. These communication media – both traditional and new can be effectively used for the common goal of passing along disaster warnings as

quickly and as accurately as possible, either alone or in combination.

Some options may be more effective than the rest, depending on the nature of the disaster, the regions affected and the socio-economic status of the affected communities. Needless to say that NDCN would fall back on the terrestrial and wireless technologies for assured last-mile connectivity during various phases of DM continuum.

Communication media, which in general enable Early Warning Dissemination are Radio and Television, Telephone, Public Address Systems of Civil Defence, Email/Internet, cell broadcasting, Amateur Radio, Satellite communications etc. These are discussed in detail in the following paragraphs

(i) Radio and Television

Considered the most traditional electronic media used for disaster warning, the effectiveness of radio and television media is high because they can be used to spread a warning quickly in an easily understandable and local language based early warning to a large population even in an environment where the tele-density is relatively low. The only possible drawback of these two media is that their effectiveness is significantly reduced at night, when they are normally switched off.

After the Indian Ocean tsunami of 2004, many radio manufacturers are considering to introduce new digital radio alert systems that would trigger even if the set is switched off. In order to activate the alarm, a special signal sent through a terrestrial transmitter or a satellite would be used to automatically tune to an

emergency broadcast channel (in case of digital receivers, this would be somewhat easier).

(ii) Telephone (Fixed and Mobile)

Telephones can play an important role in sending early warning to the communities about the impending danger of a disaster that can save many lives. A timely telephone call from a person (belonging to Nallavada village in Pondicherry who was at that time working in Singapore), warning about the impending tsunami had saved the entire population of 3,600 inhabitants of the village, as well as those of three neighboring villages, before the tsunami could hit the coast.

Effectiveness of telephone call can be enhanced by a mechanism called 'telephone trees' to warn communities of impending dangers. When an individual receives a warning message (either through phone or by other means), he/she is supposed to make a pre-determined number of phone calls (usually four or five) to others in a pre-prepared list. This arrangement not only ensures the timely delivery of the warning message, but also ensures the minimum duplication of efforts.

However, there are two drawbacks to using telephones for disaster warning. Telephone penetration particularly in rural and coastal areas is far from satisfactory. The other drawback is the congestion of phone lines that usually occurs immediately before and during a disaster, resulting in many phone calls in that vital period not being materialized through.

(iii) Short Message Service/ Cell Broadcasting

Short message service (SMS) is a service available on most digital mobile phones that

permits the sending of short messages between mobile phones, other handheld devices and even landline telephones. There are instances when many residents of affected coastal areas are unable to make contact with relatives and friends using traditional landline phones, but could easily communicate with each other through SMS as long as the network is functional. This is because SMS works on a different channel and can be sent or received even when phone lines are congested. SMS also has another advantage over voice calls is that one message can be sent to a group simultaneously.

Most of today's wireless systems (based on CDMA and GSM technologies) support a feature called cell broadcasting, through which a public warning message in text can be sent to the screens of all mobile devices operating in any group of cells of any size, ranging from one single cell (about 8 kilometers across) to the whole country.

Some of the important advantages of cell broadcasting for emergency purposes are:

- There is no additional cost to implement cell broadcasting. There is no need to build any new towers, lay any cable, write any software or replace handsets.
- It is not affected by traffic load; therefore, it will be of use during a disaster, when load spikes tend to crash networks.
- Cell broadcasting is geo-scalable, so a message can reach hundreds of millions of people across continents within a minute.

The only possible disadvantage to SMS/cell broadcasting is that not every user may be able to read a text message when they receive it, unless the warning messages are sent in local languages. Further, these messages would still be inaccessible to those who cannot read, even in their own language.

(iv) Internet/Email

The Internet is a global network of networks enabling computers of all kinds to directly and transparently communicate and share services in most of the world. The internet provides a new, potentially revolutionary, rapid and very cost-effective means of making an intra-national and international disaster warning communications. The Internet, while broadly available, has no timeline guarantee and is subjected to congestion and disruption. In spite of this drawback, many disaster-related activities are already underway within the Internet community. The role Internet, email and instant messages can play in disaster warning entirely depends on their penetration within a community and the extent of usage by professionals such as first responders, other stakeholders, etc.

(iv) Intranet/VPN

An intranet is a segregated community of network nodes with strictly controlled access, typically managed by a single organization. Access to and from the external Internet is provided through password, security firewalls etc. It may also be called a virtual private network (VPN). Since users are all from one entity, large traffic peaks can be identified and controlled more easily and messages can flow without the fear of congestion.

(v) Amateur Radio

For almost a century, amateur radio (also known as ‘ham radio’) operators have assisted their communities/countries during disasters by providing reliable communications to disaster relief organizations at a moment’s notice – especially when traditional communications infrastructure breaks down, by transmitting emergency messages on voice mode about the well-being of survivors and information on casualties to friends and relatives. As was evident during the Indian Ocean tsunami that destroyed electricity and communications infrastructure in the Andaman and Nicobar Islands, amateur radio operators were the critical link between the islands and the Indian mainland and helped in the coordination of rescue and relief operations.

Some amateur radio operators can also transmit in digital modes (for radio teletype, tele-printing over radio, packet radio transmission etc), in addition to disseminating voice-based messages

Amateur radio broadcasters are authorized to communicate on high frequency (HF), very high frequency (VHF), ultra high frequency (UHF) and even satellite bands of the radio spectrum. HF waves travel long distances, while VHF and UHF waves travel very short distances as these are line-of-sight propagation. However, repeaters increase the communications range and temporary repeaters can be set up in an emergency so that messages can reach the nearest town or city.

(vii) Community Radio

Even though there are not many cases where community radio has been successfully

used for disaster warning purposes, it still is a medium that can be very effectively used for disaster warning purposes. The effectiveness of this medium is being established through a disaster warning system implemented by INCOIS.

(viii) Sirens

Though not necessarily an ICT-based solution, sirens can be used in tandem with other ICT media for final, localized delivery. In the neighbouring Bangladesh in the early 1970s, a cyclone killed more than 300,000 people. However, after the country put in the extensive early warning system, a recent cyclone of similar intensity took 3,000 and not 300,000, lives.

3.5 Other ICT based Initiatives (IRDN,NANADISK,NDEM)

A number of ICT based initiatives, and application tools, which have been planned/ developed to help the disaster managers through their dissemination using various networks, are furnished below.

- (a) Indian Disaster Resource Network (IDRN), a web based on-line information system, (ie. www.idrn.gov.in) has been established under the Disaster Risk Management Programme of UNDP. The Network acts as a disaster resource inventory containing comprehensive database of material and human resources available and their locations, to respond to emergencies on an immediate basis. However, it needs to be updated on a regular basis.
- (b) National Disaster Knowledge Network (NANADISK) was planned as a “Network

of Networks” linking important libraries, institutions engaged in disaster risk reduction, and Indian and global data bases. The Network aimed to create public awareness through knowledge, establish knowledge based enterprises and facilitate training programmes through cyber space (the Network, which promises great potential, has not yet been established).

- (c) GIS-based National Database for Emergency Management (NDEM) has been established by MHA through NRSC in collaboration with various Ministries/agencies to have the communication links between decision makers at various levels and response teams/personnel at the disaster affected site.

3.6 Limitations in Existing Communication and ICT Support

There are several communication and IT related networks operational both in public and private domain, but they are all operating in a ‘Stand Alone’ mode and need to be integrated appropriately. For example, existing police network operates as Intranet without providing any accessibility to a citizen into this captive network, even through such accessibility is essential during disaster situations. Need of the hour is to connect them to a common network (though appropriate routers / gateways in EOCs at different levels of administration) which can be utilised as per bandwidth needed for disaster management riding on the existing infrastructure itself.

Existing Service Providers’ network are mostly based on terrestrial communication which, are invariably inadequate in their design to withstand earthquake, wind forces, or not located at safe heights to avoid damage due to floods. As a result, the network is vulnerable for break down at the time of disaster. Hence, satellite connectivity as alternative, which provides failsafe communication during disaster, is essential

Since the basic criteria should be to optimally utilize the existing Communication and IT Infrastructure in the Country while creating National Communication and IT Network, the existing Infrastructure, when viewed in the light of the overall Communication and IT requirements for DM, brings out number of limitations, shortcoming and gaps. These are explained in the succeeding paragraphs under various categories.

3.6.1 NECP 2004 Plan

- i) This Plan is basically relief centric in nature as against the requirement of it being a proactive, responsive and integrated network.
- ii) The POLNET does not provide the required bandwidth and capacity. It needs major upgradation.
- iii) POLNET operates in C-band, whereas highly compact and portable satellite terminals are available in Ku-band
- iv) The Plan is Voice centric with limited Data handling capabilities.
- v) The ‘Communication Set’ planned to be provided to each NDRF Battalion for setting up Mobile Emergency Operation Centre (MEOC) at the

disaster site needs to be suitably augmented and grouped with each NDRF Battalion for movement, deployment and operation.

3.6.2 Emergency Operations Centres (EOCs)

As per the “National Disaster Management Policy”, EOCs are required to be established at the National, State, and District levels and at the disaster site. The present status with regard to these is as under:

- (i) At MHA, NEOC-I has been established but with limited connectivity.
- (ii) A command and control center is to be established at NDMA, which would be finally linked to NEOC –II planned to be established at a different location.
- (iii) As regards States and Districts, EOCs have been established in a few States and Districts but with limited connectivity and capabilities.
- (iv) Mobile EOCs, which are planned to be established at the disaster site at the time of disaster are yet to be equipped with the required Communication and IT resources.

3.6.3 Specific Disaster Related Issues

- (i) As part of effective DMIS, Data Fusion at National level along with GIS based applications is of paramount importance. Presently no effective Data Fusion Centre has been established. Even the Data Centres established in a few States and Districts have limited functional capabilities, as the Data available is mostly generic in nature and not disaster specific.

- (ii) The present availability of last mile connectivity (LMC), especially for the affected community and disaster managers, is inadequate. In addition, very limited provisions exist for providing effective emergency communications to the affected community at the time of disaster.
- (iii) During disaster situations, adequate provisions for interaction with the media are not available.
- (iv) There are no institutionalized arrangements for setting up ‘Help Lines’ at various levels, at the time of disaster. This is extremely important in today’s context of active media involvement during such contingencies
- (v) Though a number of disaster related Websites have been established at National and State levels, these are not interactive in nature. Additionally, all State level Web-sites need to be multi-lingual.

3.7 Limitations of Existing Application Development

There exists serious shortcomings with the development of various application softwares needed for holistic DM. Some of these deficiencies are highlighted below:

- i) Absence of reliable data, of uniform quality in a usable format: One important development needed will be to establish ‘level of reliability’ of the data in order to define what margin of error is tolerable for what type of information.

- ii) Lack of reliable historical records of past disaster events: It makes hazard mapping difficult to undertake with any degree of confidence.
- iii) Absence of reliable social and economic data: It does not permit proper analysis on vulnerability.
- iv) Lack of reliable damage data: The officials who collect vital post disaster information tend to have a restricted time frame for such data. Since the post disaster information plays an important role for incorporating improvements in overall planning system, proper collection and compilation of damage data is most important.
- v) Lack of interactive relationship between the end users and the developers: Interactive relationship is required throughout the application development lifecycle. The present application development is mostly driven by software professionals and the involvement of the end users is only during crisis situations.
- vi) Lack of coordination between the developer and the end users: It is essential to build ICT based solutions to disaster management.
- vii) Lack of involvement of domain experts: Application development/ implementation requires software skills as well as domain expertise. The domain experts (end users) have very limited involvement in developing the solution and this may be one reason for slow progress of the developmental/ implementation work.
- viii) Loose coupling of application modules: The development of all the application modules is over a period of time using various technologies and different Operating Systems. Hence, these modules are loosely coupled.
- ix) Absence of the state of the art emergency communication network, computer hardware and skilled personnel for implementation of the project.

3.8 Action points

- (i) Utilisation of the existing service providers for telecommunication network for bandwidth provisioning in NDCN. Further, alternative satellite back-up network, which provides fail-safe character, must be included in NDCN network architecture to avoid communication breakdown in the case of any disruption in any of the existing service provider's network.
- (ii) Strengthening of communication infrastructure for NDRF Battalions.
- (iii) Interconnection of POLNET, NICNET, DMS & SWAN with NDCN.
- (iv) Adoption of GIS platform and Decision Support System for holistic management.
- (v) Speedy establishment of SWANs in the remaining States where this is not functional.
- (vi) Ensuring interactive relationship is required between the software professionals and end users throughout the application deployment lifecycle.

4

Need for GIS-Based National Disaster Management Information System

4.1 Introduction

As we have discussed earlier, S&T driven knowledge-based information infrastructure is essential to provide a balanced support to all the phases of DM to ensure sustainability of nation's development effort. Investment in prevention, mitigation and preparedness are now accepted world over much more cost effective than expenditure on relief and rehabilitation.

Unlike man-made disasters, natural ones cannot be prevented at the present level of science and technology. However, the impact of the natural disasters in terms of loss of life, property and damage to the environment can be minimized by appropriate mitigation and preparedness plans, commensurate with the level of resources and technologies available.

To arrive at the level of acceptable risk, level of mitigations and preparedness programmes are to be based on (i) the level of protection targeted (e.g protection of lifeline resources /infrastructures calls for enhanced level of protection to ensure that these vital resources/infrastructures would survive the worst possible hazard impact) and (ii) the level of S&T base along the level of mitigation resources that can be mobilized.

Acceptable risk has to be progressively minimized as we advance in our S&T base for better understanding of the disasters on one hand and make available resources for induction, particularly in the pre-disaster scenarios, on the other hand.

4.2. Knowledge-based Tools for Holistic DM

Over the past decade, revolutionary advances in computational capability offering large storage capacity at affordable cost and the advances in the communication and meteorological capability of INSAT system is being operationally used towards tracking, monitoring and prediction of cyclones. Application of these advances reflected in the recent achievements include inundation mapping of all the major floods in the country, drought severity assessment using satellite data on fortnightly / monthly time scales, landslide zonation of pilgrimage routes in Himalayas, monitoring of cyclones and damage assessment. The capability of Global Positioning System (GPS) to precisely determine the position of a location is being used to measure ground movements associated with plate tectonics.

In order to move towards holistic DM in the country, there is therefore, a need to induct advanced S&T in DM for developing wide ranging knowledge-based tools that are essential for the most efficient, fast and cost-effective DM in holistic manner covering all the phases of disaster continuum.

Each phase, however, depends not only on the same knowledge-base but also on another phase to deliver the needed baseline data and value-added information.

4.2.1 Development of Vulnerability Analysis and Risk Assessment Tools

The single most important scientific tool that needs to be deployed is the “Vulnerability Analysis and Risk Assessment” (VA&RA) of the people, the habitats and the infrastructures in different parts of the country with respect to various natural hazards for empowering the stakeholders at all levels of administration.

Centered around two parameters, viz: the demand for survival of the buildings / infrastructures against the hazard profiles (i.e. the damaging forces) and their physical capacity to withstand the same, **VA&RA involves estimation of the probability for five different damage patterns** (nil, slight, moderate, extensive and complete).

The damages so arrived at are then converted to economic losses and human casualties (in terms of different types of injuries) by using mathematical models. With S&T based tool of Vulnerability Analysis, it would be possible to construct models that predict the impact of a given disaster event in a specific time/place. For Risk Assessment/Loss Estimation, usually, such analysis starts with preparation of a

“technical template” by experts, classifying the buildings/infrastructures into certain categories of buildings/infrastructure (Typologies of Building/Infrastructure) that would be amenable to evaluation of their damage patterns due to different hazards at various magnitudes.

The powerful VA&RA tool, would enable DM Stakeholders to avoid adhoc decisions by way of identifying and prioritizing the following (as per Vulnerability Profile) :

- all mitigation tasks/projects;
- rationalizing programmes on preparedness & capacity development work;
- **adaptation of appropriate rehabilitation and reconstruction work, including retro-fitting of life-line and heritage buildings, major schools and other important community structures;**
- enforcement of building construction codes;(specifically while dealing with earth quake hazard)
- planning for future land-use to minimize/eliminate unnecessary construction costs for new buildings/infrastructures;
- designing of underground lifeline infrastructures like tunnels, water & sewage lines, gas & oil lines, power & communication lines etc;
- decision on location of NDRF battalions & their training centers, DM resource centers, shelters, relief centres, medical facilities etc

While on the subject, it should be remembered that, following a major disaster, it

is essential to review Vulnerability Analysis and Risk Assessment data for the hazard, **since the event may have significantly changed the hazard map, originally considered.** A disaster event may expose the inadequacy of our mitigation measures or the extent of our preparedness. These deficiencies need to be studied through expert analysis of the data on damage-pattern-survey and actions for improvements to be introduced.

4.2.2 Development of Decision Support System (DSS) in Virtual Environment

Like VA&RA tool for pre-event scenario, there are a host of other equally important DSS tools (needed during-and post-event scenarios) and computer based Virtual Environment (that are most effective tool for testing preparedness programme)

Timely information in the location, progression and regression of disasters at various phases of the disaster depicted in a dynamic map is essential towards effective management of the disasters and this can be generated in Geographic Information System (GIS) linked with Global Positioning System (GPS) , derived by integrating the real-time space-based imageries of the hazards with the corresponding ground information.

Whenever a flood / cyclone threat is sounded, necessary actions should be initiated to minimize the impact for which scientific inputs, in the form of knowledge-based DSS, should be made available in a ready to use format to the district officials.

The primary information should be on the likely impact of the event in terms of the extent

of the area affected, location specific details, population affected, availability of resources for evacuation of the people & relief and quick assessment of damages.

GIS-platform allows **easy visualization of the dynamics of the disaster w.r.t. time and prepares appropriate action plans for rescue and relief and post – disaster scenario** that can be transmitted to various stakeholders (viz incident commanders at Emergency Operating Centers (EOCs) as well as the disaster response personnel) for quick and efficient implementation with excellent coordination. For example instead of cyclone forecast in terms of time and space or flood forecast in terms of rainfall data/ rise in water level, it would be most desired and effective, if the initiation, progression and recession scenarios could be customized in terms of area of cyclone / flood influenced and likely damages to the infrastructure) expected. Such analysis could identify areas that should be rezoned or regulated because of their susceptibility to different disaster types.

There is an obvious advantage of using a map with remote sensing or GIS inputs instead of a static geographical map. A static map is mostly analogous and is not interactive. On the other hand, a hazard map with GIS input provides dynamic information with cause and effect relationship.

GIS can support better planning for response in terms of evacuation routes, location of vital lifelines like locations of fire stations, medical/paramedical units, relief materials, shelters, airports, railways and ports etc.

Creation of the NDMIS for such DSSs calls for:

- modeling and simulation capabilities, data visualization and integration tools (particularly those supporting management of geospatial data/objects),
- advanced data mining and core sampling applications,
- rapid damage assessment tools,
- logistics planning tools,
- collaboration technologies supporting real-time dissemination in distributed environments, and
- enabling technologies and methodologies supporting virtual expert forums.

At present, tested and validated models for operational use for assessing and estimating various parameters required for disaster management such as earthquake prediction, landslide prediction, accurate prediction of cyclone track and landfall in space and time domain, flash flood forecasting, spatial inundation simulation, models for detailed damage assessment etc., are not available. Hence, research efforts and academic interface is required for continuous improvement in adopting suitable, accurate and appropriate models.

Similarly, most of the disasters having their own specific characteristics, the availability of a computerized virtual environment would provide, in the pre-event scenario, a simulation system for testing disaster preparedness in a computerised environment. It would increase the possibility to test under different scenarios and establish the required changes in the response repeatedly with a large number of variables of

the preparedness in a limited amount of time and with a very minimal cost.

In absence of such simulated testing, the other way is to test the preparedness in full scale mock drills or disaster exercises. However, these must be planned, executed and evaluated very meticulously in order to be extensive enough for all preparedness facets and functions to be tested.

4.3 Rationale for Establishment of NDMIS

In the light of essential need of DM tools like VA & RA and DSS described earlier (instead of relying only on voice, data or video), there is, an immediate need to create National Disaster Management Information System (NDMIS) at NDMA to provide the necessary knowledge-based information to be established on GIS platform. NDMIS can be loosely defined as a system of hardware and software that are used for collection, storage, retrieval, mapping and analysis of geographic, demographic, topographic, infrastructure details, socio-economic data etc of the entire country. These data are superimposed on digitized base-map (prepared at the appropriate scales with required contour intervals) and the hazards profile data (in conjunction with satellite imageries) to generate knowledge-based information (i) like VA&RA tool, computerised virtual environment for their utilization in the pre-event scenarios (ii) and Decision Support Systems (DSSs), that are most effective empowering tools for during-and post-event scenarios.

S&T based DM tools referred to are to be developed by involvement of the domain experts and software specialists and then, be made

available in various servers hosting disaster specific data that can be accessed during any phase of the disaster continuum with proper authorization and authentication. As these tools are essential to move away from response-centric to holistic DM, such DM tools are also must for all Incident Command and Controls (at different levels through EOCs).

At the ground level, creation of NDMIS involves establishing the necessary computational and data handling hardware along with necessary software, for development of various applications on the GIS-platform for the hazard profile to empower the stakeholders (during pre - during and post - disaster scenarios).

Data acquisition and management will follow Hybrid approach i.e. Top Down for Fused Data and Bottom Up for Basic Data.

The complete information system shall, be composed of three essential elements viz:

- Knowledge based information
- Integration of current sources of data and information
- Interconnectivity for dissemination of these data/information sources to the stakeholders

Information assurance must be maintained across an open, but restricted level for processing and transmission only after proper authentication and authorization. For effectiveness, coordination to ensure timely information delivery is critical in all phases of DM cycle.

NDMIS is like a suite case where data and the information are protected from unauthorized

access or accidental corruption or loss of data/information due to hardware (power outages/ computer crashes) or software (OS crashes) failures. It allows concurrent access (i.e., same data can be accessed by more than one user at a time like the airlines reservation system which is accessible to many travel agents simultaneously).

No single source of information meets the demand of disaster managers. However, individual images or elements of information often become much more meaningful when carefully combined with complementary data. The fusion of various disparate data / information can provide the disaster managers with decisions / DSS by way of a dynamic Mapping system (superimposed on GIS Platform) that are most meaningful and effective tool for DM.

Presently, some of the knowledge-base is available in the country in some public and private archives that are best suited to its own disaster management. However, the value for organizing the virtual knowledge-base to benefit all the stakeholders working in all phases provides the necessity to integrate all the available information and or create information for all phases of disaster management.

Based on the functions of the providers, disseminators & users and disaster type (different types of natural as well as man-made) as well as the requirement in various disaster phases (pre, during, post), all the current sources of information are to be integrated and these sources of information are to be disseminated through assured connectivity to the disaster managers at all levels.

The value for organizing a knowledge-base (that benefits all the stakeholders working in all phases) drives the necessity to integrate all the available information and/or create information for all phases of disaster management.

While it is true that information alone will not solve all problems, effective information exchange between the stakeholders will enormously improve national effort for emergency preparedness & response. In fact, without knowledge-based information, we cannot move away from erstwhile response centric DM to a holistic one.

As disaster management work usually involves a large number of different agencies working in different areas, the need for detailed geographical information in order to make critical decisions is high. By utilizing a GIS, the stakeholders involved in the DM cycle can share information through databases on computer-generated maps in one centralized location. Without this capability, disaster management workers have to access a number of department managers, their unique maps and their unique data. Most disasters do not allow time to gather these resources. GIS, thus, provides a mechanism to centralize and visually display critical information during an emergency.

This is the rationale to develop NDMIS at NDMA where the disaster data collected from different nodal agencies will be utilized along with detailed Geographic Information System (GIS) for generation of very sophisticated actionable information for all the stakeholders at various levels of administration, by involving

the domain experts from the S&T community of the nation.

4.4 Development of NDMIS

The development of NDMIS, however, calls for availability of the following set of technical inputs viz:

- (i) Digital Cartographic Base at the appropriate scales and contour intervals;
- (ii) The upgraded hazard maps of India with respect to various natural hazards (in term of locations, frequency, duration and intensity);
- (iii) GIS – database linked with GPS.

A brief detail of the GIS-Data base is discussed further.

4.4.1 GIS-Database

For hazard/emergency management, the data requirements can be grouped into two categories i.e. core data sets and hazard specific geospatial data. Geospatial data requirements for DM can be grouped into two categories i.e. core data sets and hazard specific data, (to be accessed from diverse sources and brought to a common platform with well defined standards and appropriate format) along with dynamic data in spatial as well as non-spatial forms. The spatial data are to be linked with corresponding non-spatial information such as socio-economic and infrastructure to enable decision making process more efficient and objective.

- Core data sets are those which are commonly required for management of all disasters (e.g. topographical,

hydrological, socio-economic, infrastructural details etc)

- The hazard specific geospatial data sets are the particular hazard/emergency like cyclone, flood, landslide, earthquake, fire, structural collapse etc. (figure-1 below)

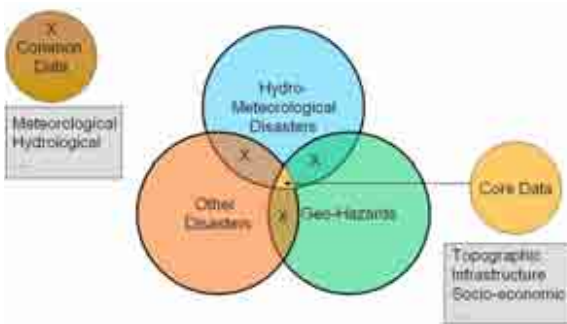

Figure-1. Core and hazard specific data sets

For the development of a multi-layered GIS for Disaster Management, the main components of GIS are Input Maps (Survey of India topographical sheets, Soil taxonomy map etc.), GPS enabled Field Data and Satellite Data (Indian Remote Sensing (IRS) data). All spatially referred (i.e linked to a location) data are modeled either as Vector data model (for discrete features) or Raster data model (for continuous features) for their use in GIS software.

In addition, issues like uniformity and standardization of the data, appropriateness and quality of the data and need for conversion as well as organization of data base in Relational Database Management System (RDBMS), digitization of input maps, attribute attachment, layer formation and development of digital base map would be some of the major tasks.

Every user of GIS today utilizes most, if not all, of the following three types of data that constitutes a GIS-platform and these three are used at varying levels in all GIS applications, including those deployed in EOCs.

- i) The Geo-database view: It is a view of the spatial database containing datasets that represent geographic information in terms of a generic GIS data model (features, raster, topologies, networks, etc).
- ii) The Geo-visualization view: It is a set of intelligent maps and other views that show features and feature relationships on the earth's surface.
- iii) The Geo-processing view: It is a set of information transformation tools derive new geographic datasets from existing datasets. These geo-processing functions take information from existing datasets, apply functions, and write results into new derived datasets.

While on the subject, it is to be noted that the GIS-platform is dynamic and regular database updating is very important. It is not only the initial data generation, but also its subsequent updation, which is important for Disaster Management. Out dated data would not give us the desired mitigation and response effectiveness once a disaster strikes. There is a need to lay down SOPs and plans on regular and dynamic data base updation as well as protocol based data sharing.

4.5 Participatory Agencies and Nodes in NDMIS

The participating agencies of NDMIS network include:

- | | | |
|--|---|------------------------------------|
| <ul style="list-style-type: none"> i) NDMA, (NEOC), New Delhi ii) MHA (NEOC-Mirror), New Delhi iii) NCMC/PMO New Delhi | } | Decision Makers |
| <ul style="list-style-type: none"> i) NRSC, Hyderabad ii) INCOIS, Hyderabad iii) CWC, Delhi iv) IMD, Delhi v) GSI, Kolkata | } | Data Providers (Primary Nodes) |
| <ul style="list-style-type: none"> i) State Emergency Operations Centers (SEOCs) –
(at State capitals of multi-hazard prone states – Phase I) ii) Phase II User nodes expected to reach iii) Phase III User nodes expected to reach | } | 22nos.
User Nodes
182
433 |

Some of the above nodes like NRSA, INCOIS, IMD, CWC, GSI, etc. are identified as large volume data providers for decision making to NDMA (NEOC) and NCMC (PMO) and hence are designated as primary nodes with 2Mbps data transfer rate between themselves. The SEOCs are designated as user nodes with 512Kbps data links. The user nodes are initially SEOCs at the capitals of multi-hazard prone states. The user nodes will expand to 182 in Phase II and 433 in Phase III.

These nodes are categorized into two categories – primary nodes and user nodes. The primary nodes are either the data repository nodes (NRSA, MHA) or those with requirement of large data transfers like INCOIS, IMD etc. The user nodes are typically the State Emergency Operations Centers (SEOCs) at the Capitals of multi-hazard prone states (22nos in Phase I). The number of user nodes is slated to reach 182 in Phase II and 433 in the Phase III. The user nodes are basically consumers of application services hosted at the NDMIS repository.

4.6 Active Players of NDMIS

From the system point of view, the NDMIS system is a geographically distributed network of users accessing the centralized national-level GIS repository for data and services. Being a complex system consisting of centralized database with its own set of users at one end and the participating end-user agencies at the other.

Some of the major active players of the system are:

- Clients
- Data providers
- Data validators
- Information creator (service provider)
- Security manager

4.6.1 Clients

Clients represent the end users at the participating agencies like the SEOCs who make use of the data and services provided

by the central repository node viz. NRSA. The perspective at the client level can be summarized as:

- The clients should be able to view all the data sets and services provided by the central NDMIS database, suitable to their specific needs.
- The client requires a functionally rich, visually pleasing GUI based screens with ease of use features to maximize the utility of the services provided
- In the event of system failure at the primary database node (NRSA), the client system must be able to transparently fetch the data from the mirror node (MHA)
- The system response must be simple and easy to use at the client end without any compromise on the security aspect

4.6.2 Data Providers contribute relevant data sets generated by them to the central repository, for which they need to be provided with a mechanism to do so. The following points are relevant from the data providers' point of view:

- They should be able to provide their data sets to the central repository either by online transfer or by physical media transfer like CD, DVD or LTO tape media.
- Online data transfer would be via the NDEM network for data sets up to, say around 100MB-200MB.
- They need to be informed of the successful delivery of their data sets at the central repository.

4.6.3 Data Validators act upon the received data sets from data provider and verify that the data is received in the standard predefined formats. On satisfactory assessment of the above, the data validators make necessary format conversions to render the data amenable to store in the central repository in geo-database format. Their relevant points of view are as follows:-

- Data must be received in the applicable prescribed formats only. Software programs may be used to verify this.
- The data validators must be able to easily retrieve the data sets received from the data providers on to their own systems, preferably through automated and secure procedures.
- Suitable application software must be available to conduct the data verification and validation process and subsequent format conversions.
- Adequate disk space must be available to carry out the tasks, which may involve mosaics and other data intensive tasks.

4.6.4 Information Creator

A NDMIS node has to perform one or more of the following functional roles:

- GIS database repository hosting
- Management and administration
- Providing data (contributing data to database i.e. data provider role)
- Receiving data (from data providers – for ingest into database)
- Application services provider

- Application user

The 'GIS database repository hosting' role is limited to the NDMA and NRSC nodes. NRSC houses the centralized main database and an identical mirror image is maintained at NDMA, Delhi. The other participating agencies do not have this responsibility.

The complementary roles of data provider and data receiver play an important part in the NDMIS operations. The data providers like INCOIS, GSI, CWC, IMD, etc. contribute data sets that need to be incorporated in the central database at NRSC, which plays the role of data receiver. The NRSC node supports the necessary infrastructure to receive data sets from data providers online over the VSAT intranet via defined protocols. Apart from this, the data receiver role also covers the receiving of data sets via media transfer and from other local networks of NRSC. The data receiver node is also vested with the responsibility of performing all required data preparation and validation procedures prior to ingesting the data sets into the main NDMIS repository.

Since NDMIS is a highly secured network database of sensitive GIS base data, direct access to data sets by users is not recommended and all user access is mediated by a comprehensive set of application services running on the nodes hosting the database repository i.e., NRSC and NDMA. Hence, these two nodes support the role of application services provider. The application services include right from routine user interactions, database queries and map-based queries to Spatial Decision Support Systems (SDSS).

4.6.5 Security Managers

The role of security manager embodies many intricate sub-roles that are delegated or distributed among different persons for reasons of overall security. From the security point of view, the following points are necessarily incorporated in the architecture.

- The entire responsibility of security enforcement must not be vested with only one person.
- The system must allow the definition of different types of security realms based on the various possible functional responsibilities of administrators
- Network security could be delegated to one individual and SAN management for different database would be distributed among different engineers. The evolved system must support the implementation of this kind of flexibility.
- The system must support the creation of multiple roles of GIS administrators/ Data custodians who could be separate from the regular system or network administrators. The responsibilities for the content of various GIS database could be securely vested with different identified administrators of this type for enhanced data security.
- The system must support secure encrypted communication over the WAN network.
- The user authentication must be very robust and preferably support multi-factor authentication rather than simple username/password mechanism
- Audit logs must be supported to trace back any significant activity

- All the interconnected network segments must be securely isolated from each other.
- The network segment where the actual NDMIS database is located must be provided with enhanced security and isolation.
- Network wide protection from intrusion and virus threats must be provided.
- Data security and application security must be ensured so that their access by any authentic user must be checked against his/her access control privileges.

during rescue and relief operation and coordination & interaction activities with the community, NGOs and other agencies).

Because of the enormicity of the needed database for a large country like India, NDMIS will be developed in phases with continual up-gradation of the database, as and when upgraded inputs are available, starting with the basic inputs at the existing level of the cartographic scales and GIS data.

As the next generation infrastructure becomes more & more complex, based on advanced technology, we need to integrate new sources of information to estimate with better accuracy the potentials for various disasters without developing from the sustained focus for integration and connectivity to all the stakeholders. Further, the information infrastructure must be capable of supporting a variety of user knowledge, skills & experience.

4.7 Approach to Establishment of NDMIS

The entire NDMIS and Communication System are to be planned and implemented keeping in mind the essential needs for:

- (i) Stakeholders of disaster management (i.e., for the decision makers, local authorities and the threatened community). The need for the rescue and relief teams at disaster site should find special attention.
- (ii) Domain Functions for DM (for vertical domain communication involved in Command & Control purpose and horizontal domain communication for interaction, coordination and execution).
- (iii) Disaster Affected Site (for NDRF battalions and SDRF personnel, select groups of Armed Forces, the Police and Para Military Forces for their Command and Control functions

4.8 Special Features for Design of NDMIS

Effective design of systems and network architecture of NDMIS depends significantly on some of the special features involved.

4.8.1 Database and Its Volume

The NDMIS database is visualized as a comprehensive GIS database, which is necessary for making informed decisions and efficiently conducting all phases of emergency/ disaster management operations. Three different scales of 1:50K, 1:10K and 1:2K are envisaged. Also, the database is categorized into two categories: Core data sets and hazard-

specific data sets.

Assessment of the volume of data occupied by the NDMIS database is an important design criterion.

4.8.2 Data Preparation and Validation

In most cases, the data received from the various data sources is not in a form that is directly compatible with the NDMIS database internal formats. It is, also, not in accordance with best practices to directly update the NDMIS database with the received data. It has to be subjected to appropriate data preparation and data validation processes prior to committing it to the database.

In case of data received in the form of physical media, it must be first ingested into an intermediate system for data preparation and validation. Similarly, data received online on the file upload server must also be subjected to the same process. Often, it would be necessary to apply some image analysis and GIS processing tasks on the received data sets before they are suitable for incorporating in the NDMIS database.

It is envisaged to implement the NDMIS database as a geodatabase, which means that all the spatial and non-spatial GIS data including raster is stored in the form of RDBMS tables, and accessed via spatial data gateways. This implies that data, which is usually received in other forms, must invariably be processed for conversion to geodatabase format. The received data must also be sufficiently validated thereafter.

4.8.3 Documentation

It is essential to carry out the characterization

of the data and information products available to the user. Metadata, or “data about data,” is a key feature of data documentation and describes its content, quality, condition, and other characteristics. Metadata is one of the key features in the ability of the provider to meet the needs of the DM community. Metadata provides information to help the emergency manager determine what data is available, to evaluate its fitness, and ultimately to acquire, transfer, and process it. The order accessed and relative importance of metadata elements will vary by disaster type and phase. In addition, disaster managers with different objectives and working on different phases of a disaster may require the same information at different levels of abstraction.

4.8.4 Quality

Quality refers to the data/information accuracy and precision, as well as the adequacy of crucial metadata describing the data or information set (In a related arena, uncertainty refers to the confidence level associated with a warning or a product of prediction analysis). GPSs have significantly improved the quality and utility of data by providing enhanced geospatial reference for use in GISs, models, and other analysis tools. Finally, an important attribute of data quality is its heritage, which relates directly back to its documentation.

There is a growing reliance on data and information of questionable quality. The end user assumes that the information that has been passed to them is reliable, which may not always be true. Quality problems come into play in each step of product generation. The data may have been miscalibrated, the imagery merger

may have been offset, and the model algorithm may need to be modified for a given situation. Each misstep compounds the problem, and the disaster manager may be left with products that cannot be used. The most accurate capabilities need to be introduced in each operational step, and a means to trace this accuracy (e.g., metadata) needs to be incorporated into any system development. The “garbage in, garbage out” adage states the problem at hand.

4.8.5 Data Availability

The entire system must be designed for high availability. The mirroring of the main NDMA-NRSA database at MHA, Delhi is one element of high availability. The WAN link between NRSC and MHA nodes must also be configured with redundant links, one satellite based and the other terrestrial. There should be adequate redundancy features for each of the subsystem in the architecture. The high availability requirement encompasses both data and application services and extends right up to the client access level.

The high availability feature is also combined with load sharing features for performance enhancement wherever suitable. It is recommended to position redundant configurations with failover for all critical WAN and LAN network devices to avoid single point of failures. The routers of NRSA and MHA nodes are configured for automatic failover to the backup terrestrial link for non-disruption to the mirroring operations.

The application servers, authentication servers, RDBMS servers, map servers, etc. are configured as clusters for automatic failover and load sharing using softwares like cluster suite,

Real Application Cluster, etc. as applicable.

The SAN system including the switch fabric, RAID controllers, etc are provided with adequate high availability configurations.

4.8.5.1 Replication and Mirroring Management

Since the main NDMIS geospatial database, after initial implementation, is not expected to change significantly by the hour, the replication interval would be initially configured for 12 hours, and suitably modified later based on need basis. Further, the volume of updates is also not expected to be too high, the 4Mbps WAN link would also suffice for the task.

The mirroring process between the NDMA and MHA node is envisaged by design to be asynchronous in nature. The state-of-the-art features provided by the storage devices and RDBMS are taken advantage of to realize a reliable and customizable mirroring capability.

4.8.6 Client Access

It is envisaged that the end user must be able to access the NDEM services with minimum system administration or computer equipment complexities. A normal PC system with web browser is a very suitable and easy-to-implement in terms of end user equipment requirements. Hence, a browser-based interface is the preferred interaction for client access. If the user node has a LAN, it should be connected to the NDEM network via a suitably secure interface defined by the NDMIS architecture.

Accessibility: The availability of data and information to users is made within the constraints of policy and confidentiality. User data/information requirements invariably

address the issue of access. Knowledge of the existence of data/information, its availability and the tools necessary to acquire it are key attributes of access. The disaster manager and the provider must identify the technical and other barriers limiting access and make a cooperative effort to surmount them.

Standardization/Harmonization: This is similar to the previous finding but stands alone, reflecting the importance of uniform products to the DM community. The need to produce standard protocols is essential in a crisis situation. Even varying map symbology can greatly disrupt operational procedures. The development of a common information procedure, which can be broadly adapted within the DM community, is clearly desirable.

It is unrealistic to assume that standard procedures will be applied in the near future; there are simply too many unique products in existence. Land use classifications, for example, differ greatly among the various sources, and no single system development could hope to solve this complex problem. The idiosyncratic methodologies could be linked, however, in order for the disaster manager to make the wisest decision when faced with disparate data and information. A central taxonomy or hierarchy would need to be developed in order to achieve this goal.

4.8.7 Interoperability

Process that enables the inter-use of data/information products. Interoperability is a means to standardize (or harmonize) the data to ensure connectivity between the disaster manager and the provider community. Key features of interoperability include symbology, formats,

software, scale resolution, and frequency. In such cases where standards cannot be implemented, it is important to accommodate nonstandard data. This process, known as harmonization, is accomplished through software and other approaches.

4.8.8 Performance and scalability

Performance and scalability are two of the most significant technical criteria that influence the design of any system and network architecture. These two aspects have been addressed in sufficient detail while evolving the proposed architecture for NDMIS.

The NDMIS architecture incorporates multi-core/ multi-processor systems, high-end storage and network devices to ensure that both these criteria are met adequately to provide good system response even with the overhead of additional security levels initially and to support incremental upgrades to scale the performance or capacity as per future needs.

4.8.8.1 Performance

To obtain high performance from all the subsystems, the following has been adopted:

- Powerful server configurations including multi-processors
- Clustered servers
- High Speed SAN storage
- Gigabit switched LAN transport
- High-speed WAN/LAN network devices

It is recommended to realize the various server systems in the architecture, (like those used for authentication & identity management, RDBMS, map services, geo-processing, etc.),

two-processor or four – processor based systems with large memory sizes and configured for clustered operations are involved.

The SAN subsystem is based on high performance Fiber Channel (FC) technology with currently supported bandwidths of 4Gbps. THE RAID storage is also FC based with dual active-active controllers, large cache, parallel disk loops and multiple SAN fabric connectivity.

Network is one of the potential bottlenecks for obtaining high performance. In order to overcome this for the local network, the LAN is entirely based on switched Gigabit Ethernet with proper network segmentation. It is recommended to ensure high packet forwarding bandwidths and advanced features for the Gigabit switches. Link aggregation/trunking is to be utilized wherever possible to maximize network throughputs at servers. It is envisaged to use only high-end hardware appliance based firewalls, link load balancers associated with the WAN links at the routers ensure efficient load sharing as well as immediate automatic failover operations, which translates to good response times and high availability.

4.8.8.2 Scalability

Scalability features are to be built into any system to ensure that the system is adjusted for future-load and protected from short-term obsolescence while also optimizing the return on investment.

The server systems are all 2-way or 4-way so that processor scalability is assured, which is further enhanced by means of clustered configurations. By consolidating the disk system on to a high performance networked

mass storage system based on FC SAN, a very high level of disk capacity scalability is achieved. Though initially configured on 20TB disk capacity, the primary FC disk system is envisaged for scalability up to 100TB and more. The second-tier disk system is also configured on similar lines. The tape library is scalable from the initial 2-drive, 50 slots to 6-drive, 300 slots configuration, which translates to large near online capacity of over 200TB and higher overall removable media based offline capacity. Apart from the built-in scalability, modular augmentation of the disk and tape library systems with additional subsystems will further extend the capacities as well as the useful life of the infrastructure.

4.8.9 Application Services

The NDMIS database is a vast repository to valuable information-rich data resources. The details embedded in the data sets are quite comprehensive and the data sizes are generally voluminous. It is neither necessary nor practical for the end user nodes to access these data sets in their raw/native form due to a number of reasons like:

- They do not exactly match the target end use
- They could be too detailed or incomplete or devoid of required value addition in their raw form
- Data in its raw form would be too voluminous especially for WAN links
- Data security or laws could be compromised in providing direct access to highly sensitive data sets
- Data management would become

more complex

Therefore, all end user access and operations including that involving area specific data delivery must be mediated via a comprehensive set of application services. This applies to all interactions including simple queries, map-based interactivity and Spatial Decision Support Systems (SDSS)

4.8.10 Security and Protection of Data

Since the NDMIS database is a repository of highly sensitive spatial data including the high-resolution 1:2000 scale data sets, much higher level of data security is needed. Since data is the key component of the NDMIS database, it is mandatory to protect the valuable data resources in the repository from potential threats to data loss like hard disk failures, human errors and disasters. Appropriate backup and recovery procedures must be adequately implemented. Local as well as remote site disaster recovery mechanisms must be put in place.

4.8.10.1 Impact of Enhanced Security Levels on System Response

Ensuring security at all levels is one of the foremost considerations of the design of the NDMIS architecture. In achieving this design goal, other criteria like response time and flexibility are likely to be adversely affected. While this trade-off is to be expected in any security-enhanced architecture, the evolved NDMIS architecture takes necessary steps to ensure that response times do not unduly affect the initial stage as well as the later stage.

One direct way to provide good response times is to implement sufficiently powerful servers and network devices so that the overhead

due to additional security is effectively overcome. The multi-core multi-processor configurations of servers and high-end hardware firewalls are in line with achieving this objective. Similarly, the scalability features of the subsystems also ensure that the desired system performance can be obtained or improved upon, whenever the need is felt for the same.

Towards this end, appropriate security mechanisms are required to be put in the place at multiple levels –physical, WAN, LAN, host and data. Encryption of network transmissions must be implemented wherever called for. Similarly, encryption of file data on removable media is also warranted. Network wise antivirus measures must also form part of the security suite. Above all, robust authentication, authorization and role-based control for data sets and applications need to be enforced.

As part of physical security planning, it is also required to identify the group of subsystems that need to be placed together or separated, and the level of access that needs to be provided for each of the physically segregated areas. This should enable the implementation of varying physical access constraints.

Details of five levels of security of the proposed NDMA/ NRSC nodes are shown in **Appendix-II**

4.8.11 Data Protection

To recover from disaster related loss of data, adequate disaster recovery solution is provided in the architecture by way of DR unit NDMISC database at a geographically separated infrastructure at NRSC, Hyderabad.

The mirroring process is done over the satellite WAN link or over the terrestrial backup link.

4.8.12 Action Points

- (i) Obtaining Digital Cartographic Base at the appropriate scales and contour intervals;
- (ii) Obtaining the upgraded hazard maps of India with respect to various natural hazards (in term of locations, frequency, duration and intensity);
- (iii) Establishing the necessary computational and data handling hardware along with necessary software, for development of various applications on the GIS-platform for the hazard profile to empower the stakeholders (during pre - during and post - disaster scenarios);
- (iv) Development of Vulnerability Analysis & Risk Access Tools (VA&RA);
- (v) Development for Decision Support System(DSS).

5

Establishment of National Disaster Communication Network

5.1 Introduction

The aim for establishing National Disaster Communication Network (NDCN) is to create a digitized, converged, adequate, reliable, responsive, inter-operable, self-healing, redundant and diverse technology based Communication and IT Network with the desired NDMIS capability in support of the complete disaster continuum. Essentially, being a network of networks, NDCN will be operationalised based on existing and planned National Terrestrial and Satellite Infrastructure, whether public or private. In accordance with organizational and functional structures of various DM stakeholders, Communications and IT support activities of NDCN could be viewed as a system involving number of existing interdependent but geographically separate sub-systems or basic networks connected together to provide ICT support to Disaster Management. In terms of additionalities, however, NDCN would be extended to all NDRF battalion stations in addition to Mini Mobile Communication Pack and transportable Mobile Emergency Operations Center (MEOC) with added bandwidth to be airflown by NDRF. This network of networks will be backed up by VSAT

network (to be created in the proposed NDCN) to provide its fail-safe character under all phases of disaster scenarios.

5.2 NDCN in a Nutshell

NDCN will provide assured multi services such as audio, video, data and knowledge based information to meet the requirement of various stakeholders for proactive and holistic management of disasters, with particular emphasis on last-mile connectivity to affected community during all phases of disaster continuum.

NDCN will be a network of networks created by leveraging existing communication networks, including NICNET, SWANs, POLNET, DMNET (ISRO) and connecting them to various Emergency Operation Centers (EOCs) which will be established at National (NEOC), State (SEOCs) and Districts (DEOCs) Level. The Disaster Recovery (DR) site for NEOC has been envisaged to be located outside Delhi, away from NEOC in another geographical location.

The NEOC will be connected to the DR site by redundant communication link with high bandwidth. Operational control room (OPS) will be established in NDMA Bhavan and NEOC

will be linked to NDMA OPS room through reliable redundant communication media. The OPS room setup of NDMA will be replicated in Ministry of Home Affairs (MHA) and it will be connected to NEOC through redundant communication link.

In addition to the Emergency Operation Centers at National, State and Districts Levels, last-mile connectivity will also be ensured through a mobile/transportable communication system to establish graded communication capability at the disaster sites. Each district will be provided with a specially designed Mini Mobile Communication Pack (MMCP) with satellite phones and VHF radios, which can be transported (in a vehicle to be arranged by the district authority) to the disaster site immediately.

To augment the bandwidth at the affected site, each NDRF battalion will be provided with VHF, VSAT, and IT equipment like Laptop, Cameras and Diesel generator sets in a custom-built vehicle, pre-wired for installing communications system to function as Mobile Emergency Operations Center (MEOC) at the disaster site.

Subsequently, the communication equipments in MEOC will be supplemented with micro-cellular/ WiMax systems as and when these technologies mature to offer equipments that are quickly deployable and easy to handle to meet the requirements of disaster scenario.

At each of the base stations of NDRF, provision would be made for VSAT and cellular mobile handsets in CUG mode in addition to normal communication facilities.

All the stations of NDRF will be connected to the NDCN by creation of appropriate terrestrial as well as satellite connectivity. In addition, transportable MEOCs, cited earlier, will be maintained operational for ready deployment at NDRF battalion stations.

State-of-the-art knowledge-based National Disaster Management Information System (NDMIS) will be set up at NEOC of NDMA to provide GIS-based value-added right information to the right people at right time. These value added information along with conventional voice, video and data would be disseminated through NDCN.

During peace time, connectivity to the last-mile for various DM activities (like awareness generation, preparedness, capacity development etc) at the various levels of administrations will be based on existing terrestrial networks of various operators in the country as well as various VSAT Networks such as POLNET, NICNET, DMS of various agencies.

However, during disaster scenarios, terrestrial communication networks are quite likely to be affected, disrupting the communication connectivity (which is most crucial for response and relief work). To overcome this difficulty, NDMA will establish separate satellite network of NDCN (through VSAT Network connected to NDMA Hub located at appropriate place), as a backup for disaster failsafe character of NDCN.

Reliability will be ensured through adequate bandwidth availability using dedicated leased lines, by entering into appropriate Service

Level Agreements (SLAs) with various operators. Operator and communication media diversity will be ensured by connecting to more than one service providers as well as satellite connectivity for supplementing terrestrial connectivity.

Implementation and subsequent operation and maintenance of NDCN will be entrusted to the implementation agency (appointed by NDMA) for the initial 5 years.

Recruitment and training of regular operational and administrative staff for the proper utilization of NDCN will be done by respective SDMA's with assistance from NDMA, if required.

In this context, it may be observed that survivability of communication system under a nuclear attack scenario generating Electro Magnetic Pulse (EMP) effect over a large area, calls for an entirely different approach in its design and implementation. These special features of communication network required to survive EMP scenario is outside the purview of this document.

5.3 Approach for Establishment of NDCN

The basic concept revolves around creation of a dedicated, multi-layered, multi-systemic, inter-operable and converged (Voice, Data & Video) Sub-Continental Networks with a distributed architecture, utilizing the existing National, State and District level Communication Infrastructure to the maximum possible extent. The Network will be hosted on the terrestrial backbone (optical fiber/microwave) with Satellite media as its backup and the last mile

connectivity would be based on satellite and VHF links with evolution towards micro-cellular / WiMax / Wi-Fi systems. During live disasters or any unforeseen contingency resulting in non-availability of integral network, available Governmental as also Public/ Private Networks including Ham Radio, where available, would provide the incidental back-up support. This facet would require appropriate positioning and deployment of multi-service platforms both static and mobile.

The complete Network Architecture should have EOCs with Static and Mobile Communication Access Platforms (SCAPs / MCAPs) for multiservice at all levels for extending the last-mile connectivity to the affected community as shown in Annexure 10. Requisite hierarchical network management with desired manual/automatic gateways would ensure the right connectivity for execution control, coordination and interaction as also EW /information dissemination. It should also cater for Voice /Video Conferencing and Voice/Video Hotlines on demand. The planned Architecture should be dynamically reconfigurable for the complete DM continuum from routine functioning to active/ live DM. MEOCs will be equipped with requisite scales of Communication and IT equipment and co-located with NDRF battalions for deployment during live disasters.

The Network should also cater for NDMIS with due emphasis on Data Fusion, Data storage, Data mining and simulation etc. Desired protocols, forms and formats will be designed and worked out for information sharing between various agencies and constituents of NDMA.

The existing NEOC-I at MHA and the proposed NEOC-2 of NDMA would be mirror-image to each other by appropriate up gradation of the existing NEOC-1. The Disaster Recovery (DR) Center is proposed to be in NRSC Hyderabad. Network engineering should include in its scope Data Warehousing & Data Mining of information collected from Satellite pictures, climatic conditions, Meteorological data & other precursors of impending disasters.

SEOCs at States/UTs and DEOCs at 312 multi-hazard prone Districts should be established with guidelines and fund support from NDMA.

Interactive Websites should be established at National and at State levels for DM. The Websites established at State level will be Multi-lingual (Hindi/ English/State Specific language).

Main thrust is to integrate disparate Networks through Gateways to ensure interoperability and seamless connectivity.

The following are the major assumptions and based on these assumptions, the multi service Network Architecture approach is suggested for National, State and District level EOCs.

- The user interface provided by all Service Providers has IP as the core protocol.
- The communication centres for all service providers are located in the same city/district where the EOCs are going to be established for Disaster Management.

5.4 Special Features of NDCN

- (i) The biggest challenge to establishment of NDCN lies in its responsiveness, availability and survivability for providing real/near real time Communication and IT Support during live disasters with particular reference to EW receipt and its dissemination to the affected community in disaster hit areas.
- (ii) Creation of planned Communication and IT assets would require appropriate work station based Static and Mobile EOCs for effective DM. At each of the functional levels, the plan is to establish EOCs which would cater for requisite work space along with Communication and IT connectivities and administrative support facilities for control, coordination and management of disaster.
- (iii) While at National, State and District levels, it would be in the form of Static EOCs, for control of live disaster site by NDRF battalions, these would be mobile and vehicle based. Integrated Basic Network (voice, video & data) is given at **Annexure 11**. Information access is given at **Annexure 12**.
- (iv) As the overall network, it is planned to create an Intranet for DM with required gateways. It is therefore, proposed to develop the Network in an evolutionary and phased manner so as to stay in tune with the "National DM Plan", the associated Infrastructure and fund availability.
- (v) Main thrust is to integrate disparate Networks through Gateways to

ensure inter-operability and seamless connectivity to achieve the targeted objectives. The fundamental objective is to ensure that at the time of disaster, the Network should be able to connect up with any available Communication and IT connectivity. Additionally for data exchange, the bandwidth requirement will be minimal during routine functioning, but will have to be dynamically upgraded during management of live disasters: particularly for NEOC, affected SEOC & DEOC, deployed NDRF Units and concerned EW Agencies.

- (vi) Call Centre based 'Help Lines' should be established at various levels for routine functioning and will be duly beefed up during management of live disasters. These call Centres, of necessity, would have to be Multi-lingual (Hindi / English / State Specific language).
- (vii) Concept of a personal Emergency Call number for Disaster Management Nodal Officers, which will be on an all India basis.
- (viii) A GIS-based Data Fusion Centre, called National Disaster Management Information System (NDMIS) would be established at NEOC-II of NDMA, which will be connected with State Data Centres, SEOCs and DEOCs with adequate data storage capacity. In addition to upgradation of the NEOC-1 at MHA with respect to its connectivity and capability, a mirror image for the Data Fusion Centre will be set up, in NRSC, Hyderabad to serve

as the Disaster Recovery (DR) site for NDMIS.

- (ix) Hybrid approach i.e Top-Down for Fused data and Bottom-Up for Basic Data must be followed. The Network should, therefore, also cater for NDMIS with due emphasis on Data Fusion, Data storage, Data mining and simulation etc. Desired protocols, forms and formats will be designed and worked out for information sharing between various agencies and constituents of NDMA.

5.5 Operational Characteristics of NDCN

DM Communications and IT support involves large and complex networks spread over the entire Sub-Continent while catering for a host of applications: both static and mobile. There are, therefore, certain key characteristics, which are to be kept in mind while planning such Information & Communication Technology (ICT) Networks. These, in outline, are given in the succeeding paragraphs.

- (i) Requisite prevention, preparedness, mitigation efforts and EW are fundamental to the pro-active approach to DM, both in the context of inputs from EW Agencies as also conveying the same time-sensitive warnings to the affected community simultaneously, and in multi-mode, multi-lingual & in real/near real time basis. Software support and automation are the key ingredients in such an environment with continuous data input and updating being a key factor.

- (ii) It must cater for real/ near real time situational awareness for the management, the response forces and also, for the general public and media.
- (iii) The Network should support all complexities and shades of Geographical Information System (GIS) and location based services whether Global Positioning System (GPS) or Mobile Positioning System (MPS) based.
- (iv) Networks should be able to provide shared common picture of the disaster site to various management and response constituents and, also for media briefings and bulletins.
- (v) The ICT support must be dedicated and cater for 24 X 7 availability with desired levels of prioritization and built-in reserves at appropriate levels.
- (vi) The Network architecture and equipment must be open ended for desired inter operability amongst all Service Providers, Response Forces and for any other incidental backup by Governmental/ Non- Governmental/ Private Organizations.
- (vii) The complete 'Network' should be secure and self healing where required.
- (viii) For live DM, disaster site Communications and IT Networks should be dynamically upgradeable and configurable with respect to:-
 - (a) Time sensitivity: real / near real time.
 - (b) Graded response for build-up from minimum resuscitation to full scale back up including for affected community and media support.
 - (c) Capability to create telephone booths (local /STD/ ISD) and Information Kiosks for public use in a phased manner.
 - (d) Must cater for converged and hybrid information flow: i.e vertical for command and control and horizontal for coordination and execution
- (ix) Network must have adequate mobility and transportability with last mile connectivity in wireless mode; preferably micro-cellular whether Tetra or GSM / CDMA based. Mobility could be road, rail, air and waterways based.
- (x) The ICT Network should be managed through hierarchical 'Network Management and Control' with desired capability to create Close User Groups (CUGs), VPNs, and hotlines for voice and video on demand. Video conferencing facility should be in-built: both for active DM as also for training and awareness.
- (xi) The Planned Architecture must be in tune with emerging IT and Communication Technologies.

5.6 Technology Issues

On the basis of the overall architecture of NDCN, the design principles and the traffic analysis, broad design basics of NDCN are to

be finalised. The broad outline is furnished below:

5.6.1 Design Principles

Key parameters considered as part of NDCN architecture are Standards based design, High Availability (Redundancy), Scalability, Optimization, Security and Integration.

5.6.2 Performance

In addition to the provision of adequate redundancy of the equipments and links, the equipments in NDCN shall have high backplane switching and routing provisioning to meet the performance requirements. The equipment shall support protocols and mechanisms like policy based routing, traffic classification, prioritization and queuing mechanisms to fine tune performance requirements for NDCN. The proposed routers should have scalable memory to accommodate any future performance requirements.

5.6.3 Network Management Segment

This segment utilises Network Management System (NMS) located at NEOC to carryout Network and Fault Management, Network performance management and Helpdesk system to act as a SPOC (Single Point of Contact) for all the Network & Security related issues reported by the government departments or any other related stakeholders of the NDCN. Network and Fault Management function continuously monitors the status of the network, reports the various faults and provides measures to rectify the faults. The measurements of various parameters that would define performance of CPU/memory utilization, links, interfaces and network would be measured

using performance management tools which would be part of Network Management System (NMS). Continuous monitoring for compliance to assured bandwidth from the operators would be carried out thru NMS located at NEOC.

5.6.4 Typical bandwidth requirements for the Network

For satellite segment, generally the bandwidth requirement will be based on the peak traffic to be carried during simultaneously active satellite terminals for providing voice, video and data. For example, one transponder with 32 Mbps capacity may be required for the VSAT connectivity based on the following traffic load assumptions:

- A maximum of 100 VSATs will be active.
- 10% of the 100 active VSATs will have video conferencing and voice requirements.
- For voice and video traffic, 512 Kbps is required and for data traffic 64 Kbps is required.
- For 10 VSATs, voice and video will require around 5 Mbps and data from 100 active VSATs will require around 6 Mbps
- So, the total bandwidth required is 5 Mbps + 6 Mbps =11 Mbps
- Considering some buffer, 16 Mbps will be required for one way communication. Therefore, two way communication requires a total of 32 Mbps.

In the terrestrial segment, all prioritized stakeholders will have dedicated 2 Mbps connectivity to NEOC, which can easily address

the DM bandwidth requirements. During a disaster, the government agencies in the affected area will be involved in disaster management activities. Therefore, entire bandwidth of Government Organizations will be available for NDCN.

5.7 Overall Architecture of NDCN

The NDCN network comprises of vertical and horizontal connectivity. The vertical connectivity consists of Emergency Operations Centres across national, state, district and incident area levels. The horizontal connectivity consists of connectivity with various stakeholders, who need connectivity to NDCN for effective Disaster Management (DM). Requisite number of gateways coupled with hierarchal NMS would provide the desired cross connectivity, redundancy and reliability by interconnecting various Networks from other users and departments (both public and private). The overview of NDCN is given below.

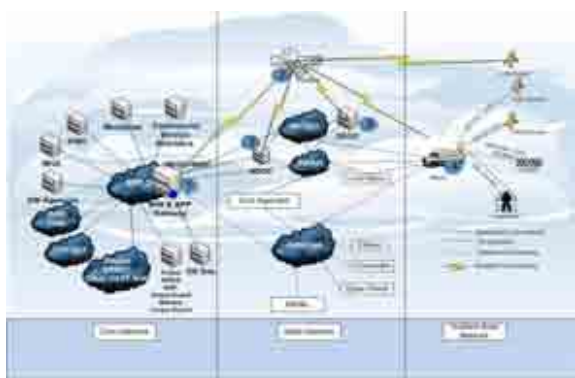

5.7.1 Connectivity from National to State HQs would be established on dedicated Terrestrial Connectivity from Centre to States/UTs by hiring optical fiber based 2 Mbps Channels from Telecom Service providers, for Voice/Data/Video.

This could be upgraded to 8 Mbps, depending upon the requirements, backed by satellite links of ISRO with bandwidth of 2 Mbps. All the Network/Terminal equipments should be capable to take load of at least 8 Mbps. Both the links viz. OFC and Satellite will work simultaneously. There will be interconnectivity amongst ISRO, ANUNET, National Remote Sensing Centre, Dept of Space, Dept of Science & Technology, MHA, NDRF Battalions, Crisis Management Group, Disaster Management Group etc.

5.7.2 Connectivity from State HQ to District HQs would be established on the existing network comprising of optical fiber / microwave links of Telecom Service providers like BSNL etc. as well as on state resources of SWAN with bandwidth provision of 2 MBPS (upgradable to 8 Mbps) backed by Satellite links of ISRO with bandwidth of 2 MBPS. All the Network/Terminal equipments should be capable to take load of at least 8 MBPS. Both the links, viz. optical fiber and satellite, will work simultaneously (to be done by State with Central funding for achieving the requirements of NDMA). Communication Gateway should have capability to take up Communication of Telecom Service providers networks like BSNL, mobile service providers, Police and integrate any surviving Communication media at the time of disaster-terrestrial, mobile, wireless.

5.7.3 Connectivity from District HQs to Sub-divisions/Blocks

The NDCN will ride on existing resources of SWAN with bandwidth provision of 2 MBPS for connectivity from District HQs to Sub-division/Blocks (to be done by State with Central funding for achieving the requirements of NDMA).

5.7.4 Last Mile Connectivity & Communication Build-up at Disaster Site

Expeditious restoration of Communication at the disaster site from minimum essential to full scale, in graded manner using a composite transportable “Communication Pack” consisting of:

- (a) Mini Mobile Communication Packs (MMCPs) to be provided to each of 312 Multi Disaster Prone Districts, comprising of minimum essential Communication equipments for their immediate movement to disaster site on occurrence of a disaster for emergency resuscitation of communication. This MMCP would also be added with a Laptop to provide data communication from disaster site.
- (b) The bandwidth will be enhanced through arrival of NDRF Battalions with Mobile Emergency Operation Centres (MEOCs) for providing voice, video and data communication. The requisite Communication infrastructure will comprise of VSAT terminals, satellite phones (INMARSAT/INSAT), VHF radio Sets, etc as shown in the Annexures 16 & 17

5.7.5 Last Mile Connectivity (LMC) for the Disaster Site.

Communication technology with the following features are proposed for last mile connectivity.

- i) Network to be functional and operational, effectively and efficiently even in worst disaster situation.
- ii) Convergence of networks – voice, data, video transmission through one

portable equipment on static, mobile and hand-held mode.

- iii) Easy transportability of Communication equipment to the place of occurrence.
- iv) Integration of various communication networks
 - HF/VHF network of Police Communication
 - VSAT based network viz. POLNET, NICNET etc
 - VSAT based Network of ISRO for Early Disaster Warning etc
 - SWAN
 - Communication Network of various law enforcing agencies viz, Army, Paramilitary forces, State Police Organisation.
 - HAM
 - GSM service provider
- v) Accessibility by public on real-time basis
- vi) Security and reliability of the network even in worst disaster situation

5.7.6 Last Mile Connectivity (LMC) beyond Blocks/Talukas to Villages should be extended

under States/UTs arrangements, based on WiMax/ Wi-Fi/ Wireless Mesh Radio/ VHF Radio, Micro Cellular technology as considered appropriate by the concerned States/UTs.

Broadly, LMC should consist of :

- Satellite based early warning system with GPS facility having remotely activated alarm.
- Satellite based disaster warning system with both way communication (voice &

data) from the disaster site having GPS facility.

- Multi service communication platform to Responders for connectivity to various aid agencies viz. Health, Police, Fire, NGOs, Paramilitary forces etc.
- Pre-disaster Communication for fishermen at sea area to provide Satellite based disaster warning system with GPS facility.

5.8 Forecasting and Early Warning

Forecasting and Early Warning is the non-structural mechanism essential for minimizing losses of life and property and enabling the agencies concerned to plan rescue and relief measures.

An advanced system of forecasting, monitoring and issuing early warnings plays the most significant role in determining whether a natural hazard will assume disastrous proportions or not. It is essential, therefore, that an early warning system becomes an integral part of National and local Government policy and procedure subject to regular review, testing and drills so as to respond to institutional changes and take into account local demography, gender, cultural and livelihood characteristics of the target population.

5.8.1 Advance Forecasting of Hydro-meteorological Hazards for DM

The advances in atmospheric modeling, weather parameter observation means for quality data and availability of super computers have enabled the S&T communication to improve

forecasting of hydro-meteorological hazard like cyclone, flood, and drought, both in terms of lead-time as well as land-fall.

Considering the complexity of the task involved in forecasting of Hydro-meteorological disasters, the nodal agencies in India (viz IMD along with NCMRWF for cyclone and CWC for flood) are providing seasonal weather forecasting and early warning on regular basis to all the stakeholders (based on Global Circulation Models available from abroad with necessary validation from the observation stations distributed in the field). They have also undertaken their respective modernization plans for upgrading the forecasting and early warning capabilities through improved modeling and validation of the same utilizing the observed data (collected from advanced automatic monitoring instruments to be located in the field at higher density and wider coverage of the disasters prone areas).

However, from the consideration of proactive disaster management, there is still the need to improve the forecasting capability in terms of lead time, reduced error in prediction of cyclone track and land fall, prediction of intensity and duration of cyclone etc. The present day models available in India have limitations in prediction of (i) extreme weather events like heavy rain falls (greater than 250 mm in 24 hours), mesoscale events (about 25 x 25 km) like cloud bursts, orographically enhanced rain falls etc. and (ii) heavy rainfall taking place along the foot hills of Himalayas that lead to flood situations in many states in the downstream. Since the above forecasting capabilities are essential for effective management of disasters

in a pro-active fashion, NDMA has taken the necessary initiative to induct the services of various domain experts in the S&T community to develop an Advance Forecasting Platform, with an overall objective of strengthening the operational forecasting capabilities of IMD/ CWS.

5.9 Action Points

- (i) Planning should include operator and communication media diversity by connecting to more than one service provider as well as satellite connectivity for supplementing terrestrial connectivity
- (ii) Utilisation of existing and planned National Terrestrial and Satellite Infrastructure, whether public or private.
- (iii) Planning of overlay VSAT network to provide fail-safe character under all phases of disaster scenarios.
- (iv) Ensuring reliability of the network with adequate bandwidth availability by entering into appropriate Service Level Agreements (SLAs) with various operators/service providers providing leased lines.
- (v) Establishment of interactive websites at National and at State levels for DM. The Websites established at State level shall be Multi- lingual (Hindi/ English/ State Specific language).
- (vi) Establishing Multi- lingual (Hindi / English / State Specific language) Call Centre based 'Help Lines' at various levels for routine functioning and shall be duly beefed up during management of live disasters.

6

Emergency Operations Centres: Connectivity, Database & Applications Development

6.1 Introduction

For an effective, prompt and efficient management of the disasters, the knowledge based information will augment the traditional multi-services (audio, video & data) and it will be assured to the stakeholders at different levels of administration including the community through NDCN (that would provide the necessary link to the stakeholders by a set of distributed subsystems, called Emergency Operation Centers (EOCs)), to be established at national, state and district levels. Assured connectivity would be extended to the disaster affected site through another set of mobile (at district level) and transportable (at NDRF battalion level) EOCs. The existing NEOC at MHA, SEOCs/DEOCs in five states [that were originally contemplated in 2004 under the NECP and subsequently have already been established through State Wide Area Network (SWAN) under the **National E-Governance Action Plan** (NeGAP)] will be upgraded in terms of connectivity and capability (for last mile connectivity)

Initially, this set of distributed subsystem, (i.e. EOCs) will be loosely coupled (in the sense, these would be more or less independent in nature with their own independent computer

hardwares, softwares and data base to meet the specific requirement at their respective level of administration). Ultimately, however the NDMA will strive to establish complete integration amongst the various subsystems - EOCs at national, state, district and mobile EOCs at disaster site spread over the nation. This network would ride over both Static (i.e. fixed) as well as Mobile Communication Access Platform (SCAPs & MCAPs) with the necessary vertical as well as horizontal linkages required to ensure the last mile connectivity on 24x7 basis for a fast, efficient and appropriate information services required for holistic management of disasters during all the phases of disaster management continuum.

The NEOC at NDMA would be a Data Fusion center that receives the data (both spatial and non-spatial in GIS platform in the form of various layers) and collates these information layers into various types of knowledge-based information, decision or decision support system (DSS) and disseminate the same in the vertical as well as horizontal domain for execution and control, through the EOCs connected by the National Disaster Management Network spread all over the country.

EOC is a central command and control facility responsible for carrying out the principles of disaster preparedness and disaster management functions at a strategic level in an emergency. The common functions of all EOC's is to collect, gather and analyze data; make decisions that protect life and property, maintain continuity of the organization, within the scope of applicable laws; and disseminate those decisions to all concerned agencies and individuals.

The Emergency Operation Centres (EOCs) function at full scale round the clock after the receipt of the first information about the occurrence of major natural disaster, for a period specified by the concerned nodal ministry for dealing effectively with the crisis arising out of a natural disaster.

Each EOC is designed and developed in such a manner as to normally work in an independent way to fulfill the local requirements. In addition, it will also be given the capability to access or send information from/to any of the EOCs in the National Disaster Management Network.

The role of the sub-systems can be one or combination of the following activities required for disaster management that are to be executed in a transparent way.

- Data/Information Providers
- Data/Service Users and
- Service Facilitators

It is proposed to setup two EOCs at National level, one (NEOC-2) at NDMA and the other in MHA (NEOC-I)(where the existing EOC needs adequate strengthening). The national

EOCs are basically Data Fusion Centres that were referred to earlier. It is planned to setup 22 State EOCs and 312 District EOCs (that are in MHP areas) in the next 3-4 years. In addition, Mobile Emergency Operation Centres (MEOCs) are also planned at ten NDRF stations and Mini Mobile Communication Pack at all MHP district headquarters for expeditious restoration of communication at the neighbouring disaster sites.

6.2 Flow of Information for EOCs at Different Levels

The data flow and information requirements for Disaster management in EOCs can be broadly categorized under two heads viz: a) Command and Control Purpose and b) for Interaction, Coordination and Execution purpose. The data flow for Command Control is in vertical domain and the data flow for interaction, coordination and execution is in horizontal domain.

6.2.1 For Command and Control

For the command and control, the information flow is as given below

- i) NDMA \leftrightarrow SDMA and NDRF (Two way Communication)
- ii) SDMA \leftrightarrow DDMA and NDRF (Two way communication)
- iii) DDMA \leftrightarrow NDRF (Two way communication)

6.2.2 For Interaction, Coordination & Execution

In the horizontal domain, the NDMA is linked with Early Warning /Forecasting agencies (NRSC, NTRO, CWC, IMD, GSI, SAC, NCP/INCP and CBOs/others), important central Government

agencies (PMO, NCMC, MoD, NEC, MEA, NIDM, NIC and BSNL) and various Emergency Support Functionaries for interaction, coordination and execution.

Similarly, corresponding & similar linkages, as applicable at SDMA/DDMA level are to be identified and designed in the horizontal domain for interaction, coordination and execution

6.3 Vertical and Horizontal Connectivity of NDCN

- (i) Vertical connectivity
- (ii) Horizontal connectivity

The vertical connectivity consists of Emergency Operations Centre (EOC's) across national, state, district and incident area levels. The horizontal connectivity consists of connectivity with various stakeholders, who need connectivity to NDCN for effective Disaster Management (DM).

(i) Vertical Connectivity

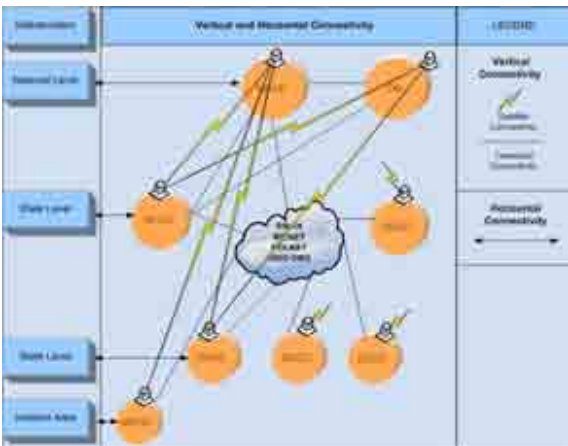

The vertical connectivity of the NDCN consists of the following four components:

- National Emergency Operations Center (NEOC)

- State Emergency Operations Center (SEOC)
- District Emergency Operations Center (DEOC)
- Mobile Emergency Operations Center (MEOC)

The EOC's are connected through a primary terrestrial and secondary satellite network for redundancy establishing connectivity between NEOC with

- SEOC's
- State Wide Area Network (SWAN)
- National Informatics Center Network (NICNET)
- Police Network (POLNET)
- ISRO's Disaster Management System (DMS)
- Various Stakeholders

The NEOC is a hub for the satellite network and all VSAT's at different levels connect to this hub.

For redundancy at NEOC level, a Disaster Recovery (DR) site is proposed. The DR site is an exact replica of the NEOC and is planned at a location that is in a different seismic zone than the zone in which NEOC is located. The DR site has terrestrial connectivity to SEOCs, SWAN, NICNET, POLNET and ISRO DMS. The DR site is a secondary hub for satellite network and in the event of a disaster at the NEOC, satellite connectivity is established from the DR site.

(ii) Horizontal Connectivity

The horizontal connectivity connects to various stakeholders who play an important role

during a disaster. NDCN facilitates connectivity among various stakeholders for effective DM. The stakeholders are identified at national, state, district and incident area network and connectivity to them is established through the existing infrastructure such as SWAN, NICNET, POLNET, ISRO DMS etc. Quite a large number of such stakeholders have their own ICT network that would be interfaced with the existing main infrastructure. In cases where connectivity through existing infrastructure does not exist, the NDCN provides provisions for connectivity to these stakeholders.

6.4 Detailed Design of the Core Network

The design of the core network includes understanding requirements, designing of architecture and identifying the components at NEOC, SEOC, DEOC and MEOC. In the following section each of the aforementioned activities at different levels have been presented in detail.

Design of Core Network - NEOC



6.5 Functional Role of NEOC of NDMA

- (i) Maintain cartographic base with GIS platform for all the districts (with priority to multi-hazard prone districts)

at appropriate scales alongwith Hazard Profile Information of the Districts and carryout VA & RA at appropriate scales for various applications in DM continuum and Decision Support Systems in advance.

- (ii) Develop DMIS for prevention, mitigation, preparedness and capacity development programme at various levels of administration in a proactive approach.
- (iii) Receive Early Warnings to disasters (in a pro-active approach to DM), from EW Agencies and convey the same time-sensitive warnings to the affected community in multi-mode, multi-lingual & in real/near real time basis.
- (iv) Cater for real/near real time situation awareness for management, the response forces and also, for general public and media. System should provide shared common picture of the disaster site to various management and response constituents and also, for media briefings and bulletins.
- (v) Receive data in the horizontal domain & providing the knowledge to the field personnel in command and control mode
- (vi) Maintain of Web Sites with National and Regional languages, State and District Disaster Management Portal Development with value added services.
- (vii) Execute data mining and Simulation Systems for the pre-disaster scenarios
- (viii) Call Centre based help lines during disaster

- (ix) Keep close contact with the State Governments affected by natural disaster and gather information about the disaster affected areas and provide advisories.
- (ii) Central Govt. Agencies (MHA, NDMA, PMO, DOS, DCPW, NIC etc)
- (iii) Emergency Support Functionaries (ESF)

(where Response and Rehabilitation are the major activities)

- (x) Interact with other Central Ministries/ Departments and coordinate the relief and rescue activities and continuous monitoring of the impact of the disaster.
 - Ministry of Agriculture
 - Ministry of Chemicals and Fertilizers
 - Ministry of Civil Aviation
 - Ministry of Communications and Information Technology
 - Ministry of Consumer Affairs, Food and Public Distribution
 - Ministry of Defence
 - Ministry of External Affairs
 - Ministry of Finance
 - Ministry of Health and Family Welfare
 - Ministry of Heavy Industries and Public Enterprises
 - Ministry of Home Affairs
 - Ministry of Housing and Urban Poverty Alleviation
 - Ministry of Information and Broadcasting
 - Ministry of Ocean Development
 - Ministry of Power
 - Ministry of Railways
 - Ministry of Science and Technology
 - Ministry of Shipping, Road Transport and Highways
 - Ministry of Urban Development
 - Ministry of Water Resources
- (xi) Prepare the daily situation report and apprising the Cabinet Secretary, NDMA and the other important functionaries.
- (xii) Publishing the daily situation report on the website.
- (xiii) Provide information to National Crisis Management Committee (NCMC) for the following activities:
 - Review every year contingency plans formulated by the Central Ministries/ Departments
 - Review the measures required for dealing with natural disasters.
 - Coordinate the activities of the Central Ministries and State Governments in relation to disaster preparedness and relief, and obtain information from the Nodal Officers of the Ministries/ Departments on measures relating to the above.

6.6 Stakeholders of NEOC, NDMA

- (i) Forecasting & EW Agencies (IMD, CWC, GSI, NRSA, NIDM, NTRO, INCOIS, Survey of India, NSDI, SAC, etc.)

- Department of Atomic Energy and
- Department of Space
- iv) SEOCs, DEOCs, NDRF
- v) NGOs

6.7 Applications and Database Required at NEOC

6.7.1 Application Requirement

The applications required in Emergency Control Rooms can be grouped into six major categories as given below.

(i) For catering to the needs in the Pre-Disaster Scenario:

- **Vulnerability Analysis and Risk Assessment System:** With detailed information on vulnerability analysis, it would be possible to construct models that predict the impact of a given event in a specific time/place. Scenarios can be developed at various levels of sophistication that forecasts casualty patterns, scales of damage and the secondary economic impact of the disaster in relation to varying scales of hazard impact. Such predictions have a wide variety of applications in disaster management. Various GIS and Remote Sensing application products shall be integrated as a part of tool library in this module. Various utilities/tools shall be developed and included in this product library.

- **Alert Messaging System:** Alert Messaging System can be used to send E-mail, SMS & FAX within a Close User Group (CUG) of disaster managers. This system facilitates archiving the messages for future retrieval & reference. The Alert messages may be text, audio or video. The Alert messages may be in synchronous or asynchronous mode.
- **System Administration and Tools:** This module provides generic tools for administrating user accounts and databases.

(ii) For catering to the needs in During-Disaster Scenario

- **Incident Reporting System:** Incident Reporting System can be used by field reporting teams & district officials to report the data in a standardized format on different disaster events from any part of the country to senior officials in Government Departments.
- **Decision Support Systems for Relief and Rescue Management:** Information generated from the above modules in suitable formats (reports/tables/charts/maps/images) to enable the incident command or/ authority of the disaster affected area to decide on a responsible course of action. Various GIS and Remote Sensing application products shall be integrated as a part of tool library in this module. Various utilities/

tools shall be developed and included in this product library.

(iii) **For catering to the needs in the Post-disaster Scenario**

Resource Analysis and Emergency Relief:

The impact of the event needs to be balanced by resources, including funds, with the ultimate aim of a safe, stable environment. Effective hazard and vulnerability assessment will provide a series of pointers that indicate the type and location of resources that are needed.

NDMA portal along with the following four basic core modules are to be developed immediately. To develop the directory information and to implement the CUG Messaging system, a data collection format needs to be designed and published on the portal.

- Closed User Group Messaging System.
- Incident Reporting System of Disaster Event.
- Resource Analysis and Relief Needs.
- System Administration and Generic Tools.

6.7.2 Objectives of Application Development

The overall application development should focus to achieve the following objectives:

- i) Association among various stakeholders
- ii) Standardization of data
- iii) Automation of the operations
- iv) Resource sharing and
- v) Unified virtual environment to solve a complex DM problem.

Association: This refers to the active association among the various users involved in disaster management process. Such association is of both “vertical” type (within a particular department/organization), and of “horizontal” type (between different organizations).

Standardization: Standardization refers to disaster related reporting/ disseminating data. Such standardization would help develop a common and integrated database by using standardized data design with suitable coding schemes. In turn, this would help in providing a uniform access mechanism to all.

Automation: Automation refers to computer based tasks which can be done mainly through the computer with minimum human intervention. This would go a long way in eradicating many repetitive tasks, which are currently being done manually, thus eating up a significant portion of their precious time.

Resource sharing: Resource sharing refers to the sharing of computing resources covering computer hardware, software and also human skills and experience.

Unification: Unification denotes a virtual environment where different organizations/ departments go beyond their own limited boundary of operation and collectively try to solve the various complex aspects of the disaster phenomenon and thus, behave like a single unified virtual organization.

6.7.3 Approach to Application Development

Application development and implementation of the system is an iterative process and shall be carried out in phases

in consultation with various stakeholders. Application development/implementation requires domain knowledge as well as technical skills in the field of ICT. Further, the development team and the implementation team should work together to effectively address the requirements of disaster management. Software developers and end users should closely associate throughout the project life cycle.

Application development for disaster management is evolutionary in nature. Disaster planning is a continuous process that once started, has to be continually developed to relate to a moving target with ever changing patterns of hazards, vulnerability and resources. It is best conceptualized as cyclic process rather than linear process. Hence, Iterative and Incremental development approach is necessary. Application development/implementation requires software skills as well as domain expertise. It is important to maintain interactive relationship between the users and the developers throughout the development lifecycle.

Development of scheduling system indicating who will do what, when, where and who are to be clearly kept informed. This requires understanding the roles and responsibilities of various organizations at different levels (Sub-systems) who are involved in disaster management. A detailed information analysis study is essential to identify the roles and responsibilities. Provision should be made to record and analyze the coordination activities especially during a crisis. Logging of activities is essential.

Disaster Management Applications have to deal with unreliable communication

environments and low data transmission rates during a crisis. Decisions in the EOC are based on the information received from the rescue teams and the local bodies / NGOs working in the disaster affected areas. Rescue teams working in such situations, act on instructions issued from the EOCs. The decisions in the EOCs have to be taken quickly. The information from the field and the instructions from the EOCs are to be delivered fast. Reliability of information and the performance are the key issues to be addressed in the application design. Cyber Security and authentication of data are also important.

To meet the above requirements, the application design should be simple with very low application overhead.

Following are the major guidelines for development.

- Since various National and International organizations have already developed applications and databases for disaster management, their adaptability is to be critically reviewed. Based on their suitability, further improvements/development need to be evolved.
- Disaster Management Information System (DMS) development is cyclic process and hence iterative and incremental development/implementation approach is necessary.
- Fast response and reliability of the information are the key issues and the application development should address these issues.
- Application design should be simple with very low overhead.

- Open source technologies may be preferred for application development.
- NDMA may initiate development of low cost application tools to integrate Data services, Command and Control, broadcasting messages etc.
- Role and responsibilities of various stakeholders are to be clearly defined.
- Standardization of data is very vital.
- Since post disaster information plays an important role for incorporating improvements in overall planning system, proper collection and compilation of data (Damage data collection and estimation of losses) is most important.

6.7.4 Disaster Recovery (DR) Site for NEOC

The Disaster Recovery (DR) site for NEOC has been envisaged to be located outside Delhi away from NEOC in another geographical location probably in another State. The NEOC will be connecting to the DR site by redundant communication link with high bandwidth.

6.7.5 Database Requirements at National EOC

Databases are required at different levels namely at National, State, District and NDRF Operation Centres. Both map and attribute data are to be maintained at National, State and District Emergency Centres. At NDRF only attribute data shall be maintained. The map data shall be at the appropriate scale and contour intervals.

For disaster management applications, both spatial and non spatial data are essential at various levels of stakeholders for hazard zonation, VA&RA, mitigation, preparedness, emergency response and damage assessment.

In spatial domain, NDEM envisages to have a number of digitized layers on 1:50000 scale for entire country, 1:10000 scale for part of 312 multi-hazard prone districts and 1:2000 scale for 5 mega cities, relating to hazard zonation, transportation networks, settlements, natural resources, hazardous industries, resource inventories, etc.

- (i) Hazard mapping for different types of disasters along with different degrees of risk.
- (ii) Historical records of past disasters.
- (iii) Historical damage details.
- (iv) Historical details of relief fund spent (Event wise).
- (v) Climatic data (past rain fall data, wind speed records, sea surface and atmospheric temperature).
- (vi) Hydrological data (river flow records with dates and gauging station details, extreme flood limits and complete drainage information).
- (vii) Marine coastal data (tidal and surge records/charts with scales and dates as available and correspondence with coastal topography coastal geomorphology).
- (viii) Population census data (precise boundaries with topographic details for corresponding statistics).

- (ix) Agricultural census data (with dates, boundaries of census statistics, categories of statistical information, supplementary land use patterns).
 - (x) Buildings (locally relevant housing types, construction categories, hospitals, schools, broadcasting stations).
 - (xi) Epidemiological data sets (Details of epidemics with number of casualties and locational details and their relation with population census).
 - (xii) Roads (carrying capacities with engineering details of bridges, tunnels or cuttings).
 - (xiii) Railway stations & Airports networks: (locations and other technical details).
 - (xiv) Docks (technical transportation loading details).
 - (xv) Inventory of community coping mechanism (local leadership and skilled labour, community facilities, cash, credit, emergency goods and vehicles, local contingent plans etc.).
- Basin wise Hydrological data – river flow records with dates, gauging station details historically – extreme flood limits – complete drainage information.
 - Historical records of past disaster events with damage details and details of relief expenditure.
 - Census data sets.
 - Major National & State Highways along with engineering details of bridges.
 - Railway and AirPort Networks-stations locations and other technical details
 - Docks with transport loading details.
 - Inventory of essential and special resources and equipment with location details.
 - Country map with state and district boundaries, road, rail and river network-spatial data at the appropriate scale and contour intervals.

6.8 Applications and Database at the State EOCs

In addition to NDEM data base at national EOC, the following data bases are essential.

- Directory System Development (stakeholder contact details and their activities with role and responsibilities).
- National Communication network assets inventory.
- Neighboring countries, states and districts information.
- District wise different types of disasters along with degree of risk (Vulnerability details).

The State Relief Commissioner (SRC) functions as the nodal officer to coordinate the relief operations in the State. The SRC of the State shall establish an Emergency Operation Centre (Control Room) as soon as a disaster situation develops. SRC is assisted in discharging of his duties by the Additional Relief Commissioner and the Officers/Staff of Emergency Operations Centre.

The SEOCs and DEOCs function round the clock after the receipt of the information

about the occurrence of a disaster for a specific duration. The State and District Emergency Operation Centres have all information relating to the forecasting and warning of disasters, action plans for implementation and details of contact points and various concerned agencies. It shall have up-dated information of all resources and contingency plans for quick interaction during an emergency. The EOCs have the following responsibilities.

- (i) Transmitting the information to the NEOC regarding the crisis as a result of natural disaster on continuous basis till the situation improves.
- (ii) Receiving instructions and communicating to the appropriate agencies for immediate action.
- (iii) Collation and submission of information relating to implementation of relief measures to NEOC
- (iv) Keeping the state level authorities apprised of development on continuous basis.

The relief measures shall be reviewed by the district level relief committee (consisting of officials and non official members including the local legislators and the Member of Parliament).

6.8.1 Applications at State EOCs

Pre-disaster Systems

- Risk Analysis System
- Contingent Plan System
- Forecasting/Simulation & warning Dissemination System

During-disaster Systems

- Rescue & Relief System
- Damage Assessment & Fund Allocation System

Post-disaster Systems

- Restoration & Rehabilitation monitoring System
- Damage Analysis System

6.8.2 Database at State EOCs

- Directory information : Contact details
- State administrative boundary information
- Vulnerable districts
- Canal
- Transport network details (Road, Rail, Airport and Helipads)
- Infrastructure details (Details of medical facilities, Bridges, dams, River gauge stations, etc.)
- Block wise Rain fall details
- Past damage details
- State Contingent Plan data
- Neighboring States information
- IDRN inventory details
- Relief materials and shelter details

6.8.3 Stakeholders of State EOCs

- State Relief Organization
- Water Resource Department
- Central Water Commission
- India Meteorological Department
- State Government Line Departments

6.9 Applications and Database at the District EOCs

The District Collector is the focal point at the district level and assisted by Sub Divisional Officers, Tehsildars, Block Development Officers and Village Level Officers. In the wake of natural calamities, the District Emergency Operations Centre (EOC) shall be set up in the district for a day-to-day monitoring of rescue and relief operations on continuing bases.

6.9.1 Applications at District EOCs

Pre-disaster Systems

- Administrative Unit Module
- Disaster Risk & Vulnerability Module
- Directory Information module
- Resource (Contingency Plan) module
- Forecasting, Warning, Simulation Module

During-disaster System

- Alert Messaging module
- Incident Reporting module
- Rescue operations module
- Relief operations module
- Relief Management Module
- Damage Assessment & Fund Allocation System

Post-disaster Systems

- Restoration & Rehabilitation monitoring System
- Damage Analysis System
- Feed back and Control module

6.9.2 Database at District EOCs

Basic data is generated from the district and the flow is bottom up.

- Directory information : Various line departments contact details
- Habitation(Village/hamlet/ward) details
- Village wise different types of disasters along with degree of risk (Vulnerability details)
- Historical records of past events with damage details and details of relief expenditure
- Census data sets – agriculture census, population census, building and various structural details
- Resource information details (temporary shelters, food storage and emergency goods details, boats, hospitals, drinking water, generator sets, vehicles, etc)
- Block/Gram Panchayat contingency plans
- IDRN Inventory details
- Transport details : Road carrying capacities, bridges engineering details of tunnels or cuttings, Railway stations locations and other technical details, Airport and Helipad details
- Rescue team details
- Human Resource Contact & skill details
- NGO/Self help teams/ volunteer group details

- Donor details
- Health & epidemic information details
- District map with block and village boundaries

6.9.3 Stakeholders of District EOCs

- District Collector
- Line departments
- District Fire Station/Police
- Tahasildar at Taluk/Mandal
- BDO at Block/Panchayat Union
- Gram Panchayat
- Mobile Teams (Field reporting Teams)

- analysis and relief needs and system administration.
- ii) Development of application system at SEOC and DEOC.
- iii) Creation of database at SEOC and DEOC with information such as vulnerable districts, canal, relief material and shelter details etc.
- iv) Nomination of stakeholders (official and personal: whether governmental, public or ex-community).
- v) Maintaining stakeholders contact details: mobile numbers, land line numbers, E-mail address, official / residential address, in the form of a dynamically updated directory. These should also include details of officiating incumbents / next in chain of responsibility during absence of permanent incumbent.

6.10 Action Points

- i) Development of NDMA portal with modules for group messaging system, incident reporting system, resource

7

Facilities Provided at EOCs

7.1 Generic Requirements at EOCs

Emergency Operation Centres (EOCs) with requisite Static/Mobile Communication Access Platforms (SCAP/MCAP) at the back-end provide the work place and secured location to coordinate actions and undertake mission critical decisions at the time of emergency and disaster situations. The space adequacy (ergonomically and otherwise), functional requirements and back end connectivity along with desired power pack management are important for its effective functioning.

The size and complexity of the lay out and also, front end equipment would depend upon the level at which the EOC is supposed to be functioning. The EOCs at national (NEOC2 at NDMA and NEOC1 at MHA) and State level would have to be designed and operated nearly on similar lines. However, the EOCs for vulnerable districts and the Mobile Emergency Operation Centres for the NDRF Battalions would be designed and equipped in different configurations.

In a very generic sense, the EOCs at various levels should include the following components:-

- a) Operation Room is the main room where all disaster management operations are planned, managed and executed and would have components like LAN networked computers, Servers, Digitized Maps, Display Systems and Emergency Response Plans.
- b) Analysis Room at Data Centre in NEOC is meant for analysing the information received from other EOC operations room by the GIS experts, statisticians and data analysts so as to come up with a revised disaster management plan that could ensure speedy relief and recovery in the affected areas.
- c) Emergency Operation Centre (EOC) is also meant for the collection and dissemination of the disaster related information to the media and the general public. It would be equipped with requisite telephone network and a few computers / work stations as also related display systems. This would also update regularly the Call Centre Staff manning 'Help Lines'. Information Flow Diagram as related to EOC, is given at **Annexure 13**.
- d) Facility Centre should have equipment pertaining to documentation, photocopying, scanning, faxing etc..
- e) Communications Area (besides the available terrestrial or satellite based communications) would have radio communication on UHF, VHF, Low Band, HF and Amateur radio frequencies.

- f) Reference Library will contain research material to support the staff and personnel at the EOC particularly in the analysis room.
- g) Coordination Area is the WAN (Wide Area Network) connected room to be in contact with various centres of distribution of relief material such as back up transport systems, food and other materials, shelters in the area under the EOC, medical aid centres and list of hospitals and doctors, through its special cells that deal with those functions.
- h) At the back-end of each of the Emergency Operation Centres (EOCs), there would be a requirement to establish Static / Mobile Communication Access Platforms to use the Communication and IT equipment for inter / intra network connectivity.

While creation of EOCs would provide the workspace along with the front-end terminal facilities for control and coordination, the back-end Communication & IT connectivity support would be established in the form of SCAP for NEOC, SEOC, DEOC, and MCAP for MEOC and NDRF battalions. Essentially SCAPs and MCAPs would house the Terminal End Communication and IT Equipment as per the Communication and IT Support at respective levels. Terminal End Communication & IT Equipment would generally include Multi Service Platforms, Gateways, Satellite & VHF radios, Exchanges (Soft Switch types), NMS for dynamic network configuration, Bandwidth Management, Power Packs and so on. These Platforms will act as Communication Nodes / Points of Presence (POP).

7.2 Facilities at NEOC and SEOCs

NEOC and SEOCs would generally cater for the following facilities :

- a. INMARSAT Satellite phones - 2
- b. VSAT terminal - 1
- c. Laptops with encoding/ streaming card - 2
- d. Video / LCD based TV Screens - 5
- e. Projection system - 1
- f. Work Stations: NEOC - 10
SEOC - 5
- g. VOIP connectivity at National and State Level as Hot Lines via satellite as CUG
- h. IP phones - 10
- i. 100 lines (with telephones) EPABX connections at SEOC for DEOC connectivity
- j. Call Centre positions : 5 each at NEOC & SEOC
- k. Public Address system
- l. LAN with Servers to provide datacenter facility
- m. Wireless IP Phones : 10 at National Level and 5 at State Level.
- n. Routers- LAN switches-gateways-wireless access point for access and connectivity.
- o. Facility Centre comprising of heavy duty printer, photocopier, scanner and other office requisites like binding & lamination machine and so on.
- p. Power pack – Gen and UPS: Capacity 10 KVA & 8KVA
- q. Pantry, Wash Room & Rest Room for the EOC Staff.

7.3 Facility at Operational Control Room (OPS) at NDMA/MHA

will be established in NDMA Bhavan and NEOC will be linked to NDMA-OPS room through reliable redundant communication media. The OPS room setup of NDMA will be replicated in Ministry of Home Affairs (MHA) and it will be connected to NEOC through redundant communication link. The OPS room will be equipped with:

- i) Multiple screen wall mounted display - 1
- ii) Computer terminals - 4
- iii) Laptops with encoding/streaming card - 2
- iv) IP phones - 10
- v) Hotline: VOIP (Voice over IP) connectivity via satellite as CUG
- vi) Servers (about 10 GB capacity) - 2
- vii) LAN switch - 1
- viii) Router - 1
- ix) VSAT with equipment - 1
- x) INMARSAT SAT phones - 2

7.4 Facilities at DEOCs

The DEOCs would generally include the following facilities:-

- i) INMARSAT Satellite phones - 5
- ii) VSAT terminal - 1
- iii) Laptops with encoding/streaming card - 2
- iv) Workstations - 5
- v) Call center positions - 5
- vi) Projection System - 1
- vii) LCD based TV Screens - 3
- viii) IP Phones - 5

- ix) EPABX : 50 lines with requisite phones
- x) LAN with Servers to provide datacenter facility
- xi) Routers- LAN switches-wireless access point for access and connectivity
- xii) Hot Lines : VOIP (Voice over IP) connectivity via satellite as CUG
- xiii) Power pack – Gen and UPS: Capacity 10 KVA & 8KVA
- xiv) Public Address system
- xv) Connecting cables

7.5 For Incident Commander at Affected Site

7.5.1 ICT Needs at Incident Command System (ICS)

Studies confirm that response problems often relate to communication and management deficiencies, rather than lack of resources or failure of strategy and flaws.

In the context of communication support, what is required is an integrated communication platform in support of ICS. This would generally be based on the district level Mini Mobile Communication Pack (MMCP) and subsequently on the Mobile Emergency Operational Centre (MEOC) held with NDRF. The use of a common communication plan is essential for ensuring that responders can communicate with one another during an incident. Communication equipment, procedures, and systems must operate across jurisdictions (interoperably). Developing an integrated voice and data communication system, including equipment, systems and protocols must occur prior to an incident.

Effective ICS communications include three key elements:

- (a) Modes: The “hardware” systems that transfer information.
- (b) Planning: Planning for the use of all available communications resources.
- (c) Networks: The procedures and processes for transferring information internally and externally.

Depending upon regional and geographical complexities and also availability of local infrastructure, employment of hybrid communication technologies is most crucial. In such cases, quick deployment of wireless based communication support (satellite, cellular, radio sets and ham), in addition to terrestrial links, is fundamental for quick establishment and requisite mobility with adequacy of bandwidth for back-haul linkages.

7.5.2 Mini Mobile Communication Pack (MMCP) at the Districts Headquarters

Being the administrative authority at the local level, DC/DM has to move or nominate a person (except in the cases of Nuclear and Radiological Emergency where DC/DM himself has to take charge of the Incident Commander) to move to the site as the Incident Commander. It is also planned to provide transportable “Mini Mobile Communication Packs” (MMCP) to 312 Multi Hazard Prone (MHP), districts in the country, which on occurrence of disaster could be moved immediately to the disaster site (in a vehicle to be organized by DC/DM) under the affected district arrangements for restoring basic essential communications till the national level resources get deployed. Each Mini Mobile

Communication Pack will be equipped with the following Communication Equipment:-

- (a) Transportable (Flyaway)VSAT with IP phone - 1
- (b) Satellite phones (INMARSAT BGAN/INSAT) - 2
- (c) VHF Portable Radio (25W) - 1
- (d) VHF Sets (Walkie Talkie types) - 20
(to be used by incident commander & Local authorities at site)
- (e) Laptop with encoding/streaming card - 1
- (f) Genset 2 KVA - 1
- (g) Spare 12V 75AH battery for portable VHF set - 1

7.6 At NDRF Headquarters (Base Camp)

- i. Work Stations - 3
- ii. LCD Panels - 2
- iii. Cable TVs with LCD Monitors - 2
- iv. Dish TVs - 2
- v. 25 lines(with telephones) EPABX - 1
- vi. IP phones - 2
- vii. VSAT satellite terminal - 1
- viii. Satellite phones (INMARSAT BGAN/INSAT) - 2
- ix. Mobile handsets with CUG (Closed User Group) connection - 160
- x. LAN switch - 1
- xi. Genset 10KVA - 1
- xii. UPS 8 KVA - 1

Other Peripherals

- a) Fax Machine - 1
- b) Scanner - 1
- c) Photocopier - 1
- d) Laser Printer - 1

7.6.1 Facilities at Mobile Emergency Operations Centers (MEOCs)

Each of the 10 NDRF battalions will be provided with a vehicle based. Mobile Communication Access Platform (MCAP) equipped with communication equipments for effective employment in disaster situations to operate as MEOC. At base camp, certain provisions have been made for communication so that integral communication support is available for their internal command, control and administrative functions also. Layout of MEOC is furnished at **Annexure 14**.

The primary objective is to provide fail-safe communication thru wireless medium at disaster site for communication among the company, team and sub-teams (as shown in **Annexure 15**). The primary mode of communication uses satellite and VHF system as shown in the diagram in **Annexure 16**. Tactical Headquarters is provided with a specially built vehicle based mobile communication system completely wired and ready to use condition. The details of equipment requirements are furnished at **Annexure 17**.

Full details of the Equipment Profile for each NDRF battalion are given as under:-

7.7 At Tactical Headquarters of NDRF Commander

To augment the bandwidth available at site, MEOC from the nearest NDRF battalion would be moved to site with specially built vehicle-based mobile communication system completely wired and in ready-to-use condition having the following equipment:-

Satellite	
i. Satellite phones (INMARSAT BGAN/INSAT)	- 2
ii. Vehicle mounted VSAT	- 1
iii. Transportable (Flyaway)VSAT	- 1
VHF	
i. Portable Radio(25W)	- 1
ii. Base Station (25W)	- 1
iii. Walkie-Talkies (WT) (5W)	- 5
Peripherals	
i. Hotlines : IP phones via satellite as CUG	- 10
ii. Laptops with encoding/streaming card	- 2
iii. Handycam	- 1
iv. LAN switches	- 2
v. Genset5 KVA	- 1
vi. UPS 2KVA	- 1

7.7.1 For Companies/Teams/Sub-teams (distribution shown in Annexure 17)*

Satellite	
i. Satellite phones (INMARSAT BGAN/INSAT)	- 6
ii. Transportable (Flyaway)VSATs	- 6
VHF	
i. Walkie-Talkie (WT) (5W)	- 210*
ii. Base Station (25W)	- 24
iii. Portable Radio*(25W)	- 6
iv. Repeater (Extended coverage)	- 6
Peripherals	
i. Laptop with encoding/streaming card	- 6
ii. IP phones via satellite as CUG	- 12
iii. Handycam	- 6
iv. LAN switch	- 6
v. Genset 2 KVA	- 6

- vi. UPS (2KVA) - 6
- *Additional WT's required by local authority included

7.8 Action Points

- i) Finalisation of the needs of MEOC with satellite communication for connection outside the disaster site and VHF for connection within the disaster site.
- ii) Planning for new technology equipments such as portable Microcellular system, Tetra system, Generic RF repeater system, WiMAX, rapidly deployable Wireless Mesh

Network for the disaster situation can be taken up depending on the experience gained in the utilization of the equipments planned and supplied as detailed in this chapter.

- iii) Planning for transportable microwave link /optical fiber systems as temporary measure for connecting to the nearest town for access to national network by the State Governments by entering into an arrangement with the service providers in the area.
- iv) Establishment of Emergency Operation Centres at State and District levels with requisite facilities

8

Technological Challenges for Implementation of NDCN

8.1 Introduction

Close scrutiny of the role of ICT is essential to clearly bring out the challenges towards establishment of an effective and responsive National Disaster Communication Network (NDCN). Some of the key challenges are discussed in brief in the succeeding paragraphs.

Disparities in Communication and Structure: In ground reality, India is a Sub-Continent by itself. Infrastructural development in the field of ICT varies from region to region especially in the context of mountains, high altitude and coastal terrain where the ICT infrastructure is yet to develop fully. In addition, different technologies at different points of time are placed for infrastructural support. Therefore, on a national level, existence of such disparities in communication infrastructure calls for planned and conscious integration of existing functional as also emerging technologies in the field of ICT.

8.2 Innovative Approach to Remove Existing Gap:

A dedicated large and complex Communication and IT structure in support of Disaster Management in phased manner to

be established clearly calls for an evolutionary approach. Some of the fundamental issues, which impact the implementation of this network of networks are :

- i) Full scale utilization of existing ICT infrastructure (governmental / private) as existing today and requisite integration with the proposed modern ICT Architecture. The aim should clearly be to cover the gaps while keeping in mind the futuristic requirements.
- ii) The implementation should be centralized to avoid any interoperability, information sharing and integration issues. It, therefore, becomes evident that NDCN Architecture should be centrally engineered, managed and controlled.
- iii) The infrastructure built up and software generation, implementation and upgradation should be carried out concomitantly. It is this facet, with related application sensitive requirements for DM, which needs very clear understanding and focused implementation particularly at National/ State/District levels.
- iv) The security issues for protocol based information sharing and dissemination would need special care and emphasis

during integration of SWANs and “Stand Alone” early warning / forecasting networks with the planned NDCN Architecture.

- v) Architecture must be open ended and non-blocking so as to cater for futuristic addition, expansion and alteration. At no stage, it should be engineered on proprietary based technologies

8.3 Restoration of Full Bandwidth Available

Consequent to disaster, whatever infrastructure does survive, must be fully exploited with desired levels of innovation and support from the community as well as local Service Providers (in the field of terrestrial networks, cellular networks and internet provision). In the aftermath of a disaster, the live Points of Presence (POPs) need to be integrated with mobile transportable networks engineered by NDMA. This also includes integration of **ham radios** and any other communication resources, be it from para military forces, police or defence forces. In addition to deployment of Mobile Communication Platform effort should be intended to restore the damaged infrastructure so that full bandwidth is available for response, damage assessment and reconstruction work.

8.4 Language Barrier

This is a major challenge in effective application of technologies across the Indian Sub-Continent, which has a large number of regional languages. This would require a

combinational approach of high tech as well as practical and down to earth societal / human based systems, especially in the case of early warning and forecasting systems.

8.5 Creation of Call Centres and Websites (Multi-lingual)

Establishment of Call Centres and Websites (multi-lingual) will be major assets for effective DM as also public awareness and media support.

In today’s context, establishment of a Call Centre based ‘Helpline’, particularly at District and State levels and also, at National level will be of key help and support during management of live disasters. Help-lines (during routine functioning) can be used for E-Governance purposes and during management of disasters these can be duly beefed up for Disaster Management and these would have to be multi-lingual i.e. English/Hindi/state specific language.

Creation of multi-lingual Websites at the National and State levels would also go a long way in ensuring the right Disaster Management support and environment.

8.6 Requirements of NDMIS

For effective management of the Disaster in the entire Disaster Management Continuum of the National Disaster Management Information Systems (NDMIS) with requisite data fusion centre at the National level and data centres at State and District levels at respective EOCs and also, mobile data centres with the NDRF are to be met.

8.7 Communication Build-up in Graded Manner

The communication build-up is to be carried out in a graded manner. This requires uninterrupted voice, data and video transmission with built-in broadcast capability.

In effect, therefore, what we need to ensure is to build and deploy emergency ICT systems with desired scaling from routine day to day operations to time sensitive Disaster Management, till total restoration of ICT support in the disaster affected area. Therefore, it is important that we exploit redundancy and diversity to achieve this resilience.

The crux of the matter is the design of ICT systems with desired flexibility, architectural lay out and interoperability as the key guiding principles. The aim should be to utilize not only integral governmental systems, but also any functional and available systems: (whether governmental or private) and in any mode, whether wireline or wireless.

8.8 Logistic Support and Maintenance of NDCN

Establishment of NDCN involves complex array of hardware and equipment spread over the complete Indian Sub Continent. Operation and maintenance of such network would have related implications with regards to Logistic Support and Maintenance in terms of spares, fuel, mobile platforms, software updation and so on.

The key constituents pertaining to desired Support Measures evolve around establishment of Emergency Operation Centres (EOCs), Static

and Mobile Communication Access Platforms, manning pattern, network security, software support and related applications simulation and modeling, data base built-up and regular updating, network, logistic support, power pack management and so on. Requisite training for HR development, community awareness and specific disaster based simulation and modeling are a few more areas of equal concern. Well documented and regularly updated Standard Operating Procedures (SOPs) and related check lists are key to effective response for Disaster Management.

Infrastructural establishment and subsequent 24 X 7 basis availability with desired responsiveness requires proper planning and implementation with on-ground available Support Measures. It is not only the initial NDCN set up (which is fundamental to Disaster Management,) it is its subsequent round the clock maintenance, security, availability and dynamic upgradation in an evolutionary manner and in tune with the emerging technologies which is of fundamental importance. There are a host of measures and support imperatives, which have to be well conceived and put in place for utilization of established NDCN infrastructure. Its effective usage needs to be looked at from the users functional requirements; whether during routine functioning or during management of live disasters, on occurrence of which these very systems have to be re-engineered, operated, maintained and in effect fully utilized as mission critical systems.

Establishment and subsequent 24x7 availability of NDCN on continued basis with the desired responsiveness requires planned and

on ground available support measures. Some of these in brief are enumerated below:-

- (i) Assured Availability of minimum skeleton operational organization for necessary Network Management Control and dynamic reconfiguration wherever required.
- (ii) Network logistic support separately for technical maintenance and regular operation and testing of standby Communication and IT equipment.
- (iii) Training and Continued Education of users and Management / Control staff / Data Administrators. This is going to be a major HRD issue for DM work.
- (iv) PowerPack Management including 24X 7 backup both for Static Communication Access Platforms (SCAP) and Mobile Communication Access Platforms (MCAP). Prolonged durations would dictate provision of diesel generator sets of adequate capacity, desired levels of fuel stocking/movement and also, charging back-up batteries for communications and allied equipment. Non-conventional sources of power such as solar cells, wind mills can also be planned.
- (v) Application based Software with particular reference to DM and creation of associated forms and formats.
- (vi) Ensuring Network system security, harmonizing and media support.
- (vii) Dynamic and regular database updating.
- (viii) Protocol based Data Sharing. Appropriate data mining and storage tools along with simulation platforms assume importance.
- (ix) Issues as regards Spectrum / Frequency Allocation (Radio & Cellular Networks and SAT phones) and management would have to be resolved with Wireless Planning Commission (WPC).
- (x) Memorandum of Understanding (MOUs) and Service Level Agreements (SLAs) with various Service Providers; or issue of "Communication Support Directives" through the licensing policy route.

8.9 Action Points

- (i) Establishment of Call Centers and multi-lingual web sites at District, State and National level.
- (ii) Working out host of measures and support initiatives such training, logistic support for maintenance, power backup especially at the disaster site, issues regarding spectrum/frequency allocation and data updation for the establishment of NDCN.

9

Technology, Emerging Trends and R&D Requirements

9.1 Introduction

Establishment of infrastructure is not really a onetime process; this in fact is a continuous and evolving process. While building up the National Disaster Communication Network (NDCN), which will act as the take off point for effective induction of ICT for Disaster Management (DM), Planners at the National and State level need to first understand telecommunication technology and ICT requirements in totality for effective implementation and use of NDCN.

On one hand, exploitation of emerging technologies with state of the art next generation networks along with plethora of software applications on the horizon is absolutely fundamental for management of DM Continuum, it is equally important on the other hand that stakeholders involved in the DM at various levels understand these wide range of available technological platforms in generic terms, so as to apply them for effective DM supports. It is in this context that in this Chapter, it is aimed to cover, in very generic terms, the Emerging Technological Backdrop.

In this chapter, the outline of basic telecommunication principles such as switching, multiplexing, etc., which are consistently applied in the modern telecommunication networks, are

introduced first. Then, a look at various network technologies such as mobile network, satellite network etc is taken. As rapid technological advances are at the horizon, a brief sketch of emerging scenarios in the subsequent section is also given. Finally, a section on R&D follows, as no chapter on telecommunication and ICT can be complete without touching upon R&D efforts, because innovation brings lot of new features, which are essential for improving DM with progressively more efficiency and reduced time frame in various phases of natural disasters.

9.2 Multiplexing and Modulation Techniques for Increased Traffic Carrying Capacity

Telecommunication system consists of three main components: viz (i) the information, (also called baseband), (ii) the medium and (iii) the carrier.

Information can be voice, data or video signals and can be in two forms, analog or digital. Analog signal is considered continuous, on the contrary, digital signal is non-continuous characterised by two states "1" or "0" (indicating presence or absence of a voltage for example). Voice is analog in nature, where as data is digital in nature. Since modern telecommunication

networks are digital, voice is invariably coded as '1' & '0' for its transmission in the network.

The medium is the entity the signal travels through. It can be air, space, copper wire or optic fiber. Each of these media offers its own unique set of advantages and distortions, that determine the nature of the carrier used.

Carrier, as the name suggests, carries the information thru the medium to be delivered at the other end. If 'medium' is compared to the road travelled, the 'carrier' is the truck that carries the 'information' (goods)). Depending on the medium, the carrier will have a frequency appropriate to the medium. It can be at light frequency (as in optical fiber) or a microwave frequency (as in mobile communication).

In order to increase the traffic carrying capacity in the telecommunication network, various multiplexing techniques are employed. There are different modulation techniques used in the network for the information to be sent on the carrier.

Various multiplexing and modulation techniques adopted are furnished in detail in the **Appendix-III**.

9.3 Convergence of Voice, Video and Data Services

Traditionally the telephone network (now termed as telecommunication network) has been catering to the needs of voice telephony alone, (providing interconnection between various customers) for speaking to each other and the collection of interconnected systems (operated by the various telephone companies and administrations around the world) is called Public

Switched Telephone Network (PSTN). It is also known as the Plain Old Telephone System (POTS). Generally, PSTN refers to voice connectivity. The PSTN started as human-operated analogue circuit switching systems (plug boards), progressed through electromechanical switches. Now the pure telephone network has transformed into a telecommunication network capable of carrying services other than voice. With rapid technological advancement, digital switches have formed part of the network, initiating the first step towards the convergence of voice and data by introducing Integrated Services Digital Network (ISDN). A brief description about ISDN is provided in **Appendix V**. The requirement of the network to carry telecom traffic has increased enormously in the recent years. Internet has added a new dimension to the services being deployed in the network.

The convergence of voice and data has been achieved with the technological advancement that has taken place in bottom layers of OSI model (details of OSI model given in the **Appendix IV**).

The network has been transformed into a multiservice network to carry voice, data and video, thanks to the developments such as packet switching, VOIP, MPLS and so on.

These technological developments have been elaborated in detail in the **Appendix-V**.

9.4 Telecommunication Network Technologies

9.4.1 Satellite Communication Network

Establishing communication with remote areas has been a great challenge and with the

advent of satellite communication in the early sixties, the problem of connectivity to remote and far flung areas has been resolved. Satellite communication provides the facility of covering areas (national and international) using one or several satellites. Low Earth Orbit (LEO) satellites orbit around earth at a distance of few hundred kilometers providing the facilities of remote sensing etc.

For telecommunication purposes and TV broadcasting, geo-synchronous satellites (GEOs), which orbit at a distance 36000 kms around the earth, are used. Low Earth Orbit (LEO) and Medium Earth Orbit (MEO) satellite systems orbit at much closer distance (few hundreds to few thousand kms). However, the position of the satellite in this orbit is continually changing with respect to earth, they require several satellites in their constellation for linking to ground earth station and providing continuous communication services. Similarly, since each satellite serves a smaller area of earth's surface, several earth stations need to be established. They have, therefore, been not popular for communication purposes.

Communication satellites (GEO satellites) are launched at an altitude of about 36000 kilometres around the equator in the geo-synchronous orbit so that the movement of the satellite matches with the rotation of the earth. This enables pointing of earth station antenna towards the satellite for receiving the signal continuously (as the satellite appears as a stationary object).

Communication satellites are usually designed to have a typical operating lifetime of 10 to 15 years. They operate on different

frequencies for uplink (earth station to satellite) and downlink (satellite to earth station). Since higher frequencies suffer higher propagation loss and there are limitations on the power output from the satellite (due to constraint on overall weight), the earth station transmits at higher frequency (uplink) as the earth station can compensate the higher propagation loss with higher power output. Hence, uplink frequency is higher than the downlink frequency. Uplink and Downlink are also referred as Transmit and Receive frequency respectively.

Satellite communication systems are dominated by the need to receive very weak signals. In the early days, very large receiving antennas at the earth stations with diameters upto 30 metres were required. As more heavy and powerful satellites are launched nowadays, much smaller earth station antennas have become feasible.

Satellite systems operate in the microwave and millimeter wave frequency bands, using frequencies between 1 and 50 Ghz. Above 10 Ghz, rain causes significant attenuation of the signal and the probability that rain will occur in the path between the satellite and an earth station must be suitably factored into the system design.

The frequency bands of operation are denoted by uplink frequency/downlink frequency and bands currently used are: predominantly C-band (6/4 Ghz) and Ku-band (14/11 Ghz) with a few services in Ka-band (30/20 Ghz). Ku and Ka-band enable use of smaller diameter antenna (typically less than 1.5m), narrower antenna beams and better control of coverage patterns compared to C-band. Maritime services use

C-band for shore station and L-band (1.5 Ghz) for ship terminals.

Each satellite contains several transponders which basically do the function of frequency conversion (uplink to downlink frequency) and amplifying the weak signal received at the satellite after travelling about 36000 km.

Typically, each transponder supports 36 Mhz , 54 Mhz or 72 Mhz (depending on the design) and the available total bandwidth is typically 500 Mhz for each of frequency band (C, Ku and Ka bands) of operation. Large GEO satellites also use both the C-band (6/4 Ghz) and Ku-band (14/11 Ghz) for providing more bandwidth. Further increase in bandwidth is also possible by frequency reuse and polarization i.e. polarizing the same carrier in LHCP (Left Hand Circular Polarisation) or RHCP (Right Hand Circular Polarisation) in order to nearly double the bandwidth.

Two modulation techniques are in use in satellite communication system: viz Frequency Modulation (FM) and Phase Shift Keying (PSK). In FM, the frequency of the carrier is changed in accordance with the amplitude of the information signal. FM is widely used in analog system. As present, day satellite systems widely use digital transmission techniques and baseband consist of digital bit stream, PSK technique is used for modulating the digital signal.

Satellite communication, being essentially broadcast in nature (in addition to its use in interactive mode), provides direct access to many terminals(users) simultaneously in its coverage area with the same quality (which is referred to as "multiple access" feature). This is the distinct advantage of satellite

communication when compared with terrestrial and landline communication, *in addition to its* high reliability with the absence of problems related to last mile connectivity.

Three basic multiple access techniques viz; FDMA (Frequency Division Multiple Access), TDMA (Time Division Multiple Access), CDMA (Code Division Multiple Access) where the baseband signal (information) from various users are differentiated by frequency, time and code respectively are described in **Appendix-III**. Multiple access enables users to share the same transponder bandwidth by directly accessing the satellite more efficiently by transmitting the signals (voice, video, data) from the earth station using one of the multiple access techniques. The baseband can be based on one of the multiplexing techniques and it is modulated using a modulation technique.

However, for digital baseband, digital modulation techniques need to be used. In general one of the multiple access techniques (FDMA/TDMA/CDMA) is used for connecting several users/terminals in the satellite network.

The primary advantage of satellite communication is the ease with which it can be used for emergency communications, disaster management etc. Other applications are: remote area communication, weather forecasting, TV broadcasting, mobile communication etc.

A typical satellite network consists of a Hub and VSATs (Very Small Aperture Terminals) as shown in the figure below. Hub is a central station where all the signals from VSATs are integrated and their connectivity with other networks is established.

VSATs are located at the customer premises and these are invariably fixed terminals providing multiple connections for voice, video and data including LAN for a particular location.

On the other hand, handheld satellite phones/ briefcase terminals (like INMARSAT sat phones) provide direct connectivity to the satellite alongwith mobility (as it is easy to carry extending voice and data and, in some cases, video facility for individual users). However, use of mobile satellite phones services involve very high recurring expensive call charges (though the capital charges are much lower) compared to call charges of satellite services provided by fixed VSAT terminals (which incur high investment cost compared to satellite phones).

DAMA (Demand Assigned Multiple Access) mode of working for SCPC terminals became popular wherein, there is no permanent carrier assignment to each satellite terminal. In DAMA, a pair of carrier frequency to a terminal is assigned from Hub on demand basis. When a terminal intends to communicate, a request message from the terminal is automatically sent in random transmission mode on a common carrier shared by all the terminals. The request message contains the originating terminal number and type of service. DAMA server at Hub receives the message through satellite, allots free satellite channel (a frequency pair) if available and sends allocated satellite channel number in the return common broadcast channel. When the calling terminal receives the allocation message meant for it, it tunes it's transmit and receives frequency corresponding to the allocated channel pair and begins the communication.

Satellite based Network

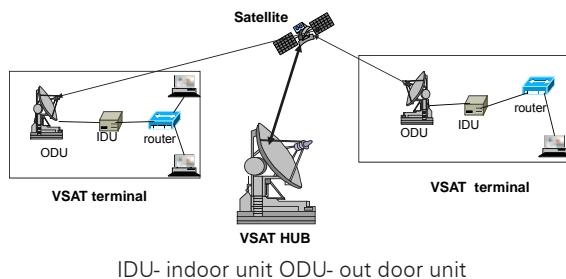

9.4.1.1 Single Channel Per Carrier (SCPC) is a method employed to connect remote places with low density of traffic using satellite communication.

A carrier is permanently assigned for each satellite terminal and it is connected to other terminal on a point-to-point basis. A pair of carrier frequency assignment is essential for each terminal for transmit and receive. In order to conserve the frequency spectrum,

SCPC is employed for providing access to remote stations with low traffic in a cost effective manner, as terrestrial systems may not be economically viable due to remoteness.

9.4.1.2 Very Small Aperture Terminal (VSAT)

VSAT technologies have found applications in several scenarios where seamless communications are required. There are several limitations faced by terrestrial lines in reaching remote and other difficult locations. Uptime of upto 99.5 percent is achievable on a VSAT network. The deployment takes no more than 4 to 6 weeks. A single point contact for operation, maintenance, rapid fault isolation and troubleshooting makes things very simple for a client, using VSAT services. VSAT networks

offer enormous expansion capabilities. This feature factors in the changes in the business environment and traffic loads that can be easily accommodated on a technology migration path. Additional VSATs can be rapidly installed to support the network expansion to any site.

Internationally, Ku-Band is a popular frequency band in use. The Ku- Band by virtue of its higher frequency can support traffic with smaller antenna sizes in comparison to C / Ext-C Band. The various frequency bands are as below:

Frequency Band	Uplink (Ghz)	Downlink (Ghz)
C Band	5.925 to 6.425	3.700 to 4.200
Extended C Band	6.725 to 7.025	4.500 to 4.800
Ku Band	14.0 to 14.500	10.950 to 11.200 &
		11.450 to 11.700

Satellite based VSAT communications have been known to be advantageous to link geographically remote and environmentally harsh locations. The range of coverage for satellite based communication system is relatively very large and independent of terrestrial conditions.

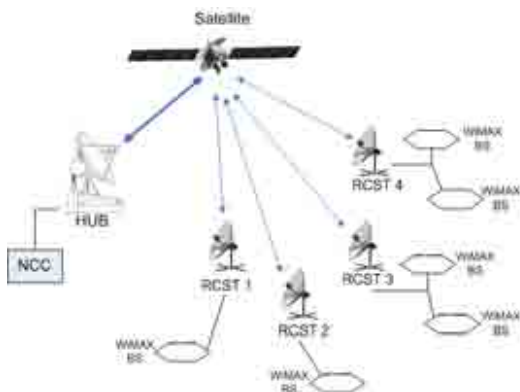

RCST - Remote Communities Services Telecentre
 NCC - Network Control Centre
 BS - Base Station

9.4.1.3 Satellite Phones

Satellite phones are the mobile handsets accessing the Satellite or accessing through a portable terminal (briefcase type).

Among the various satellite technologies, INMARSAT BGAN (Broadband Global Area Network) service is accessed via a small, lightweight satellite terminal that can be quickly and easily connected to the laptop PC and voice handset. They are designed to suit single user whose primary concern is portability.

All terminals are robust and able to withstand challenging environments and extremes of temperature. INMARSAT BGAN System provides voice, data, streaming video services with aggregate bit rates upto 492 kbps to remote users (User Terminals) via satellite link (INMARSAT-4 satellites). A typical BGAN system is shown below.

Due to nonexistence of BGAN gateway in India, use of BGAN terminals in India needs special permission from Department of Telecommunications as per the existing policy guidelines.

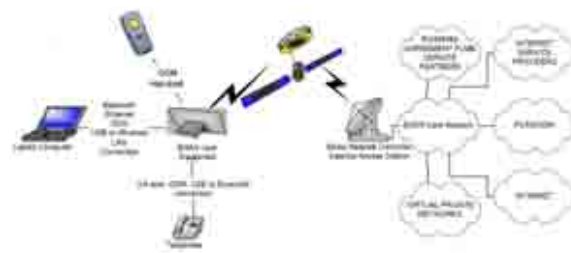

- Hub to satellite works in C-Band as shown below:
 - Uplink to the satellite: 6425 - 6575 Mhz,
 - Downlink from the satellite: 3550 - 3700 Mhz

- Transmission between the satellite and mobile users is via the L-band 'user link'. Frequency range:
 - Uplink to the satellite: 1626.5 - 1660.5 Mhz
 - Downlink from the satellite: 1525 - 1559 Mhz

9.4.1.4 INSAT MSS Type- D System

Space Applications Centre (SAC), of ISRO (with active participation of Indian industries) has developed a small portable satellite terminal that works with INSAT Satellite for voice/data communication. The INSAT satellite contains specialized Mobile Satellite Transponder by which communication through a small terminal is possible. The terminal was developed keeping its primary use for voice communication during disaster when other communication means are likely to have broken down. It can be used from any location in India for emergency communication.

The portable Satellite terminal at a remote place can be connected through the satellite to an EPABX at the Hub. In this way, a remote place can be linked as one of the extensions of EPABX and telephone calls can be made between portable satellite terminal at the remote site and local phones connected to the EPABX.

The Central Hub station uses a 6.3m-antenna system. It transmits and receives frequencies in C band. The portable satellite terminals transmit and receive frequencies of the terminal is in S band.

The satellite channel works in DAMA (Demand Assigned Multiple Access), where, a pair of satellite channels is assigned from Hub to a terminal on demand basis. When a person lifts the telephone handset to make

a call, a request message from the terminal is automatically sent in random transmission mode on a common carrier shared by all the terminals. The request message contains the originating terminal number and type of service requested for. DAMA server at Hub receives the message through satellite, allots free satellite channel (a frequency pair) if available and sends the allocated satellite channel number in the return common broadcast channel. When the calling terminal receives the allocation message meant for it, it tunes it's transmit and receives a frequency corresponding to the allocated channel pair and gets a dial tone from the exchange, subsequently. It is like the connection to EPABX exchange directly (even though it is through satellite). The person can then dial a desired terminal number/EPABX number and communicate with the called party. Similarly, local user can also contact any satellite terminal.

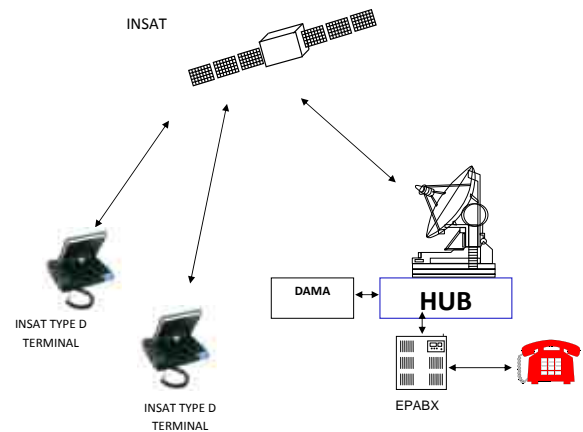

9.4.2 DTH (Direct-To-Home)

Direct Broadcast Satellite (DBS), is a term used to refer to satellite television broadcasts intended for home reception, also referred to more broadly, as Direct-To-Home (DTH) signals.

The expression direct-to-home or DTH was, initially, meant to distinguish the transmissions directly intended for home viewers from cable television distribution services that sometimes carried on the same satellite. The term predates DBS satellites and is often used in reference to services carried by lower power satellites which required larger dishes (1.7m diameter or greater) for reception. The direct-to-home (DTH) market in India has evolved considerably over the past four years with the entry of private players. DTH can apply to several services transmitted over a wider range of frequencies (including standard Ku-band and Ka-band). It shares characteristics with VSAT, since it is also satellite based. The main point of differentiation with VSAT services is that DTH primarily allows only one-way or broadcast communication. Two ways full duplex communication would require special equipment and infrastructure.

9.4.3 Optical Fiber Communication (OFC) Networks

The advent of optical fiber technology has changed the dynamics of telecommunication networks. It has provided solution to the bandwidth limitations imposed by other modes of communication, viz copper cable, microwave and satellite, and it offers large bandwidth capacity at an economical price. Optical fiber communication has wide ranging applications in local and long distance communication. The economics of optical networking has already resulted in its total dominance of long-distance segment of the global terrestrial and undersea communication network. With exponential advancement of optical technology, its value proposition has equally become compelling

even for shorter distance applications and the optical network has steadily advanced moving to the customer prices for high bandwidth applications.

The baseband is formed in OFC networks using SDH (Synchronous Digital Hierarchy) standard, which provides high bit rate up to 10 gigabits (for details refer to **Appendix –III**). The baseband (electrical signal) is converted into optical signal using lasers and transmitted over the optical fiber.

Rapid developments in optical technology has brought a revolution to modern day networks with the capability to carry terabits of data employing Dense Wave Division Multiplexing (DWDM) technology, which has increased the capacity of a single strand of fiber by several fold.

DWDM makes it possible to carry the entire global traffic (including telephone calls, emails, Web page down load etc) using optic fiber communication. With the deployment of Optical Cross Connects and Optical Add-Drop Multiplexers, wavelengths of light can be added to or dropped from the optical fiber en route between the main hubs. It allows the end user to access wavelengths of light from the optical network directly thus providing enormous bandwidth for various services such as internet, IPTV, voice etc.

9.4.3.1 Propagation Modes through Optical Fibers

Optical fiber, as optical waveguide, can propagate in several modes depending upon their physical structure. Depending upon the propagation properties, optical fibers are classified as single mode and multimode

fibers. As the name suggests, single mode fibers support only one mode of propagation, while multimode supports several modes. The multimode propagation result in modal dispersion and modal noise as result of interaction between the modes and it limits the transmission carrying capacity of the fiber.

Hence, single mode fibers are used for telecommunication purposes as it avoids the deficiencies due to multimode and it can carry signal at a much higher speed than multimode fibers.

As the light travels through silicon fibers, it suffers loss (attenuation) of signal strength from two controlling factors viz Raleigh scattering and IR absorption. For all telecommunication requirements, single mode fibers operating in 2nd window (1330nm) and 3rd window (1550 nm) are used, as the attenuation at these wavelengths are lowest as can be seen from the diagram below;

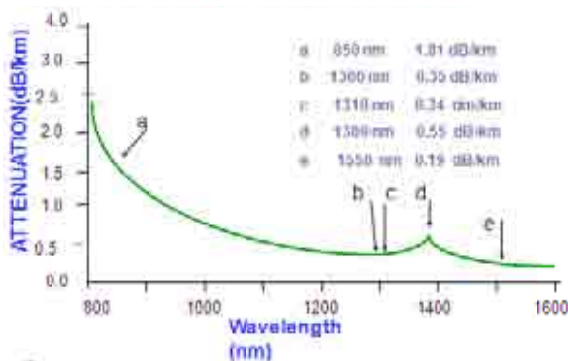

9.4.3.2 Dense Wave Division Multiplex (DWDM)

DWDM is a technology where incoming signals (lamdas) are multiplexed by assigning different optical wavelength to each incoming signal & simultaneously, transmitting all of them over a single fiber.

With the rapid advancement in optical fiber technology, DWDM has provided terabits of bandwidth capability as well as bit transparent medium over optical fiber links.

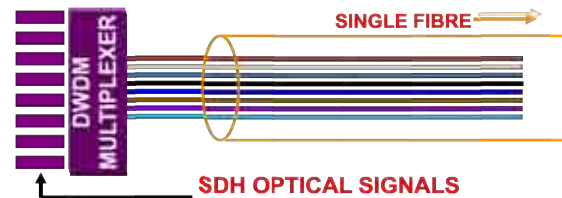

DWDM provides bit rate and format independent (transparent) paths. It ensures transport of all types of signals as shown below:

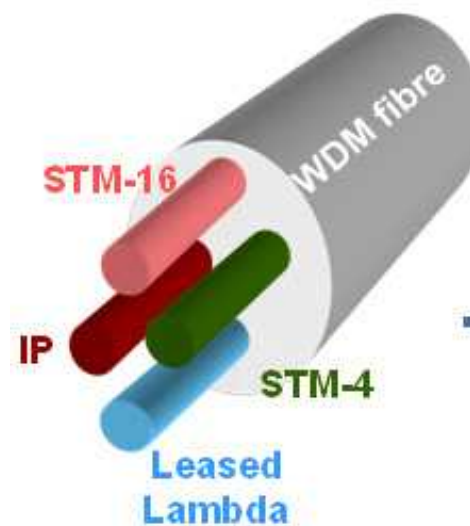

9.4.4 Signal Transmission and Mobile Communication Technologies for Cellular Service

Signal Transmission

For the purpose of efficient communication, transmitted signals (voice, video and data) are to be carried through a carrier radio frequency (with minimum possible bandwidth of the frequency spectrum, bandwidth being a scarce resource) to

the destination. One of the basic objective in data communication is to allow several transmitters/users to send voice /data simultaneously over a single communication channel of given bandwidth without causing interference. In other words, all communication technologies have to solve the same fundamental problem of dividing the given RF spectrum amongst multiple users as efficiently as possible. This task of channel access in radio-communication is realized through the concept of channel access/ multiple access, utilizing various modulation/multiplexing techniques like TDMA (Time Division Multiple Access), FDMA (Frequency Division Multiple Access) and CDMA (Code Division Multiple Access).

In theory, TDMA, FDMA and CDMA have the same spectral efficiency but in ground reality each has its own challenges (e.g., control of timing in TDMA power control frequency generation/filter in FDMA and CDMA) and resulting deviation from theoretical efficiency.

Time Division Multiple Access (*TDMA*) divides the access by time, and hence the data communicated is not continuous, but the time gap between two bursts of communication is too small to affect quality. In fact, TDMA uses different time slots of transmission and reception of data. TDMA systems must carefully synchronize the transmission times of all the users to ensure that they are received in the correct timeslot and do not cause interference. Since this *cannot be perfectly controlled in a mobile environment*, or user mobility, each timeslot must have a guard-time, to reduce the probability of users interfere, at the cost of decreases in the spectral efficiency.

Frequency-Division Multiple Access (*FDMA*) divides the access by frequency. FDMA systems must use a guard-band between adjacent channels, due to the unpredictable doppler shift of the signal spectrum, in case of user mobility. The guard-bands will reduce the probability adjacent channels interfere, at the cost of spectral efficiency.

In CDMA, spread-spectrum technique is adopted for the access where the signal generated in a particular bandwidth is deliberately spread over the entire frequency band. Each group of users is allotted a shared code in the spread-spectrum and many codes occupy the same channel, each channel (code) being overlaid on the top of one another. Only the users assigned with a particular code can communicate amongst themselves resulting in uses of the transmission bandwidth several orders of magnitudes greater than the minimum signal bandwidth required. Spread spectrum techniques were initially used for military applications because of its security and resistance to jamming, to prevent detection (because jamming signal has only a finite amount of power available that can either be spread over the entire bandwidth of the signal to be jammed or can jam only part of the entire signal) and to limit power flux density (e.g. in satellite downlinks).

An analogy to the problem of multiple access is a room (channel) in which people wish to talk to each other simultaneously. However, to avoid confusion, people are asked to take turns while speaking (time division) or speak at different pitches (frequency division), or speak in different languages (code division). CDMA

is analogous to the last example where people speaking the same language can understand each other, but other languages are perceived as noise and rejected.

The figure below shows how spread spectrum signal is generated. The data signal with pulse duration of T_b is XOR'ed with the code signal with pulse duration of T_c (Note: A characteristic bandwidth is a band of given width to carry same amount of information, regardless of where the band is located in the frequency spectrum. According to Hartleys Law, channel capacity or the digital data transfer rate of a physical communication link is proportional to bandwidth. Bandwidth is proportional to $1 / T$ where $T =$ bit time) Therefore, the bandwidth of the data signal is $1 / T_b$ and the bandwidth of the spread spectrum signal is $1 / T_c$. Since T_c is much smaller than T_b , the bandwidth of the spread spectrum signal is much larger than the bandwidth of the original signal. The ratio T_b / T_c is called spreading factor or processing gain and determines to a certain extent the upper limit of the total number of users supported simultaneously by a base station.^[2]

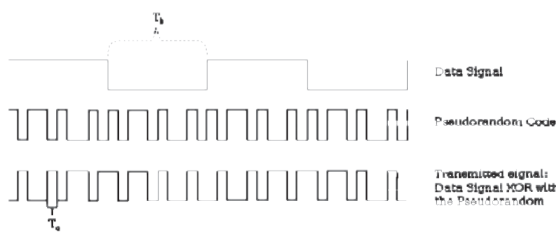

Each user in a CDMA system uses a different code to modulate their signal. Choosing the codes used to modulate the signal is very important in the performance of CDMA systems. The best performance will occur when there is good separation between the signal of a

desired user and the signals of other users. The separation of the signals is made by correlating the received signal with the locally generated code of the desired user. If the signal matches the desired user's code then the correlation function will be high and the system can extract that signal (otherwise it would discard the signal). In general, CDMA belongs to two basic categories: synchronous (orthogonal codes) and asynchronous (pseudorandom codes).

Asynchronous CDMA has some level of privacy built-in because the signal is spread using a pseudo-random code; this code makes the spread spectrum signals appear random or have noise-like properties. A receiver cannot demodulate this transmission without knowledge of the pseudo-random sequence used to encode the data.

Synchronous CDMA exploits mathematical properties of orthogonality between vectors representing the data strings (each user being assigned a unique vector chosen from a huge set of codes). For example, binary string 1011 is represented by the vector (1, 0, 1, 1). Vectors can be multiplied by taking their dot product, by summing the products of their respective components. If the dot product is zero, the two vectors are said to be *orthogonal* to each other (note: if $u = (a, b)$ and $v = (c, d)$, the dot product $u \cdot v = ac + bd$). Some properties of the dot product aid understanding of how W-CDMA works. If vectors a and b are orthogonal, then $a \cdot b = 0$ and:

$$\begin{array}{ll}
 a \cdot (a + b) = \|a\|^2 & \text{since } a \cdot a + a \cdot b = \|a\|^2 + 0 \\
 a \cdot (-a + b) = -\|a\|^2 & \text{since } -a \cdot a + a \cdot b = -\|a\|^2 + 0 \\
 b \cdot (a + b) = \|b\|^2 & \text{since } b \cdot a + b \cdot b = 0 + \|b\|^2 \\
 b \cdot (a - b) = -\|b\|^2 & \text{since } b \cdot a - b \cdot b = 0 - \|b\|^2
 \end{array}$$

Each user in synchronous CDMA uses a code orthogonal to the others' codes to modulate their signal. An example of four mutually orthogonal digital signals is shown in the figure below. Orthogonal codes have a cross-correlation equal to zero; in other words, they do not interfere with each other. In the case of IS-95 64 bit Walsh codes are used to encode the signal to separate different users. Since each of the 64 Walsh codes are orthogonal to one another, the signals are channelized into 64 orthogonal signals. The following example demonstrates how each user's signal can be encoded and decoded.

Example

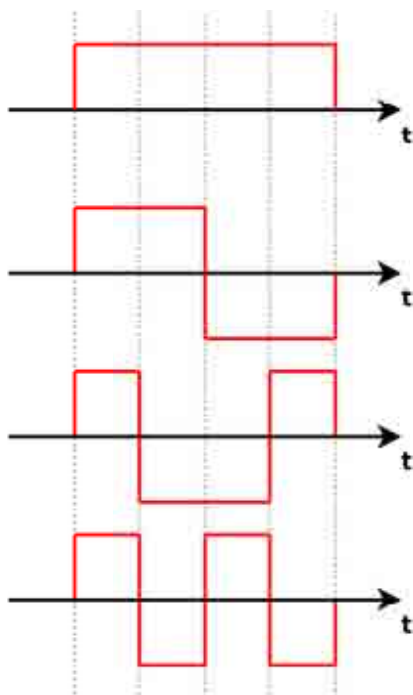

An example of four mutually orthogonal digital signals.

Start with a set of vectors that are mutually orthogonal. (Although mutual orthogonality is the only condition, these vectors are usually

constructed for ease of decoding, for example columns or rows from Walsh matrices.) An example of orthogonal functions is shown in the picture above. **These vectors will be assigned to individual users and are called the *code, chip code, or chipping code*.**

There are trillions of possible frequency-sequencing codes; this enhances privacy and makes cloning difficult. The technology is used in ultra-high-frequency (UHF) cellular telephone systems in the 800-MHz and 1.9-GHz bands.

Now, due to physical properties of interference, if two signals at a point are in phase, they add to give twice the amplitude of each signal, but if they are out of phase, they subtract and give a signal that is the difference of the amplitudes. Digitally, this behaviour can be modeled by the addition of the transmission vectors, component by component.

It is to be noted that CDMA is a channel access method used by various radio communication technologies. It should not be confused with Mobile Phone standard called CDMA One and CDMA 2000 (which are also often referred to as simply CDMA) which use CDMA as an underlying channel access method.

9.4.4.1 Mobile Communication

Cellular mobile communication has provided the novelty of communicating from anywhere, anytime, anyplace and has revolutionized the telecommunication service in India, providing an on-demand telephone at affordable cost. Cellular mobile usage has become very popular among the masses (surpassing the number of conventional fixed

telephones) and has a share of 95.66% of the total telephone lines of 806.13 million (mobile + fixed) in the country as on 31st January, 2011.

BTS (Base Transceiver Station) or Mobile tower picks up the information (Signals) from the mobile handset and then process them for transport across the network.

Basically, there are two standards, namely, GSM (Global System for Mobile) and CDMA (Code Division Multiple Access) for operating the mobile system. Evolution of mobile communication is shown in **Appendix-VII**. In India GSM operates in 900 and 1800 Mhz band and CDMA operates in 800 Mhz band. Mobile systems are evolving over the years and the evolution is denoted by their Generation (1G,2G,3G) which indicates the enhanced services in offering such as multimedia support etc. Presently the Mobile System in India belong to 2.5G Category and evolving towards 3G technology in 2.1 Ghz band which promises higher bit rate of 2 Mbps. A brief note on national spectrum allocation is furnished in **Appendix – VI**. The 2G and 2.5G radio mobile systems are already in the network. 3G and 4G mobile systems are expected to provide broadband, interactive, multi-media services in the very near future.

9.4.4.2 Global System for Mobile (GSM) is a cellular standard developed to cater voice services and data delivery using digital modulation. In addition to providing a range of supplementary services, GSM differentiates itself from previous and competing technologies in two key ways. First, it enables a user to roam between networks—a user can use the services of their home network in another, interconnected

network. These services include both the original voice-based service and the supplementary and text-based services. Second, it offers in-built security—authentication and encryption. GSM devices use a smartcard, known as a Subscriber Identity Module (SIM), that contains operator and subscriber specific data that enable users to be authenticated and sessions (voice or data) to be encrypted over the air.

Mobile Network Architecture

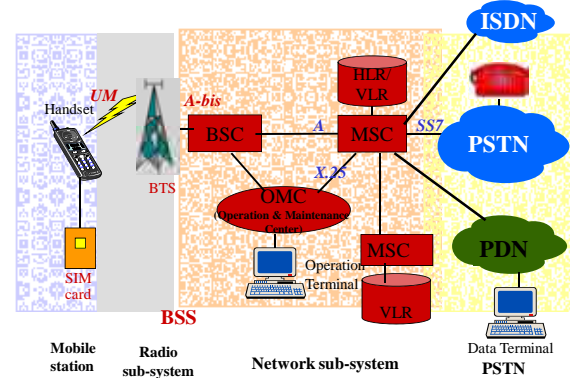

In a cellular system, the geographical area is divided into adjacent, non-overlapping, hexagonal shaped cells. Each cell has its own Transmitter and Receiver (called Base Stations) to communicate with the Mobile units in that cell; whenever a mobile unit crosses cell boundaries, a Mobile Switching Centre in the network coordinates the handoff of mobile units to maintain the communication. The system hands over calls from transmitter to transmitter, as customers move around in their vehicles.

Cellular systems are based on the concept of frequency reuse, i.e. the same frequency is used by several sites, which are physically separated far enough from one another, thus conserving the frequency spectrum. One of the most important concepts for any cellular

telephone system is that of multiple access, meaning that multiple, simultaneous users can be supported through frequency reuse. In other words, a large number of users share a common pool of radio channels (spectrum) and any user can gain access to any channel (each user is not always assigned to the same channel), which is temporarily allocated for the communication.

A schematic overview of the GSM system is shown in the figure given above. The system is composed of three main components: Mobile Switching Subsystem, Base Station Subsystem, and the Mobile handset. Base station part controls the communication across the air (radio) interface. The Switching Subsystem enables the connection between the two mobile users. The Mobile handsets act as the transmitter/ receiver for the user for communicating with others. The functions of various components in GSM mobile network are described in brief in the following paragraphs.

Base Station Subsystem (BSS)

Base Station Subsystem provides the direct contact with the mobile handset through air interface and links it to the Switching centre. **Base Transceiver Station (BTS)** and **Base Station Controller (BSC)** together, form a functional entity of the Base Station Subsystem

Base Transceiver Station (BTS)

BTS provides the mobile's interface to the network. Each cell site is equipped with a BTS, which is usually located in the center of a cell to provide coverage within a cell, which may cover an area of 30 - 40 sq kms. However, in a congested, urban location, the BTS coverage area is much smaller. The transmitting power

of the BTS and number of customers in the cell determine the absolute cell size. BTS houses the radio transceivers that define a cell and handles the radio-link protocols with the Mobile handsets.

Base Station Controller (BSC)

It monitors and controls several BTS. It is linked to the several BTSs on one side and with the Mobile Switching Centre (MSC) on the other side. The chief tasks of the BSC are frequency administration and the control of BTS; and also, is in charge of all radio interface management through the remote command of the BTS and the mobile station, mainly the allocation and release of radio channels and the handover management. The hardware of the BSC may be located at the same site as the BTS, at its own standalone site, or at the site of the Mobile Switching Centre (MSC)

Mobile Switching Centre (MSC)

MSC performs the telephone switching functions of the system. It acts like a normal switching node of the PSTN, but additionally provides all the functions needed to handle a mobile subscriber, such as registration, authentication, location updating, handovers, and call routing to a roaming subscriber. MSC is the primary switching interface between the mobile telephone systems and other networks such as PSTN, PDN etc. as well as with the mobile networks of other service providers.

It is capable of routing calls from the fixed network and other service provider's mobile network - via the BSC and the BTS - to an individual mobile station. MSC also provides the network with specific data about individual

mobile stations. The MSC interfaces with BSS on one side (through which it is in contact with GSM users) and with the external networks on the other.

Home Location Register (HLR)

HLR is a database about subscribers; it stores the identity and user data of all the subscribers belonging to the area of related MSC. These are permanent data, such as the International Mobile Subscriber Identity (IMSI) of an individual user, authentication key, including a subscriber's service profile, location information, activity status and some temporary data.

Temporary data on the SIM include such entries as (i) the address of the current visitor location register (VLR), which currently administers the mobile stations, (ii) the number to which the calls must be forwarded (if the subscriber selects call forwarding), and (3) some transient parameters for authentication and ciphering.

Visitor Location Register (VLR)

The VLR contains the relevant data of all mobiles currently located in a serving MSC.

It is the database that contains temporary storing subscription data for those subscribers currently situated in the service area of the corresponding MSC as well as holding data on their location at a more precise level than the HLR. The VLR is always integrated with MSC.

The permanent data are the same as data found in the HLR; the temporary data differ slightly. For example, the VLR contains the Temporary Mobile Subscriber Identity (TMSI), which is used for limited periods to prevent the transmission of the IMSI via the air - interface.

9.4.4.3 Code-Division Multiple Access (CDMA) System

CDMA is a digital cellular technology that uses spread-spectrum techniques. Unlike competing systems, such as GSM, that use TDMA.

CDMA does not assign a specific frequency to each user. Instead, every channel uses the full available spectrum. Individual conversations are encoded with a pseudo-random digital sequence.

CDMA consistently provides better capacity for voice and data communications than other commercial mobile technologies, allowing more subscribers to connect at any given time. It operates in 800 Mhz band

The following diagram shows the network diagram for the CDMA technology:

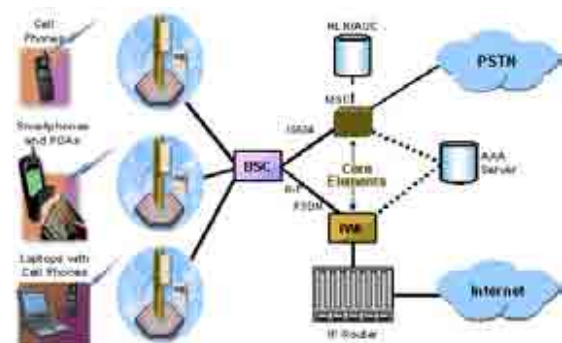

9.4.4.4 Comparison of the GSM and CDMA Technologies used for Cellular Services

For providing cellular service, the Mobile Industry in India, following the trend world over, is divided between two competing network technologies viz:

GSM (Global System for Mobile Communications) and CDMA (Code Division

Multiple Access). While the early service providers had adopted the GSM technology, the new players have been using CDMA technology that has picked up a significant share of Indian market for communication.

GSM technology is a form of multiplexing that uses combination of Time and Frequency-Division Multiple Access (TDMA/FDMA). The FDMA part involves the division of frequency bandwidth of the 25 MHz (being normally the maximum) into 124 carrier frequencies spaced 200 kHz apart. Each of these carrier frequencies is then divided in time, using a TDMA scheme. The fundamental unit of time in this TDMA scheme is called a burst period and it lasts 15/26 ms (or approx. 0.577 ms). Eight burst periods are grouped into a TDMA frame (or $8 \times 15/26 = 120/26$ ms, or approx. 4.615 ms), which forms the basic unit for the definition of logical channels. One physical channel being one burst period per TDMA frame, GSM allows eight simultaneous calls on the same radio frequency.

GSM standard was developed by the European Telecommunication Standard Institute (ETSI) in 1990 using 900 MHz spectrum band (for circuit switched network to replace 1st generation analog cellular network) for full duplex voice technology and it was expanded for packet switched data transport via GPRS (General Packet Radio Service) in 2000 to provide internet service etc and speed of packet data transport was later on increased further via EDGE (Enhanced Data rates for GSM Evolution) in 2003 GSM standard was succeeded by 3rd generation (3G) UMTS standard by GPP. It is expected to evolve further with induction of 4th generation (4G) LTE Advanced standards.

CDMA standard was developed by Qualcomm Inc, USA and it became an international standard in 1995 (through CDMA was first used during world war-II by the English allies to foil German attempts at jamming transmissions, because it was difficult for the German to pick up to complete signal, being transmitted in Several frequencies, instead of a single frequency).

The technologies are normally evaluated on the following three parameters namely the data transmission capacity, security and radiation levels.

Following table indicates the data transmission of different technologies.:

Cellular technology	Generation	Data transmission capacity
GSM	2G	56 Kps
CDMA (IS-95B)	2.5G	64 Kps - 140 Kps
CDMA 2000	3G	2 MBps

Though GSM(TDMA) will not accommodate more than a finite number of users (the user will get the Network Busy message if this number is exceeded), there won't be any deterioration in voice quality due to traffic. In addition, GSM network is also equipped with Frequency-Hopping, i.e., when a lower frequency is cluttered, the mobile phone effortlessly jumps to a higher frequency (e.g., from 900 MHz to 1800MHz). GSM technology also employs the EFR (Enhanced Frequency Rate) add-on, which improves the voice quality greatly. CDMA technology has a Soft Accommodation feature, i.e., when the number of users of the network goes up, the voice quality progressively gets poorer.

CDMA technology facilitates a Soft Handoff, i.e., when a mobile phone has to choose between two cells, and then shift from one of them to another as the user travels, the transition is very smooth. In GSM, however, the handoff is a Hard Handoff, i.e., the phone first stops receiving and transmitting on the old channel, and then commences transmitting and receiving on the new channel.

Ideally, the GSM technology's talk-range from a tower is 35 kms in comparison with CDMA's 110 kms, and the power output of a GSM phone is 2W, in comparison with CDMA phone's 200 mW i.e., CDMA implies lesser radiation hazard. But the talk time is generally higher in a GSM phone due to its pulse nature of transmission, in comparison with a CDMA phone which transmits all the time.

The most obvious distinction between GSM and CDMA is the SIM (subscriber identity module) card, the onboard memory device in a GSM phone that identifies a user and stores their information. One can swap GSM SIM cards between phones which enables one to move all of the contact and calendar information over to a new handset with no hassle. The ability to upgrade or change to another handset is difficult with CDMA technology, because the network service information of user is put in the actual handset (unlike SIM card facility for GSM) being used.

When it comes for international roaming, handsets with GSM is far better than CDMA handsets because GSM is used in most of the markets across the globe. Users using tri-band and quad-band can travel to Europe, India and most of Asia and still can use their cell phone. CDMA does not have this multiband capability, thus cannot be used in multiple countries with ease.

Since bandwidth is the major problem in the modern times the CDMA has a very clear advantage over the GSM in this context. The number of channels(users) that can be allocated in a given bandwidth is comparatively higher for CDMA than for GSM. The cost of setting up a CDMA network is also comparatively less than the GSM network. Due to these advantages there is high probability that CDMA technology will dominate the future of mobile communications.

As far as radiation level concerned, CDMA is the most harmless one among all existing technologies. Of course, it transmits microwaves while on standby mode, like other technologies do. However, CDMA technology checks 800 times per second its transmission level. Therefore, radiation level is 10 times less than GSM. Another important thing to point out is that CDMA system transmits signals only when the user starts conversation. Simply saying, when the user is listening the other ends conversation, the user is not affected by microwave as the speaking person does.

9.4.4.5 Future Trends

The technologies of cellular mobile network are evolving to provide progressively higher data rates and improved spectral efficiency with 3G and 4G systems. Ultimately, it will enable to achieve diversification in the deployment scenarios for each technology so that they operate in an intergraded network to optimise network resources. Under 4G standards, LTE (Long Term Evolution) systems have been planned, which envisage to achieve the above objective of integrating all the mobile technologies.

LTE system use extensively MIMO (Multiple Input Multiple Output) and higher order PSK(Phase Shift Keying) as transmission technologies to increase data rates of the air interface and introduce all IP network capability. LTE system provide superior technology features such as efficient power management, advanced authentication and encryption, advanced error correction techniques, QoS (Quality of Service) supporting different traffic types etc. LTE creates an end-to-end IP-based network which offers higher data rates of 34 Mbps and above. The evolutionary path is shown in **Appendix –VII**. The economics and demand will decide the extent of proliferation of these technologies

9.4.5 Wi-Fi Technology

Wi-Fi stands for Wireless Fidelity and it is a way to get Internet access using microwave wireless medium. Wi-Fi is used to define any of the wireless technology in the IEEE 802.11 specification - including (but not necessarily limited to) the wireless protocols 802.11a, 802.11b, and 802.11g. The Wi-Fi Alliance is the body responsible for promoting the term Wi-Fi and its association with various wireless technology standards.

A Wi-Fi hotspot is defined as any location in which an 802.11 (wireless) technology exists and is available for use to consumers.

In some cases, the wireless access is free, and in others, wireless carriers charge for Wi-Fi usage. Generally, the most common usage of Wi-Fi technology is for laptop users to gain Internet access in locations such as airports, coffee shops, and so on, where Wi-Fi technology can be used to help consumers in their pursuit of work-based or recreational Internet usage.

Wi-Fi has many advantages. Wi-Fi networks are easy to set up and inexpensive. One wireless router can allow multiple devices to connect to the Internet.

Due to sustained development in technology, Wi-Fi networking standards, framed by IEEE, have also evolved enabling to achieve higher data throughputs. These standards are:

- **802.11a** transmits at 5 Ghz radio signal up to 54 megabits of data per second. It uses **orthogonal frequency-division multiplexing** (OFDM), a more efficient coding technique that splits the radio signal into several sub-signals, before they reach a receiver. This greatly reduces interference problem.
- **802.11b** is the slowest and least expensive standard. For a while, its low cost made it popular, but now it's becoming less common as faster standards become less expensive. 802.11b transmits in the 2.4 Ghz frequency band of the radio spectrum. It can handle up to 11 megabits of data per second, and it uses **complementary code keying** (CCK) modulation to improve speed.
- **802.11g** transmits at 2.4 Ghz like 802.11b, but it's a lot faster. It can handle up to 54 megabits of data per second. 802.11g is faster because it uses the same OFDM coding as 802.11a.
- **802.11n** is the newest standard that has been conceived with the goal of increasing wireless local area and providing higher data rate. This standard significantly improves

speed and range of 802.11g. Although 802.11g theoretically moves 54 megabits of data per second, it only achieves real-world speeds of about 24 megabits of data per second because of network congestion. 802.11n, however, reportedly can achieve speeds as high as 140 megabits per second.

9.4.6 WiMAX (Worldwide Interoperability of Microwave Access) Technology

WiMAX works very much like cell phone technology because a reasonable proximity to a base station is required to establish a data link. Users within 10 kms of the base station will be able to establish a link using non-line-of-sight (NLOS) technology with data rates as high as 75 Mbps.

However, users up to 50 kms away from the base station need an antenna, mounted for line-of-sight (LOS) to the base station, to provide data rates approaching 280 Mbps.

WiMAX is a wireless access service designed to cover wide geographical areas serving large numbers of users at low cost providing IP connectivity. WiMAX is the synonym given to the IEEE 802.16 standard defining wide area wireless data networking, a standard, which is being adopted worldwide by manufacturers to insure inter-operability of equipment. WiMAX is considered one of the best solutions for “last mile” distribution. In contrast, wireless local area networks (WiLANs) are designed to provide network access within an office environment or a home. WiMAX can be used to connect WiLANs.

WiMAX uses microwave radio technology to connect computers to the (IP) data network

in place of wired connections such as DSL or cable modems. Although, primarily a wireless broadband data network, the advent of VoIP and native quality of service capabilities enable WiMax to offer quality voice services at relatively low cost (being an all-IP network).

WiMAX 802.16e is a mobile version of the Institute of Electrical and Electronics Engineers (IEEE) 802.16 standard. It supports time division duplex (TDD) frequencies in 2.3 Ghz to 2.5 Ghz and 3.3 Ghz to 3.5 Ghz. WiMAX 802.16e has been deployed to support mobile, metro area and broadband wireless capabilities.

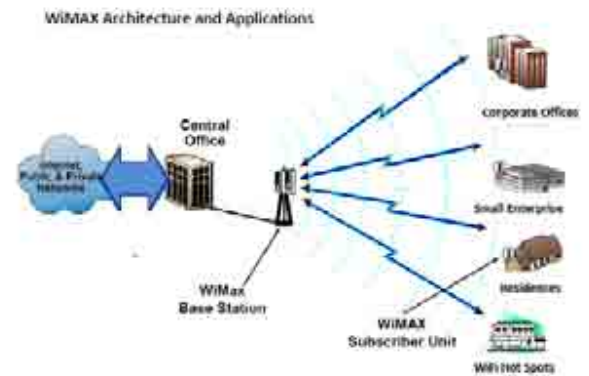

9.4.7 Public Mobile Radio Trunking System (PMRTS)

Public Mobile Radio (PMR) is a two-way radio, employing one-to-many, point-to-multipoint type of calling system. Two-way radio operates in frequencies ranging from 66-88 Mhz, 136-174 Mhz, 403-520 Mhz and 800 Mhz frequency. This results in faster communication of urgent messages or vital information within any organization. Conventional VHF system is the foundation of two way radios. In conventional two-way radio communications, users have a dedicated frequency channel for their own use. However, a shortcoming of the two-way radio communications is that there can only be

one person speaking at a given point of time and as the numbers of users grow, frequency congestion occurs since there are only a finite number of frequencies. This short coming is overcome by another variant of two-way radio communication known as radio trunking, (viz Public Mobile Radio Trunking system(PMRTS)) in which a set of frequencies are used for enabling simultaneous multiparty communication within the group.

When radio channels are trunked, it means that radios automatically get a free 'path', at the press of a button, to communicate with each other. The handsets can be installed in vehicles or small enough to be carried around in hand. In radio trunking, a large number of users share a relatively small number of communication paths –or trunks.

Features of Radio Trunking

Radio trunking allows making not just two-way voice calls but also allows selective base to mobile group calls and mobile to mobile selective calling. Then one can also have mobile to PABX interconnect and mobile to telephone interconnect depending on the policy conditions of the country. Additionally, data services like short and long data messages can also be made available on radio trunking services. Other add-on features come in the form of electronic display panel showing status, caller identity, received call acknowledgement, automatic queuing among others.

From policy perspective, the end-user (which means any organization) is required to take an operating license from the wireless planning commission (WPC) for use of a certain dedicated frequency. This method of two-way

radio provision is also known as the captive service option, as this allows an organization to operate directly with the user license without having to go to any service provider. Captive systems are best used by organisations like police, security forces, etc., which cannot use public networks due to security reasons.

Standards in Radio Trunking

Like the other telecommunications system, radio trunking also operates on many parallel standards. Terrestrial trunked radio or Tetra is a standard of European origin, defined by the ETSI. Tetra is an open-standard for next generation digital mobile communications. The standards enable voice delivery, data and messaging services for one-to-one and one-to-many communications.

Association of Public safety Communications Officers (APCO) is another standard of the US origin. An open and digital standard, APCO also delivers voice delivery, data and messaging services for one-to-one and one-to-many salutation. Integrated Dispatch Enhanced Network (iDEN) is another two-way radio proprietary technology and it enables digital telephone, two-way radio. Short message service and wireless modem service.

The British ministry of post and telecommunications (MPT) defines another open standard, which uses a digital control channel with analog voice channels. Several PMR technologies available are TETRA iDEN, TETRAPOL, ASTRO, EDACS using TDMA/FDMA. TETRA is an open standard while others are proprietary. Only Tetra Offers DMO (Direct Mode of Operation-handset to handset), whereas others do not support this feature.

Indian Scenario

In India, the main users consist of government departments, securities, defence establishments, hotels, municipal corporations, schools, cash vans, radio-taxis, courier and other fleet management systems. Of the existing technologies, TETRA, is the most popular technology in India, which offers open standard and Direct Mode of Operation. Details of TETRA system are furnished in **Appendix VIII**.

9.4.8 VHF Radios

Very high frequency (VHF) is the radio frequency range from 30 Mhz to 300 Mhz. Frequencies immediately below VHF are denoted High frequency (HF), and the next higher frequencies are known as Ultra high frequency (UHF). VHF propagation characteristics are ideal for short-distance terrestrial communication, with a range somewhat farther than line-of-sight from the transmitter. Unlike high frequencies (HF), the ionosphere does not usually reflect VHF radio and thus transmissions are restricted to the local area (and do not interfere with transmissions thousands of kilometers away).

With the rapid technological advancements taking place, other network technologies such as GSM network have several advantages like seamless integration into the existing network and vast coverage.

However, VHF based communication technologies have been widely used for Disaster communications due to their simplicity of operation and fast deployment and particularly where the towers for mobile network do not exist or disrupted.

9.4.9 Portable AM/FM Broadcasting Radio Station

Radio broadcasting is an efficient method for disseminating information at the disaster site.

Thanks to rapid advancement in technology, completely portable radio station in a box is now commercially available, which can be set-up at the disaster site within few hours. Tailor-made programs as per the requirement of disaster site can be transmitted to the community over a large area.

The packaged portable radio station typically contains three portable packs namely broadcast studio, transmitter rack and antenna system. The broadcast studio provides features such as audio mixer, CD players, audio recorder, cassette player, monitoring headsets, which are essential for creating the information content.

Two types of technologies exist viz: FM (Frequency Modulation) broadcast and AM (Amplitude Modulation) broadcast. AM radio operates in the frequency range 535 to 1705 KHz whereas FM radio coverage is the frequency range of 88 to 108 MHz. In AM transmission, coverage distance depends on various factors like soil conductivity, time of day (day/night) and RF propagation condition as the transmission depends on the ionospheric layer (which shifts between day and night). Thus, portable AM equipment range for quality reception is typically around 15 km radius. FM radio broadcast on the other hand depends on line-of-sight transmission and can easily cover a radius of 25km. The power output of a typical transmitter is 500 watts.

In order to receive the broadcast messages, AM/FM receiver/tuner sets have also to be supplied to various officials, NGOs, Civil Defense and Home Guard personnel. AM/FM receivers are available with the provision to work on battery, AC adapter or solar power. The receiver sets can also be powered using hand cranks, which comes along with receiver set. Charging cell phones facility is also available. In the event of mobiles phones functioning in the area, FM transmission can also be received by the communities, who have mobile phones with FM capability.

9.5 Emerging Scenario

DM dynamics clearly dictate that there is no option but to keep in touch with the emerging technologies. Advances in microelectronics, computers, sensors and communication networks the world over appear often faster than those people directly involved who can track it.

Technologies, especially informatic, communications and computer technology know no boundaries with their diffusion worldwide. The emerging Communication and Informatic revolution is a consequential product of phenomenal advancements in computerized information and communication technologies. The buzzword is "Informatic Explosion" where the world has already started to shift from an industrial to an information based society. This technological revolution is phenomenal and harnessing this revolution is essential to meet our national DM needs. The emerging technologies are in fact digitizing the communication and informatic space in a converged and

seamless manner. In effect, therefore, a very wide and complex array of emerging technological possibilities are available at our disposal for modernizing and upgrading our DM communications and information networks (keeping in mind the budgetary constraints). A few of the key emerging technological trends in brief are explained in this chapter.

9.5.1 Orthogonal Frequency Division Multiplex (OFDM)

Orthogonal Frequency Division Multiplex (OFDM) is a modulation format that is finding increasing levels of use in today's radio communications scene. OFDM is a different format for modulation to that used traditionally. It utilizes many carriers together to provide advantages over simpler modulation formats.

An OFDM signal consists of a number of closely spaced modulated carriers.

When modulation of any signal form (voice, data, etc) is applied to a carrier, sidebands spread out either side, which can pose problems for a receiver in demodulation. As a result, when closely spaced modulated carriers are transmitted, they must be spaced with a guard band so that the receiver can separate them using a filter.

When OFDM is employed, there is no need to provide guard band. Although the sidebands from each carrier overlap, they can still be received without the interference that might be expected because of the inherent orthogonal character of the sidebands in OFDM. This is achieved by having the carrier spacing equal to the reciprocal of the symbol period.

However, data to be transmitted on an OFDM signal is spread across the carriers of the signal, each carrier taking part of the payload. This reduces the data rate taken by each carrier. The lower data rate has the advantage that interference from reflections is much less critical. This is achieved by adding a guard time interval into the system. This ensures that the data is only sampled when the signal is stable and no new delayed signals arrive that would alter the timing and phase of the signal.

The distribution of the data across a large number of carriers in the OFDM signal has some further advantages: nulls caused by multi-path effects or interference on a given frequency only affect a small number of the carriers, the remaining ones being received correctly. By using error-coding techniques, which does mean adding further data to the transmitted signal, it enables many or all of the corrupted data to be reconstructed within the receiver.

OFDM is being proposed as the modulation technique for fourth generation cell phone systems that are in their early stages of development and OFDM is also being used for many of the proposed mobile phone video systems.

OFDM has been adopted in the Wi-Fi arena where the 802.11a standard uses it to provide data rates up to 54Mbps in the 5 Ghz ISM (Industrial, Scientific and Medical) band in addition to this the recently ratified 802.11g standard has it in the 2.4 Ghz ISM band. Also OFDM is being used for WiMAX and is also the format of choice for the next generation cellular radio communications systems including 3G LTE and UMB.

9.5.2 IP Multimedia Subsystem (IMS)

IP Multimedia Subsystem (IMS) is a generic architecture for offering multimedia and voice over IP services, defined by 3rd Generation Partnership Project (3GPP).

IMS is access independent, as it supports multiple access technologies including GSM, WCDMA, CDMA2000, WLAN, Wireline broadband and other packet data applications. IMS will make Internet technologies, such as web browsing, e-mail, instant messaging and video conferencing available to everyone from any location.

It is also intended to allow operators to introduce new services, such as web browsing, WAP and MMS, at the top level of their packet-switched networks.

IP Multimedia Subsystem is standardized reference architecture. IMS consists of session control, connection control and an applications services framework along with subscriber and services data. It enables new converged voice and data services, while allowing for the interoperability of these converged services between internet and cellular subscribers. IMS uses open standard IP protocols, defined by the IETF. So users will be able to execute all their services when roaming as well as from their home networks. So, a multimedia session between two IMS users, between an IMS user and a user on the Internet, and between two users on the Internet is established using exactly the same protocol. Moreover, the interfaces for service developers are also based on IP protocols.

9.5.3 RF Identification Systems (RFID)

Another technology that will help disaster management in a big way is RF identification systems, simply called RFID.

They are small, low-cost tags that can be attached to objects or persons to identify and track their position. RFID provides both proximity and dynamic identification, so that tagged objects do not need to be physically contacted or stationary in order to be identified. RFID creates an automatic way to collect information about a product, place, time or transaction quickly, easily and without human error.

It provides a contactless data link, without the need for line of sight or concerns about harsh or dirty environments that restrict other auto ID technologies such as bar codes. In addition, RFID is more than just an ID code; it can be used as a data carrier, with information being written to and updated on the tag on the fly.

RFID systems consist of a number of components including tags, handheld or stationary readers, data input units and system software. The tags are the backbone of the technology and come in all shapes, sizes and read ranges including thin and flexible "smart labels", which can be laminated between paper or plastic. RF tags are either active or passive. Active tags are usually more expensive because they can transmit a low-powered signal. These tags come with batteries and permit farther distances for RF identification. Passive tags do not come with batteries and are detected solely by the RF receiver. It will be possible to create a network to cover a large area with RF that will support reading of RF tag and reporting to control station about the movement of

consignments mounted on moving vehicles. This will result in timely assessment of material movement and planning during disaster relief.

9.5.4 Telepresence

High Definition Audio and Video are the key features of Telepresence that are used for a new generation of high 'Video Conferencing System' which facilitates virtual meeting that gives the feeling of "Almost like being there". With life like crystal clear imagery, high fidelity sound and high reliability, Telepresence takes video communications to a new level of virtual reality with associated economies as regards time saving and related economic benefits. The emerging trend is proliferation of Telepresence for individuals like senior executives, top-end managers and also for training and awareness.

9.5.5 Advanced Technology for Detection and Tracking of Trapped People

Application of ultra-wideband pseudo-random-code technique (with bandwidth of 8Ghz or more) as a hand held sensor promises innovative technology for detection of trapped people. In this application, the technology employed is radar imaging and digital signal processing.

Electromagnetic waves in the lower Ghz range can penetrate most building materials, which allows for detection of hidden targets. The principle of operation is based on the discrimination between an inanimate object and a living human being can be made by the detection and decoding of reflection of electromagnetic waves (in terms of periodicity and frequency spectrum) transmitted from the trapped human being. By tracking the signal processing to the periodicity of the breathing, the trapped human being can be localized.

This technology is likely to have major advantages in two ways. Firstly, to ascertain if the people are trapped in a room or building, without the need of entering the space (which may have been affected due to some calamity such as fire, smoke etc). Secondly, to detect people trapped beneath rubble as a result of an earthquake or explosion etc. Also, it would enable rescue team to identify the places where people trapped are still alive.

9.5.6 Multiple Input Multiple Output (MIMO) Wireless Technology

It is wireless or radio communications technology that is normally used with OFDM for many wireless and radio communications. Wi-Fi, LTE and many other radio, wireless and RF technologies are using the new MIMO wireless technology to provide increased link capacity and spectral efficiency combined with improved link reliability using what were previously seen as interference paths. MIMO is effectively a radio antenna technology. It uses multiple antennas at the transmitter and receiver end to enable a variety of signal paths to carry the data, choosing separate paths for each antenna to enable multiple signal paths to be used.

It is found that between a transmitter and a receiver, the signal can take many paths. Additionally, by moving the antennas to even the small distance, the paths used will change. The variety of paths available occurs as a result of number of objects that appear to the side or even in the direct path between the transmitter and receiver. Previously these multiple paths only served to introduce interference. By using MIMO, these additional paths are used to increase the capacity of a link.

9.5.7 Terminal Devices

Terminal devices will cater for faster processing with **Multiple Input Multiple Output (MIMO)** capability to support higher bandwidth needs of the user. As far as possible, most of the user requirements in terms of application handling will be at the **terminal device itself** and it would not depend on the switch or the media. **Computer and Telephony Integration (CTI) technology** will be the key to provide all kinds of facilities to the user at the terminal. IP telephones and IP devices will provide ideal support for uniform network approach being followed the world over. A very large array of terminal devices for desktop as also, mobile functions with requisite storage, signaling and multi-media capabilities, are available.

9.5.8 Software Defined Radio (SDR) and Cognitive Radio (CR) for Spectrum Sharing (SpS) and Flexible Spectrum Usage (FSU)

9.5.8.1 Spectrum Sharing and Flexible Spectrum Usage

Number of mobile subscribers expected to grow world over requiring new multimedia services with a very high bit rate in the order of 1 Gbps (that needs bandwidth of 100Mhz at spectral efficiency of 10bps/Hz) for low mobility i.e. for local area deployment and 100 Mbps for high mobility i.e. for wide area deployment. Regulators will hardly be able to allocate more than 1 or 2 such large bandwidth and hence a flexible and smart spectrum usages among different operators and network will be needed. A key component enabling this peaceful cooperation among systems and networks within the same bandwidth is spectrum sharing.

This is a very different situation from today's systems of wireless networks that are characterized by fixed spectrum assignment where each operator operates on a dedicated spectrum, independently without any radio resource coordination.

The need for flexible communications was experienced inter alia, in the Netherlands in 2000 when a fireworks factory exploded killing 23 people, destroying much of the town and injuring more than a thousand people. While dealing with this catastrophe, the emergency services (fire, medical, police, etc) experienced real communications difficulties because they all had different communications systems and were unable to communicate with the other services. Another major emergency was the 9-11 terrorist attacks in the USA where also communications difficulties were experienced.

While often a variety of radios would be needed for intercommunications, this would not be viable for small groups of people. Reconfigurable radios would enable far more effective communications to be achieved.

In Spectrum sharing, independent operators/users use the same spectrum within the same bandwidth and in Flexible Spectrum Usage, devices are able to use spectrum in a flexible manner by adapting their operation to the current situation e.g. by sensing the environment or based on pre-defined regulatory policies. In such a situation, the spectrum would be allocated in a dynamic manner to the different operators based on average traffic demand and the agreed policies and it would play a major role leading to improved efficiency as well as fairness among operators.

9.5.8.2. Software Defined Radio (SDR)

A Software Defined Radio (SDR) is a transmitter in which operating parameters, including transmission frequency, modulation type, and maximum radiated or conducted output power can be altered without making any hardware changes. SDR is a technology that enables "reconfigurable system" for wireless networks.

Unlike a traditional radio (where radio components are implemented in analogue components or silicon), SDR uses reconfigurable processors instead. Thus, SDR is a radio communication system which can reconfigure i.e. tune to any frequency band and receive any modulation across a large frequency spectrum by means of programmable hardware (that is controlled by software). The goal is to produce a radio that can receive and transmit, whenever there is a change in the radio protocol, simply by running new software.

In the long run, antenna will remain the only band-specific item and SDR is expected to become the dominant technology in radio communications which is also likely to be the enabler of Cognitive Radio.

SDR would extend many advantages over traditional radios under different circumstances viz (i) enable personal wireless devices to support GSM, GPRS, Wi-Fi, WiMax, Blue Tooth etc. (ii) enable military radios to support about 20 different military radio standards using a single device, and (iii) create SDR-based gateway between incompatible radio systems to set up adhoc temporary telecom infrastructure under disaster recovery scenarios.

9.5.8.3. Cognitive Radio

Studies have shown that spectral utilization is relatively low when examined not just by frequency domain, but also across the spatial and temporal domains. Thus, an intelligent device, aware of its surroundings and able to adapt to the existing RF environment in consideration of all three domains, may be able to utilize spectrum more efficiently by dynamically sharing spectral resources.

While evolutionary technological developments are required to improve spectral efficiency by increasing the number of users in each frequency band, revolutionary technological advancements are to be introduced in terms of cognitive radios, which promise more efficient spectrum utilization through environmental awareness. This technology builds on the accomplishments of Software Defined Radio, which replaces the classical heterodyne radio (with a digital signal processor).

Cognitive radio is the “intelligence” that sets above the SDR and lets a SDR determine which mode of operation and parameters to use. By using advanced computing power to sense the existing radio frequency (RF) environment, cognitive radios become aware of and can respond to that environment through adaptation to statistical variations in the input stimuli, with two objectives in mind viz highly reliable communication whenever and wherever needed and efficient utilization of radio spectrum further.

The radio will need to determine the occupancy of the available spectrum, and then decide the best power level, mode of transmission and other necessary characteristics.

Additionally, the radio will need to be able to judge the level of interference it may cause to other users. In some instances, knowledge of geography and this may alter what it may be allowed to do. Main functions of CR would therefore, be spectrum sensing (i.e. detecting unused spectrum), spectrum management (i.e. capturing the best available spectrum), spectrum mobility (i.e. maintaining seamless communication during the spectrum transition) and spectrum sharing (providing fair spectrum scheduling method)

To achieve the required level of performance will need a very flexible front-end. Traditional front-end technology cannot handle these requirements because they are generally band limited (both for the form of modulation used and the frequency band in which they operate). Even so called wide band receivers have limitations and generally operate by switching front ends as required. Accordingly, the required level of performance can only be achieved by converting to and from the signal as close to the antenna as possible. In this way no analogue signal processing will be needed, all the processing being handled by the digital signal processing.

The conversion to and from the digital format is handled in conventional radio by digital to analogue converters (DACs) and analogue to digital converters (ADCs). To achieve the performance required for a cognitive radio, the DACs and ADCs should not only have an enormous dynamic range, and but also be able to operate over a very wide range, (extending up to many Ghz). Further, in the case of the transmitters, they must be able to handle

significant levels of power even though these requirements are currently beyond the limits of the ADC/DAC technology available, the required DAC and ADC technology will undoubtedly become available in the future, thereby making cognitive radio a reality.

The key features of CR would centre around (i) Modulations being implemented as software, (ii) Digital signal processing algorithms and (iii) Digital frequency Synthesis (based on Digitally-generated oscillators and sinusoids generated by using lookup tables). Digital filtering (where mathematical operation to streaming data would be applied), leading to a situation where “new behaviour” would be defined by “new software”.

9.5.9 High Altitude Platform Stations (HAPS)

A HAPS is defined as a station located on an object at an altitude of 20 to 50 kms and at a specified, nominal fixed point relative to the earth. Each HAPS will offer a new means of providing International Mobile Telecommunications (IMT-2000) with minimal ground network built out.

Each HAPS will be positioned above commercial air space at an altitude that is high enough to provide service to a large footprint but that is low enough to provide dense coverage..A HAPS system consists of a HAPS, ground stations and subscriber stations. Each HAPS deploys a multi-beam antenna capable of projecting numerous spot beams within its coverage area.

The HAPS system subscriber stations are identical to those used with terrestrial IMT-2000

systems. Diagrammatic representation of HAPS is given in Figure below. The use of HAPS as a means of providing IMT-2000 type services has been the subject of extensive studies. It has been recognized that the HAPS could provide Base stations enabling optional means of transmission of IMT-2000 services.

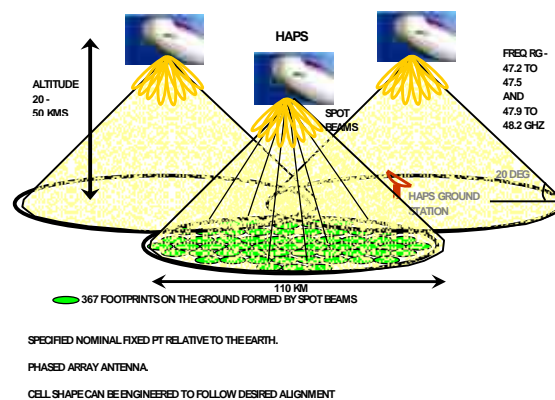

Since the HAPS airship is located at lower altitude compared with the satellite, the transmission delay and path loss in the HAPS based systems is smaller than the satellite system. Therefore, it would also bring about size reduction of communication terminals and realization of high capacity communication. A HAPS based system has flexible design possibilities such as the number of airships, service area and offered services and applications, in order to fit the area size of land and the states of the infrastructure construction in each country. Therefore, each country can define and operate service items such as offered application, communication fee and service area based on the arranged system. The footprint of HAPS system can be engineered to follow the desired boundaries, e.g. the International Boundary between two countries.

9.5.10 Unified Messaging System

Unified Messaging is the integration of several different communications media, such that users will be able to retrieve and send voice, fax and email messages from a single interface. This evolutionary vision envisages the integration and inter-operability of fixed, mobile, and mobile-satellite networks through a common terminal.

Such networks, called hybrid networks, use a common spectrum to be shared between satellite space segment and the terrestrial network, making frequency planning and network coverage much easier.

Whether it is a telephone, mobile or personal computer, it breaks down the terminal and media barriers so that the people using different technologies, different media and different terminals can still communicate to anyone, anywhere, at anytime. Use of Analog Display Services Interface (ADSI) technology to switch from voice to data during a connected session (between two subscribers or machines) is possible now. With unified messaging, the barrier between the voice mailboxes at work, the voice mailboxes at home and all email boxes will be seamlessly unified. With unified messaging systems, disaster managers at all levels can have virtual office with them in the form of a laptop, mobile or any landline telephone. Unified Messaging offers a collection of services to end-users by which, one can send, retrieve and manage e-mail, voice mail and fax mail on one terminal. In addition, messages can be managed from various terminal types including phones, web-browsers and standard

e-mail clients. Different service levels for different end-user groups can be formulated to achieve various service definitions with multiple classes. The products of Unified Messages are highly scalable and platform independent, thus, making existing resources reusable.

The maturing of International Mobile Telecommunication (IMT-2000) system and Mobile Satellite Service (MSS) using the conventional geostationary orbit and non-geostationary orbit such as the Low Earth Orbit Satellites (LEOS), Medium Earth Orbit Satellites (MEOS), and Highly Elliptical Orbit Satellites (HEOS) would enable quality networking of such sites. The developments in this area are evolving towards universal mobile telecommunication services that would include speech, data, video, and multimedia.

9.5.11 IPV6

Most of today's internet uses IPv4, which is now nearly twenty years old. There is a growing shortage of IPv4 addresses, which are needed by all new machines added to the Internet. The limited address range forces organizations to use Network Address Translation (NAT) firewalls to map multiple private addresses to a single public IP address and NATs does not support standards-based network-layer security.

The Internet Engineering Task Force (IETF) has designated IPv6 as the successor to version 4 for general use on the Internet. It significantly increases the size of the address space used to identify communication endpoints in the Internet, thereby, allowing it to continue its tremendous growth rate. IPv6 is also known as IPng (IP Next Generation).

IPv6 features a larger address space than that of IPv4. IPv6 has 128-bit (16 byte) source and destination IP addresses while IPv4 supports only has 32-bit(4byte) IP address. The large address space of IPv6 has been designed for multiple levels of subnetting and address allocation from the Internet backbone to the individual subnets within an organization.

Security was also an issue for IPv4. Although there are many ways of encrypting IPv4 traffic, such as using the IPSec protocol, but unfortunately, all of the IPv4 encryption methods are proprietary and no real standard encryption methods exist. Security is the feature available in IPv6. The IPv6 header has a new header format that is designed to minimize header overhead

The large scale use of this technology will enable unlimited availability of IP addresses, establishment of QoS standards in a network, and seamless mobility in the IP environment etc. The government of India has decided fast deployment of IPV6 compliant equipment.

9.5.12 Next Generation Network (NGN)

The present telecom networks are service dependent. Separate networks exist for voice, data, mobile, Internet, etc. Next Generation Networks (NGN) are envisaged to facilitate the convergence of voice and data networks into a single unified multi-service network capable of providing futuristic services including multi-media. In a liberalised and competitive scenario, network operators worldwide are looking for new service-independent network architectures that can facilitate introduction of new innovative services quickly in a cost effective manner. The explosion of the internet and popularity of internet multimedia services emphasized

the need to shift towards packet based core networks from the circuit-switched networks.

NGN is characterised by separation of control functions among bearer capabilities, call/session and application/service layers and promises to provide the required service creation environment using Application Programming Interface (API).

The softswitch, also known as Media Gateway Controllers (MGC), Call Servers (CS) and Call Agents are the core devices in the NGN. The Softswitch is located in the service provider's network and handles call control and signaling functions, typically maintaining call state for every call in the network. A Softswitch interacts with Application Servers to provide services that are not directly hosted on Softswitch. Softswitch carries out functions such as Call control, Signalling Gateway Control, Resource allocation, Routing, Authentication, and Charging.

Converging voice, data and video services onto a common network infrastructure will provide cost savings and performance advantages to network operators. IP/MPLS is poised to be the choice for bearer transport. ITU (International Telecommunication Union) and IETF(Internet Engineering Task Force) have jointly developed H.248/Megaco standard for separation of call control and bearer control.

Standards for call control/session control in packet-based networks are evolving. Standardisation of these protocols by ITU and IETF simultaneously has led to the emergence of several protocols such as H.323, SP, BICC-CSx, SIP-T, SIP-I. IP/MPLS networks together with Soft switches and Media Gateways are

commercially deployed in some of the countries and are likely to be deployed in India also in the near future.

The NGN architecture offers the configuration flexibility needed to support multiple access technology. This will enable adaptation to the distributed processing nature of packet-based networks and support location transparency for distributed computing. The NGN control interface is open to support service creation, service updating, and incorporation of service logic provision by third parties. The service provisioning process is separated from transport network operation by using the above-mentioned distributed, open control mechanism.

9.5.13 Multi Service Transport (MSTP)

The trend is towards establishing future networks based on the Multi Service Transport (MSTP) concept, which will support multimedia applications as well as provide global connectivity both in static and mobile mode (voice, video, data). Seamless connectivity will be an essential feature and support Virtual Specific Service Networks (VSSNs) for Closed User Groups. The network will have self-healing architecture with capability to restore in less than 50 milliseconds. Central control of the network will be maintained through Unified Network Management System for which it is necessary to have open network architecture in all the fragmented networks being introduced as on date and in future.

9.5.14 Satellite Phones

Iridium and Inmarsat have introduced satellite phones (which are similar in size to a GSM/CDMA mobile phones) with flip antenna

that are to be projected pointing upwards while talking. Primarily these phones offer voice service with limited data rates up to 2.4kbps which can be mainly used for file transfers. Iridium service is based on Low Earth Orbit (LEO) constellation of 66 satellites orbiting from pole to pole while Inmarsat employs 3 Geo-stationary satellites for worldwide coverage. Both are portable just like a cellular mobile phone and cost of a handset ranges between USD 700 to USD 1200. These satellite phones enable communication to be established from a remote site, very much similar to a mobile phone

With close scrutiny of the technological backdrop, it becomes quite evident that a very wide and complex array of emerging technological possibilities are available at our disposal for providing the right communication and IT infrastructure for the complete DM Continuum. The most important issue is understanding the employment of Multi Service Platforms (MSPs) and also micro-cellular and WiMAX solutions for the last mile connectivity. Satellite and wireless technologies are very crucial for meeting the recusants of DM Networks of any kind and dimension. Technology must be put to its proper use and must occupy its rightful place for life and material savings, besides other societal functions in the coming times.

9.6 R&D Efforts

As the requirements keep changing, based on the needs to achieve faster action in DM activities, there is a need for a continuous effort to explore various possibilities through R&D efforts. In this section, we outline some of the possible areas for R & D efforts.

- (i) **Multi Service Platforms:** Integrated Voice, Data and Video based Multi Service Platforms are an absolute necessity. These multi service platforms would be essentially required to be used by the first responders and other stakeholders to have effective inter / intra communications, since each of the stakeholders would bring in different communications / IT Networks with differing standards and protocols. Multi Input / Multi Output (MIMO) can result in immense communication and ICT possibilities for disaster management during its complete continuum.
- (ii) **Spectrum Management and Sharing:** With the development of Cognitive Radio and Software Defined Radio (SDR), this is a crucial element as far as wireless communications are concerned. The issue becomes more pronounced once the disaster strikes on a large scale, cutting across national boundaries. Such radios will facilitate connectivity and allow key stakeholders to move seamlessly between various DM groups operating on different legacy systems.
- (iii) **Lower Power Lower Cost Cellular Technology:** The world is very rapidly moving towards becoming a Mobile Information Society. It is not only technology, but also, its processes and infrastructures, which limit its implementation. Because of its omnipresence and the terminal equipment, i.e. cell phones with multi-various capabilities such as inherent PDA, low power requirement and low cost that cellular technology with requisite priority sensitive communication support needs to be fully researched and integrated into NDCN (National Disaster Communication Network) networks of today as also of the future. Also, what needs to be done is to carry out R&D pertaining to utilizing energy from the environment i.e. solar, wind, better traffic coordination, utilization of passive devices, efficient spectrum management and deployment of green house shelters
- (iv) **Dynamically Configured Adaptive Networks for Enhanced Availability:** Most of the communication problems/ disruptions occur on account of the damage to infrastructure, when a disaster takes place. What is, therefore, required is availability of redundant and resilient infrastructure with a requisite self-healing and delay tolerant network capability. Equally important is the aspect of self monitoring and repairing of networks. Such adaptive networks must be able to dynamically reconfigure and repair themselves even when infrastructure has been partially destroyed. Such networks are envisaged to be unattended systems with related applications relevant to disaster management ranging from environmental sensing to infrastructural monitoring and emergency response. In this case, another aspect is location based monitoring of available communication infrastructural capacity and adaptive / selective access to available communication networks.

- (v) **Exploitation of RFID emerging technology:** This will help in identifying the locations and personnel, remotely for rescue and relief operation.

- (vi) **Fuel Cells as Power Pack at Disaster Site**

Fuel cells, which convert hydrogen or natural gas into electricity through an electrochemical process, have long held out the promise of plentiful energy while emitting fewer pollutants than conventional power plants. While it is considered as the most efficient and eco friendly, it still faces lot of technological challenges like cost, and durability (arising from the need to use expensive precious metals like platinum and rare earth elements in some fuel cells, and corrosive materials in others) which have limited the use of fuel cells at their present technological levels. However, it is an area of future technology development, particularly, when hydrogen can be produced by splitting water through photothermal process using solar energy (water and solar energy available freely in abundance). Such fuel cells would be

especially useful for disaster areas to provide portable, standalone power plant that is reliable and operation friendly in addition to being clean and green.

9.7 Action Points

- i) Need for constant updation, both as regards, hardware infrastructure and software based applications for creation of a well defined and executed ICT based strategy for DM.
- ii) Induction of emerging ICT technologies for the Disaster Management with proper levels of investments.
- iii) Exploration for adopting the wireless technology that is constantly evolving with the development of rapidly deployable Wireless Mesh Networks based on 802.11 standards for future expansion of the last mile connectivity.
- iv) Taking up with ISRO and DoT(WPC/ Licensing) for the allotment of frequency spectrum in Ku-band (satellite) and VHF band including the permission to operate INMARSAT BGAN terminals.

10

Last Mile Connectivity

10.1 Introduction

The main responsibility for disaster management lies with the State Government and availability of last mile connectivity plays a crucial role in effective and efficient Disaster Management. Presently, the last mile connectivity exists for approximately 60% of villages through Public / Private network coverage. In a couple of years, it is expected to cover 95% of the villages in the Indian Sub-Continent. However, the existing last mile connectivity is likely to suffer damage during disaster situation.

Communication system is the first casualty in the area during disaster. Due to the natural calamity, any one or a few or the entire communication network infrastructure may have been totally affected depending on the damage caused by the calamity. In the worst scenario, the whole communication network might have broken down and the District Collector (DC) is at a loss to know what exactly is happening (about the extent of damage etc) and what exactly is required for taking relief measures, even though police communication maybe working.

Last Mile Connectivity is the most important segment of NDCN as the whole purpose of establishing NDCN is to ensure restoration of communication in the incident area in the quickest possible time.

The technologies mentioned in Chapter 9 in detail can be deployed as per the situational requirement. Each technology has its own relevance in application for the last mile connectivity for a disaster scenario. For example, satellite technology can provide failsafe system to provide last mile connectivity at the disaster site. SAT phones will provide instant reliable telephone connectivity after reaching the site, irrespective of condition of terrain. Satellite terminals can link to the National network.

Communication within the rescue teams can be established quickly with the help of VHF technology equipments. Limited mobile service is possible by deploying portable equipments using GSM/CDMA/Tetra technology, depending upon the extent of damage. Areas isolated from the telecommunication network as a result of disaster can be temporarily restored by laying light weight optical fiber cables using tree-tops/ poles or by installing transportable microwave systems. The emergency response during the disaster will normally be dealt by

- i) State Government thru their existing communication facilities such as Police network, HAM radio, SWAN, SAT phones and other such infrastructure already in place and with
- ii) Support from NDMA in terms of men and materials as indicated in these guidelines for establishing

communication for rescue and relief operations.

This chapter gives a general guideline as well as the supports provided by NDMA in terms of men and material. It also includes some suggested technologies, which can be adopted by the State Governments in the affected area.

10.2 Providing Need Based Communication Support

The phases of establishment and restoration of communication facilities are enumerated in the following paragraphs as a guideline. However, notwithstanding these guidelines, the State may initiate appropriate measures after assessing the extent of damage. Communication restoration in natural disaster scenarios

(that does not include the communication system to be established with special design features for its survival under EMP scenario)

can be viewed to be realised in three phases:

Phase-I: Emergency communication for providing immediate connectivity: within 15 minutes after reaching the site

Phase-II: Establishment of Mobile Emergency Operation Centre (MEOC) through NDRF for providing communication facility with adequate bandwidth for voice, video and data: within 3 hours after reaching the site

Phase-III: Operational requirement with complete restoration of communication : upto

7days with the assistance from the telecom service providers

10.2.1 Phase-I : Emergency Restoration of Communication Link (within fifteen minutes after reaching the site)

The basic need will be:

- i) To establish communication from the incident area to DC's office and NDMA Headquarters via satellite phone
- ii) To establish push-to-talk communication for the local authorities thru VHF (ensures communication even if service provider's network within the local area has broken down)

To meet the above objective, the Incident Commander from district authorities will carry a Mini Mobile Communication Pack (MMCP) (to be provided by NDMA as a part of NDCN in all MHP districts), which will help to establish the communication link with the District Collector within 15 minutes after reaching the disaster site. The following items will form part of the MMCP:

- i) Two satellite phones (INMARSAT BGAN terminals/INSAT phone) with capability to provide voice and data: Light weight (upto 3 kg), easy to carry to the incident area. Communication can be established within 15 minutes with DC's office /NDMA Headquarters. This will be supplied with spare battery in ready to use condition and battery charger. Transportable VSAT can be used for access to Internet for data transfer from the disaster site through the laptop provided.
- ii) One Laptop with encoding and streaming card

- iii) One VHF (25W) portable radio, 20 VHF Walkie-Talkie sets (in addition to sets for NDRF personnel engaged in rescue and relief operations) for providing push-to-talk communication among the local authorities within 1 hour after reaching the site. Any tall building in the affected area such as a school, disaster shelter can be utilised for fixing antenna on the rooftop and installing the equipment in an enclosure.
- iv) 2 KVA diesel generator set power pack , 1 KVA UPS ,connecting cable, extension boards, diesel container

10.2.2 Phase-II :Establishment of Communication Link with Added Bandwidth through MEOC by NDRF Battalion : (within 3 hrs after reaching the site in a graded manner)

In this phase, the requirement is to establish communication link with added bandwidth thru MEOC to be airflown in ready to use condition to provide

- i) For NDRF local Head Quarters
- ii) Communication among the teams of the battalion
- iii) Video coverage of disaster site & Instant communication from the disaster site to DC 's office/NDMA Head Quarters
- iv) Back-up power for communication equipment
- v) Communication between NDRF staff in the field, NDMA Head Quarters and local authorities

To meet the above objectives, NDRF is equipped with SAT phones, VHF radios, VSAT terminals, cellular mobile phones etc as detailed in para 7.7 and listed in Annexure 17. Vehicle mounted Mobile Emergency Operating Centre (MEOC) will be established at the incident area for which NDRF team will be moved to the area with specially built Mobile Communication Vehicle. The team may be required to camp for few days to weeks, depending upon the severity of calamity. The vehicle will be wired for ready-to-use condition housing following equipments. The whole package will be airlifted to minimize the time delay.

- i) Two satellite phones (INMARSAT BGAN terminals/INSAT phone) with capabilities: portable for immediate communication after reaching the site.
- ii) One VSAT terminal mounted on the vehicle and one flyaway satellite terminal for voice, video and data connectivity.
- iii) Portable VHF radio (25W) which can be fitted on any vehicle for communication with the NDRF teams while moving in the disaster hit area.
- iv) Base station (25W) along with walkie-talkie sets.
- v) Handycam : 1 no. with unit containing encoder & video streaming card for video coverage of the disaster site.
- vi) Laptop : 2 nos.
- vii) Diesel Generator Sets : 5KVA – 2 nos and UPS 2 KVS- 2nos . This will meet the requirement of emergency power

10.2.3 Phase-III : Operational Requirement with Full Restoration of Bandwidth : (up to 7days with assistance from the telecom service providers)

The objective in this phase is to return to normalcy as quick as possible. Depending upon the extent of damage, this activity may take several days. The first two phases mentioned above will provide the partial restoration of communication, mostly catering to the need of local authorities who will be involved in assessing the relief needed and implementing the relief measures. In this phase, the restoration of communication facilities for the public including local and long distance communication will be the primary objective.

Telecom service providers will initiate the necessary measures of restoring the communication links by repair/replacement of the equipments affected. The State Government will be assisting them in terms of infrastructural support for housing the equipment, reaching the site (if inaccessible) etc as required.

10.2.4 Incident Commander

Normally, an officer identified by the concerned DC (of the affected area) will be the Incident Commander at the disaster affected area (except in the event of a nuclear and radiological emergency, when DC/DM himself has to take charge of IC) and the proposed MMCP (Mini Mobile Communication Pack) will be handed over to him during the emergency. While he has to establish the communication link for immediate requirement through MMCP, he would also take charge of communication system to be air flown subsequently by NDRF to the area. Concerned officer from NDRF will report

to Incident Commander (after operationalising the equipment) and assist Incident Commander in all subsequent operations.

10.3 Suggested Actions at State/ UT level

The guiding principle behind the disaster management is the holistic management based on proactive process instead of traditional response centric approach. Hence, the approach of these National guidelines lays equal emphasis on preventive and mitigation measures.

As establishing a new robust telecommunication infrastructure to cover each and every part of the disaster area in the country is an herculean task, certain careful planning on the part of agencies at State /UT level, while building new telecom infrastructure as per the prevalent vulnerability profile, will immensely help in achieving the objective of covering everybody's need at all possible disaster affected areas. A few of such measures to be considered are discussed below.

10.3.1 Utilisation of Traditional Communication System

The agencies at state/UT level should adopt the traditional system often practiced by local communities as a part of their local coping mechanism. Communication through torchlight (night time) and smoke (daytime) in inaccessible tribal areas, mass addressing systems through community mikes installed in Masjids, Temples, Gurudwaras etc. are a few of such traditional communication mechanisms. This traditional mechanism offers opportunities to reach remote communities.

10.3.2 Communication for Fishermen Community

For fishermen going deep sea, the communication to the fishing boat can be provided based on satellite or VHF mode.

(i) Satellite based communication:

ISRO has developed INSAT based Disaster Alert Transmitter (DAT) for use in the fishing boats. DAT has been described in detail in chapter 3, (under para 3.2). In case of emergency, the fishing boat transmits a short message communicating its position and type of emergency to central locations at the earliest for rescue operation.

(ii) VHF based system:

Marine Radio VHF set is useful to establish voice calls and receive longitude/latitude position data at the shore station. It will also help to send weather forecast on impending cyclone to the fisherman on the craft. One such system planned to be implemented in Tamil Nadu has been briefed in chapter 3, (para 3.2).

10.3.3 Public Mobile Radio Network

Public Mobile Radios offer certain features like congestion free network, distress call etc., which the conventional Mobile systems like GSM/CDMA access technology cannot offer. Hence, PMR systems like Tetra are being predominantly used by Government agencies to provide such services. One such Government agency is police, for whom Tetra system offers innumerable advantages such as Group communications, Control room and dispatching operations, Secure communications,

Direct mode of operations in case of network failure etc. Some of the States are already implementing Tetra based police network for their communication. It is suggested the States may plan Tetra based secured communication network for the authorities like police, SDRF etc., as it will be easier to establish communication between various authorities during disaster.

10.3.4 Cyclone Resilient Mobile Towers

During cyclone disaster situation, the communication towers (which provide mobile connectivity in the area) normally suffer damages in severe cyclonic conditions (when wind speed may exceed about 180 km/hour). On account of this, the mobile telecommunication network is likely to be disrupted. Strengthening the towers by proper design to withstand higher wind speeds (of about 200km/hr) will help in avoiding the damages to the towers. Reputed organisations in structural design of towers can be entrusted with the job of providing an appropriate design for such special mobile towers and this design can be adopted by the Telecom Service Providers (while constructing the towers). It may involve additional expenditure compared to ordinary towers and funding of such cyclone resilient towers can be arranged for.

Universal Service Obligation Fund (USOF) has been set up in Department of Telecom for spreading telecommunication facilities in rural areas by providing subsidy. State Governments can take up with USOF authorities for working out a mechanism to provide subsidy to the Telecom Service Providers for erecting special mobile towers in rural areas, particularly, those bordering coastal line.

10.3.5 WiMAX Technology

Worldwide Interoperability of Microwave Access (WiMAX), is a wireless access service designed to cover wide geographical areas, serving large numbers of users at low cost providing IP connectivity. This is an emerging technology, which is getting standardized for converged application of providing voice, video and data in the last mile. As the service providers in India are introducing this technology in a progressive manner, the State Governments based on the topography and hazard profile for last mile connectivity can consider it for deployment.

10.3.6. Communication Platform for Protection from Floods

Raised platforms for housing the equipments to protect them from water entry

and avoid breakdown during flood situations should be considered particularly by the States/ UT's prone to periodical floods of high frequency and intensity

10.3.7 Multi-Task Riverine Ship for Disaster Management: Specific to Assam/West Bengal:

River Brahmaputra in Assam and Ganges in West Bengal create diverse flood situations disrupting land based communication leading to river routes as the only viable route for transport and travel during flood period. To meet the purpose of communication during disaster in such a scenario, use of ships/boats equipped with Mini Mobile Communication Pack as described in these guidelines under chapter 7 should be considered by the concerned States (for fast and efficient rescue and relief operations during flood situations).

11

Implementation of NDCN

11.1 Introduction

Implementation should ensure timely rollout of the NDCN network, meeting the appropriate standards as well as the quality of service. The activities in the implementation of NDCN will essentially center around four important segments viz;

- (a) Planning and execution of the Network (by the implementing agency).
- (b) Operational support (by SDMA/NDMA).
- (c) Training of manpower for operations (by NDMA/SDMA).
- (d) Network Maintenance (by the implementing agency for initial 5 years).

11.2 Planning and Execution of the Network (by Implementing Agency)

Considering the architecture of the network, which requires integration of various satellites, IT and interfacing equipments etc spread over large areas, it is recommended to carry out the implementation of NDCN as a turnkey project by a qualified implementing agency, to be appointed by NDMA.

All the activities such as procurement of equipment / system / components, installation, testing and commissioning of the equipments

including the technical maintenance for initial five years will be the responsibility of the implementation agency. This will ensure adherence to quality standards and proper up-keep of the network for its efficient use and availability. A suitable Project Management Group (PMG) at the National and State Level should be constituted to monitor the execution of the project.

11.3 Operational Support (by SDMA/NDMA)

To achieve the desired functions of NDCN, it is essential that suitable operational staff, which has been provided with the requisite technical knowledge of the network infrastructure, is entrusted with this task. The operational staff earmarked for the Emergency Operating Centre (EOC) will be responsible for collecting, analyzing and disseminating various types of data using NDCN for various phases of disaster continuum. The staff will be provided by NDMA for NEOC and by SDMAs / DDMA for SEOCs and DEOCs.

11.4 Training of Manpower for Operations (by NDMA/SDMA)

Establishment and subsequent operational maintenance of a complex and

dynamically responsive network like NDCN require appropriate operational staff that is familiar with the operations for its effective utilization. The manpower employed would have to be adequately trained and technologically updated at regular intervals. High level of availability of such a complex network involving very high end data storage, mining, procuring and visualization, would call for requisite training of the operational, administration and security management staff. It is only with continuous training, full scale potential of NDCN for effective disaster management would be utilized.

11.5 Network Maintenance of NDCN (by Implementing Agency for 5 years)

The stakeholders must be able to utilize the network with the assured bandwidth. There should be proper and regular monitoring to ensure that the availability of network and the leased bandwidth is above 99% for which the necessary SLAs are strictly to be adhered to by the service providers. Network Maintenance of NDCN, which consists of satellites, IT and other interfacing equipments, is quite involved to ensure proper functioning of the various types of equipments on 24x7 basis.

To derive all the benefits of NDCN, it would heavily depend on how the network is maintained 24x7. This responsibility can be entrusted with the implementing agency for a period of initial 5 years in order to ensure proper upkeep of the equipments, (by rectifying the faults as and when occur and carryout periodical functional tests).

Subsequently, the task can be taken over by the staff belonging to NDMA/SDMAs for

NEOC and SEOCs at State as well as district level by the operative staff of EOC's.

However, during management of live disasters, the staff (operational as well as technical support) would be inadequate for 24 X 7 operation of NDCN. The front-end management staff could be reinforced by suitably co-opting man power / experts from agencies like IMD, CWC, Police etc, along with some of the man power available at SDMA/ DDMA levels for round the clock manning of the Emergency Operation Centres. As regards back-end technical support staff, one could resort to Memorandum of Understanding and Service Level Agreement with various Service Providers to provide additional technical support staff during disasters. This could be based either on some agreed terms and conditions or even as a part of societal responsibility/ obligation on part of Service Providers at the national level/ state levels.

11.6 Funding Mechanism

The NDMICS project will be a centrally sponsored project to be funded by Central Ministry for implementation and subsequent Network Maintenance. However, the cost towards civil and electrical works (other than the communication equipment/infrastructure) and O&M cost for regular utilization of the infrastructures at SEOCs and DEOCs would be borne by the concerned states

11.7 Licenses and Clearances

All communication networks, which would be part of National Disaster Management Information and Communication System

(NDMICS), need to have licenses and clearances from Department of Telecommunications, Ministry of Communication and IT, for their operations and interconnections.

11.8 Action Points

- i) Constitution of suitable Project Management Group (PMG) at the National and State levels.
- ii) Preparation of RFPs and tender action at NDMA level.
- iii) Appointing an implementing agency to carry out all the activities such as installation, testing and commissioning of the equipments as a turnkey project and subsequent maintenance of the network and the associated equipments for a period of 5 years.
- iv) Inclusion of maintenance of the network and the associated equipments to be carried out for five years by the implementing agency appointed by NDMA.
- v) Involvement of States and Districts at the planning and implementation stage.
- vi) Central Government funding for the network equipment and related hardware and software while the civil / electrical infrastructure to be provided by respective State / Districts authorities.
- vii) Empowering NDRF battalions with communication linkages by NDMA.
- viii) Entering into MOU and SLA with various service providers(both government and private) by the State Governments for services as well as for obtaining additional technical support staff during disasters, if need arises.
- ix) Training of staff in the proper utilization of NDCN for operational and administration purposes during disasters.
- x) Preparation of SOP for various emergences and vulnerabilities for the complete DM continuum.
- xi) Planned utilization of NDCN during peacetime especially NDRF component including MEOC.
- xii) Allocation of resources for continued operation maintenance and dynamic updation of NDCN.
- xiii) Obtaining necessary licenses and clearances for operating the communication network from Department of Telecommunication, Ministry of Communication and IT.

12

Summary of Action Points

12.1 Introduction

National Disaster Management Guidelines for National Disaster Management Information and Communication System (NDMICS) have been covered in the preceding Chapters 1 to 11. These Chapters spell out the ICT Requirements and Characteristics along with the necessary structure in terms of organizational measures and the operational/functional matrix to ensure the desired communication and IT connectivity. Special features of GIS based value added NDMIS have also been highlighted that would provide the much needed information to the right person at the right time through NDCN project. To realize the full fledged potential of ICT planned under NDMICS, concrete actions at National, State and District levels are to be taken. A Summary of these 'Action Points' for various stakeholders are furnished below:

12.2 Action Points for NDMA

12.2.1 Planning

- (i) Planning should include operator and communication media diversity by connecting to more than one service providers as well as satellite connectivity for supplementing terrestrial connectivity (Ref: CH 5, para 5.9 (i))
- (ii) Utilisation of existing and planned National Terrestrial and Satellite

Infrastructure, whether public or private. (Ref : CH 5, para 5.9 (ii))

- (iii) Planning of overlay VSAT network to provide fail-safe character under all phases of disaster scenarios. (Ref: CH 5, para 5.9 (iii))
- (iv) Entering into SLA with the existing service providers for telecommunication network with required bandwidth provisioning in NDCN. [Ref: CH11 para 11.4]
- (v) Ensuring full integration of all satellite based as well as terrestrial network e.g., POLNET, NICNET, DMO & SWAN etc [Ref: CH3 para3.7(iii)]
- (vi) Finalization of the communication needs of MEOCs at site [Ref: CH7 para 7.8(i)]
- (vii) Coordination with States and Districts at the planning and implementation stage.
- (viii) Allocation of resources for continued operation maintenance and dynamic updation of NDCN [Ref: CH11 para11.7(xii)]
- (ix) Establishment of NDMIS on GIS platform to perform Vulnerability Analysis And Risk Assessment and to generate Decision Support System for holistic management of DM, [Ref: CH3 para 3.8 (iv)]

- (x) Induction of new technology equipments such as portable Microcellular system, Tetra system, Generic RF repeater system for the disaster situation depending on the experience gained in the utilization of the present planned equipments. [Ref: CH7 para 7.8 (ii)]
- (xi) Exploration possibility of the latest development of rapidly deployable Wireless Mesh Networks based on 802.11 standards, future expansion of the last mile connectivity with such networks should be explored as and when they are commercially available for large scale deployment. [Ref: CH9 para 9.6(iii)]

12.2.2 Implementation of NDCN

- (i) Constitution of suitable Project Management Group (PMG) at the National and State levels [Ref: CH11 para 11.7 (i)]
- (ii) Preparation of DPR, RFPs and tendering actions [Ref: CH11 para 11.7 (ii)]
- (iii) Appointing an implementing agency for carrying out all the activities as a turnkey project and subsequent maintenance of the network and the associated equipments for a period of 5 years [Ref: CH11 para 11.7 (iii)]
- (iv) Planning for the utilization of NDCN during peace time, especially NDRF component including MEOC [Ref: CH11 para 11.7 (xi)]
- (v) Taking up with ISRO and DoT(WPC/Licensing) for the allotment of frequency spectrum in Ku-band (satellite) and VHF band including the permission to

operate INMARSAT BGAN terminals [Ref: CH9 para 9.6 (iv)]

12.2.3 Implementation of Data Fusion Center (NDMIS) on GIS platform

- (i) Development of digital Cartographic Base at the appropriate scales and contour intervals [Ref: CH4 para 4.8.12(i)]
- (ii) Upgradation of hazard maps of India with respect to various natural hazards (in term of locations, frequency, duration and intensity) to be obtained [Ref: CH4 para 4.8.12 (ii)]
- (iii) Establishment of the necessary computational and data handling hardware along with necessary software, for development of various applications on the GIS-platform to empower the stakeholders (for pre-, during-, and post - disaster scenarios). [Ref: CH4 para 4.8.12 (iii)]
- (iv) Development of Vulnerability Analysis & Risk Access Tools (VA&RA) [Ref: CH4 para 4.8.12 (iv)]
- (v) Development for Decision Support System(DSS) Tool [Ref: CH4 para 4.8.12 (v)]

12.3 Action Points for Implementing Agency

- (i) Establishment of Emergency Operation Centres at State and District levels with requisite facilities in consultation with respective authorities. [Ref: CH7 para 7.8 (iv)]
- (ii) Installation, testing and commissioning of the equipments. [Ref: CH11 para 11.7 (iii)]

- (iii) Assisting NDMA for reliability of NDCN (to be ensured through adequate bandwidth availability) through appropriate Service Level Agreements (SLAs) with various operators. [Ref: CH11 para 11.4]
 - (iv) Maintenance of the network and associated equipments will be carried out for 5 years. [Ref: CH11 para 11.7 (iv)]
 - (v) Establishment of NOC at NEOC to visualize Network availability and monitoring of Bandwidth Availability as per SLA entered into.
 - (vi) Training of staff in the operational and management of NDCN for full utilization of NDCN. [Ref: CH11 para 11.7 (ix)]
 - (vii) Development of NDMA portal with modules for group messaging system, incident reporting system, resource analysis and relief needs and system administration. [Ref: CH6 para 6.9 (i)]
 - (viii) Assisting NDMA/SDMAs in development of application system at NEOC, SEOC and DEOC. [Ref: CH6 para 6.9 (ii)]
 - (ix) Creation of data base at SEOC and DEOC with information such as vulnerable districts, canal, relief material and shelter details etc. [Ref: CH6 para 6.9 (iii)]
 - (x) Establishment of State level Websites and Call Centres / Help Lines, specifically pertaining to disasters. These of necessity will have to be multi lingual (Hindi, English and State specific language). [Ref: CH8 para 8.9 (i)]
 - (xi) Working out host of measures and support initiatives such training, logistic support for maintenance, power backup especially at the disaster site, issues regarding spectrum/frequency allocation and data updation for the establishment of NDCN [Ref: CH8 para 8.9 (ii)]
 - (xii) Preparation of SOP for utilization of NDCN towards various application over the complete DM continuum. [Ref: CH11 para 11.7 (x)]
 - (xiii) Maintaining stakeholders contact details: mobile numbers, land line numbers, E-mail address, official / residential address, in the form of a dynamically updated directory. These should also include details of officiating incumbents / next in chain of responsibility during absence of permanent incumbent at the respective EOCs at National, State and District levels. [Ref: CH6 para 6.9 (v)]
- ## 12.4 Action Points for State Governments
- (i) Constitution of suitable Project Management Group (PMG) at State as well as District levels for coordination in the implementation of NDCN
 - (ii) Identification and training of staff for making use of NDCN for disaster management
 - (iii) Speedy establishment of SWANs [Ref: CH3 para 3.7 (v)]
 - (iv) Establishment of SEOC and DEOCs as per needs of NDCN: while the network equipment and related hardware and

software would be catered for centrally, the civil / electrical infrastructure would have to be provisioned under respective State / Districts establishments [Ref: CH11 para 11.7 (vi)]

- (v) Entering into MOU and SLA with various service providers (both government and private) by the State governments for the services as well as for obtaining additional technical support staff from them during disasters, if need arises. [Ref: CH11 para 11.7(viii)]

12.4.1 Other Recommended Action Points

- (i) Planning communication for fishermen community by the State Governments [Ref: CH10 para 10.3.2]
- (ii) Planning transportable microwave link /optical fiber systems as temporary measure for connecting to the nearest town (and then to national network) by the State Governments by entering into an arrangement with the service providers in the area [Ref: CH7 para 7.8 (iii)]
- (iii) Planning of Public Mobile Radios such as Tetra, which offer certain features

like congestion-free traffic, distress call etc (not offered by conventional mobile systems like GSM) for local police/fire safety network can be taken up by State Governments [Ref: CH10 para 10.3.3]

- (iv) Raising the platforms for housing the equipments to protect them from water entry and avoid breakdown during flood situations [Ref: CH10 para 10.3.6]
- (v) Erecting special mobile towers in rural areas especially bordering coastal line by the State Governments with the coordination of Universal Service Obligation Fund (USOF) authorities to provide subsidy to the telecomm service providers. [Ref: CH10 para 10.3.4]
- (vi) Design of cyclone resilient mobile towers (which can withstand higher speeds exceeding 180km/hour) with the help of reputed organisation in structural design of towers. [Ref: CH10 para 10.3.4]

PARADIGM SHIFT IN GLOBAL APPROACH TO DM

Considering the huge impact of natural disasters that have resulted in large number of deaths and caused considerable damage to property and infrastructure & environment worldwide, especially in developing countries, it was decided in UN general assembly on 11th December, 1987 to declare 1990s as the International Decade for Natural Disaster Reduction through international cooperation for saving human lives and reduce the impact of natural disasters.

Later on, in its meeting of 22nd December, 1989, UN General Assembly proclaimed the International Decade for Natural Disaster Reduction, beginning on 1 January 1990; and adopted the necessary “International Framework of Action” for this Decade for this purpose. The objective of the International Decade for Natural Disaster Reduction was to reduce through concerted international action, especially in developing countries, the loss of life, damage to property and disruption of social and economic environment caused by natural disasters.

The goals of the Decade were, inter alia, (i) to improve the capacity of each country to mitigate the effects of natural disasters expeditiously and effectively, paying special attention to assisting developing countries in the assessment of disaster damage potential and in the establishment of early warning systems and disaster-resistant structures when and where needed; (ii) to devise appropriate guidelines and strategies for applying existing scientific and technical knowledge, taking into account the cultural and economic diversity among nations; (iii) to foster scientific and engineering endeavours aimed at closing critical gaps in knowledge in order to reduce loss of life and property and (iv) to disseminate existing and new technical information related to measures for the assessment, prediction and mitigation of natural disasters;

Accordingly, all Governments were called upon inter alia,

- (i) to formulate national disaster-mitigation programmes, as well as economic, land use and insurance policies for disaster prevention, and, particularly in developing countries, to integrate them fully into their national development programmes and

- (ii) to take measures, as appropriate, to increase public awareness of damage risk probabilities and of the significance of preparedness, prevention, relief and short-term recovery activities with respect to natural disasters and to enhance community preparedness through education, training and other means, taking into account the specific role of the news media.

In order to assess the status of disaster reduction midway into the decade and to work out the strategy and plan of action for a safer world, the world conference on Natural Disaster Reduction in the city of Yokohama, Japan (23rd – 27th May, 1994) affirmed, inter alia, that

- (i) Disaster prevention, mitigation, preparedness and relief are four elements, which contribute to and gain from the implementation of sustainable development policies. These elements, along with environmental protection and sustainable development, are closely interrelated. Therefore, nations should incorporate them in their development plans and ensure efficient follow-up measures at the community, national, sub-regional, and international levels.
- (ii) Disaster prevention, mitigation and preparedness are better than disaster response in achieving the goals and objectives of the Decade. Disaster response alone is not sufficient, as it yields only temporary results at a very high cost. Prevention contributes to lasting improvement in safety and is essential to the integrated disaster management and;
- (iii) Community involvement and their active participation should be encouraged in order to gain greater insight into the individual and collective perception of development and risk, and to have a clear understanding of the cultural and organizational characteristics of each society as well as of its behaviour and interactions with the physical and natural environment.

FIVE LEVELS OF SECURITY FOR NDMICS

Level-1 Security (Via Encrypted VPN)

Encryption of the transmitted data is one of the steps to be performed to make the WAN links more secure. It is also necessary to ensure that the encryption is not static but dynamic and varying based on communicating nodes and sessions. This is realized by implementing a Virtual Private Network (VPN), which encapsulates the IP based data exchange between the network nodes within the encrypted channel.

The terrestrial backup link between the NRSC and NDMA nodes also requires to be similarly secured.

Level-2 Security (For LAN at Node Level via a Fire Wall)

Network security refers to the security aspects related to the local area networks at the NDMIS nodes. The internal systems of an NDMIS node are connected to the external WAN interface via the router. The passage of all data packets through a firewall is mandatory.

The firewall has two internal segments - the demilitarized zone (DMZ) and the internal more secure militarized zone (MZ). More stringent rules are enforced for packets transmission to/from the internal MZ network and also many protocols, applications or port numbers are restricted or disabled. The DMZ houses the reverse proxy server, web/ file upload server, *DNS*/ mail server, Network Management System and the VOIP manager.

Though application servers within the internal network serve the actual responses to the user requests, the reverse proxy makes this transparent to the outside world. The reverse proxy is utilised in hiding the internal network details from the external users, which contributes to enhanced security.

Level-3 Security (Electronics Segregation of Different Functional Network)

Since the core network segment contains the actual NDMIS database repository, additional security and isolation is called for. Hence, this segment is further protected by an appropriately configured firewall. A high performance Gigabit Layer 3 switch is provided, which facilitates configuration of access control lists between the network segments in the NDMIS zone.

Level-4 Security (Via Antivirus Solution at System Level)

Number of security measures are necessary. The operating systems in their default configuration states are vulnerable to many security threats like open ports, default passwords,

etc., which need to be plugged as a mandatory process.

Host level antivirus solution is placed wherever network solutions are absent or inadequate to stronger security at individual system level.

Level-5 Security (Via Physical Access and Password Controls)

i) Physical Security

Physical security is an important component in the security infrastructure. The core server and storage systems are located in a physically secure space with physical access control implemented using biometric smart card mechanisms. The various other network segments and WAN communication interface equipment are segregated into physically separate spaces with individual access controls. This ensures streamlined management of access to different functional areas by only the relevant staff. The rack enclosures and desktop servers are further protected by lock & key mechanisms.

ii) Data and Application Access Security

Configuring users and assigning appropriate authorizations or rights to allow them to execute certain applications or database operations is very crucial in assuring robust security for the NDMIS database. For example, most users would be allowed to make general queries of metadata, but only selected groups can access high resolution data sets or execute data ingest or delete operations.

User access to NDMIS database and applications is governed by robust authentication and access control mechanisms for which the NDMIS users are provided with unique multi-factor identification parameters based on a combination of username, password, RSA tokens, smart cards, biometric Ids, etc.

TELECOMMUNICATION SYSTEM: TECHNOLOGY ASPECTS

1. Multiplexing

It is the process of combining a number of signals into a single format so that they can be processed by a single amplifier or transmitted over a pair of copper cable or optic fiber or a single radio channel. The advantage of this technique is that a number of users can effectively utilize a common resource by sharing but at the same meeting their requirements.

If it is done in frequency domain, by assigning different frequencies for each individual signal, it is called Frequency Division Multiplexing (FDM) which is prevalent mostly in analog transmission systems

If the multiplexing is carried out in time domain by allotting different time slots in a frame for each individual signal, it is known as Time Division Multiplexing (TDM). This technique is predominantly used in the modern telecommunication network which are digital. By using TDM technique in the form of Pulse Code Modulation (PCM), 30 telephone subscribers can be accommodated on a single copper pair instead of individual pairs for their communication.

2. Modulation Techniques

Modulation is the process to facilitate the transfer of information over a medium using a carrier. In other words, modulation is the addition of information (or the signal) to an electrical or optical signal carrier. The characteristics of the carrier signal (amplitude, frequency, phase) are varied in accordance with the different strength or level of the information signal. The medium can be copper cable, wireless or optic fiber.

Conventionally there are three basic modulation techniques distinguished by the type of modulation on the carrier. When the amplitude of the carrier is varied, it is known as Amplitude modulation (AM) and the frequency is varied in tune with the amplitude of the information signal, then it is Frequency Modulation (FM). In Phase Modulation (PM), the phase variation of the carrier is done and Phase Shift Keying (PSK) is a form of this type of modulation.

In optical modulation, the output of the light source, e.g Laser, is varied as per the value of current of the information signal.

In telecommunication networks, FM and PSK modulation techniques have found wide application. In today's digital environment, there is predominant use of PSK and light modulation.

2.1 PSK (Phase Shift Keying) modulation

In PSK, the phase of the carrier is varied in accordance with the amplitude of information signal. PSK modulation technique is widely used in digital transmission systems.

Depending on the number of phases used, the modulation is referred as BPSK (BI-phase Shift Keying), QPSK (Quadrature Phase Shift Keying) etc. When both phase and amplitude states are used, it is called QAM. Terminology 'symbol rate' is used in a satellite link design. Symbol is a phase state or a phase and amplitude state. Or in other words, a symbol is defined by the rate at which information is sent over the link in the form of changes in phase angle of a carrier. Digital bit rates are indicated as symbol rates in design calculation and one symbol can carry more than one bit. For example in BPSK, where only two phases are used, one symbol carries one bit. In QPSK where four phases are used for modulation, one symbol carries two bits. In 16 QAM, which combines four phase states with four pulse amplitude states, each symbol carries four bits. When we use PSK modulation, the bandwidth capacity is indicated by the symbol rate. For BPSK, the bit rate capacity is same as symbol rate. The actual bit rate carried by the system increases for higher level of modulation such as QPSK, 16QAM, 64QAM. For example, since each symbol carries two bits in a QPSK, the bit rate capacity is twice that of BPSK. Thus in the same bandwidth higher bit rate capacity can be achieved by employing higher level of modulation.

PSK modulation techniques find wide application in microwave, cellular mobile radio and satellite communication networks.

2.2 Base Band Formation and Modulation

Baseband is formed using the multiplexing technique and the baseband modulates a carrier to share the medium such as sharing the bandwidth in a satellite transponder.

3. Multiple Access (for wireless system)

Multiple access is the methodology adopted in Wireless system to enable several users in the coverage area to individually access the system using wireless access. There are three basic multiple access techniques employed in telecommunication networks and these are:

3.1 Frequency Division Multiple Access (FDMA)

All users/terminals share the bandwidth at the same time by transmitting at an individually allocated carrier frequency. Distinction between the users/terminals is made by allotting different carrier frequencies in the frequency band. Each user/terminal occupies a bandwidth slot assigned to its operating carrier frequency.

3.2 Time Division Multiple Access (TDMA)

Each user is allocated a unique time slot so that the different users access the bandwidth sequentially in time transmitting on the same frequency. Distinction between users/terminals is

maintained by assigning different time slots in a frame. One sequence of individual time slots from the users will constitute a frame and transmission continues by users transmitting in time slots frame after frame.

3.3 Code Division Multiple Access (CDMA)

All users/terminals transmit at the same frequency and at the same time with orthogonally coded spread spectrum signals that can be separated at the receiving station by correlation with the transmitting code. Distinction is made between users/terminals by assigning different orthogonal codes

4. Synchronous Digital Hierarchy (SDH)

SDH provides the synchronous form in transmission networks, which is needed to achieve higher bit rates in gigabits range (using optical fiber systems). It provides hierarchy at different transmission speed. SDH based on standardised format has provided transmission networks with a vendor-independent and sophisticated signal structure that has a rich feature set to provide integrated Network Monitoring System (NMS) covering Fault management, Performance management, Configuration management etc. This has resulted in new network applications and network topologies and management by operations systems of much greater power than previously seen in transmission networks. With the improved operations management of networks on account of SDH systems, reduction in the network operating cost could be achieved.

SDH uses the following Synchronous Transport Modules (STM) as basic unit for transmission. STM-1 supports the speed of 155 megabits per second. The higher speeds are in multiples of four namely STM-4 (622 Mbps), STM-16 (2.5 gigabits per second), and STM-64 (10 Gbps).

Appendix –IV

OPEN SYSTEM INTERCONNECTION (OSI) REFERENCE MODEL FOR NETWORK ARCHITECTURE

1. Introduction

Open System Interconnection (OSI) model for Network Architecture is an abstract description for layered communications and computer network protocol design. It was developed, as part of the Open System Interconnection (OSI) initiative, by International Organization for Standardization (ISO). OSI has two major components viz (i): seven- layer model called basic reference model and (ii) set of specific protocols. Protocols enable an entity in one host (user) to interact with a corresponding entity at the same layer in another host.

In its most basic form, it divides network architecture into seven layers which, from top to bottom, are the Application, Presentation, Session, Transport, Network, Data-Link, and Physical Layers. It is, therefore, often referred to as the OSI Seven Layer Model.

A layer is a collection of conceptually similar functions that provides services to the layer above it and receives services from the layer below it. On each layer an instance provides services to the instances at the layer above and requests service from the layer below. For example, a layer that provides error-free communications across a network provides the path needed by applications above it, while it calls the next lower layer to send and receive packets that make up the contents of the path.

2. Description of OSI layers

OSI Model				
	Data unit		Layer	Function
Host layers		7.	Application	Network process to application
	Data	6.	Presentation	Data representation and encryption
		5.	Session	Interhost communication
	Segment	4.	Transport	End to end connections and reliability
Media layers	Packet	3.	Network	Path determination and logical addressing
	Frame	2.	Data Link	Physical addressing
	Bit	1.	Physical	Media, signal and binary transmission

Layer 1: Physical Layer

Physical Layer defines the electrical and physical specifications for devices. In particular, it defines the Relationship between a device and a physical medium. This includes the layout of

pins, voltages, cable specifications, repeaters, network adapters, etc.

Layer 2: Data Link Layer

Data Link Layer provides the functional and procedural means to transfer data between network entities and to detect and possibly correct errors that may occur in the Physical Layer. e.g. Frame relay, ARP etc.

Layer 3: Network Layer

Network Layer provides the functional and procedural means of transferring variable length data sequences from a source to a destination (via one or more networks), while maintaining the quality of service requested by the Transport Layer. Routers operate in this layer- sending data throughout the network, thus making the Internet possible.

The best-known example of a layer 3 protocol is the Internet Protocol (IP). It manages the connectionless transfer of data, one hop at a time from dispatch end system to ingress router, router to router, and from ingress router to destination end system. It is responsible for reliable delivery to a next hop, but only for the detection of errored packets, so that these may be discarded.

Layer 4: Transport Layer

Transport Layer provides transparent transfer of data between end users, providing reliable data transfer services to the upper layer. The Transport Layer controls the reliability of a given link through flow control, segmentation/ desegmentation, and error control. Examples of Layer 4 are the Transmission Control Protocol (TCP) and User Datagram Protocol (UDP).

Layer 5: Session Layer

Session Layer controls the dialogue connections between computers. It establishes, manages and terminates the connection between the local and remote application.

Layer 6: Presentation Layer

Presentation Layer establishes a context between Application Layer entities, in which the higher layer entities can use different syntax and semantics, as long as the presentation service understands both and the mapping between them. The presentation layer works to transform data into the form that the application layer can accept. This layer formats and encrypts data to be sent across a network, providing freedom from compatibility problems.

Layer 7: Application Layer

Application Layer is the OSI Layer closest to the end user, which means that both the OSI application layers and the users interact directly with the software application. Application layer functions typically include identifying communication partners, determining resources availability and synchronizing communication. Some examples of application layer implementation include Hypertext Transfer Protocol, (HTTP), File Transfer Protocol (FTP) and Simple Mail Transfer Protocol (SMTP).

Appendix -V

CONVERGENCE TECHNOLOGIES (FOR VOICE, VIDEO & DATA)

1. Introduction

Traditionally the telecommunication networks are optimised for carrying voice traffic using circuit switching, while data networks have been designed to carry non-voice services (video, data etc) employing packet switching. With the advent of internet, which is router based network, there has been the need to integrate voice, video, data, on a single network and packet switching technology has enabled to achieve this objective.

2. Circuit switching

It normally refers to a telephone network Communication Protocol in PSTN (Public Switched Telephone Network) in which the telephone calls are switched between two users, using a dedicated circuit connection. The important thing to look for in transmitting information over a complex network is the path or circuit. The devices making up the path are called nodes. For instance, switches and some other network devices are nodes. In circuit-switching, this path is decided upon before the information transmission starts. The system decides on which route to follow, based on a resource-optimizing algorithm, and transmission goes according to the path. It follows connection-oriented technique. For the whole length of the communication session between the two communicating bodies, the route is dedicated and exclusive, and released only when the session terminates. The circuit resources are dedicated for the entire duration of the session.

Resources remain allocated during the full length of a communication, after a circuit is established and until the circuit is terminated and the allocated resources are freed. Resources remain allocated even if no data is flowing on a circuit, hereby wasting link capacity when a circuit does not carry as much traffic as the allocation permits.

3. Integrated Services Digital Network (ISDN)

ISDN is a system of digital phone connections, which has been available since 1990. This system allows voice and data to be transmitted simultaneously through digital telephone exchanges across the world using end-to-end digital connectivity. It provides circuit switched connections.

ISDN allows multiple devices to share a single line. It is possible to combine many different digital data sources and have the information routed to the proper destination. Since the line is digital, it is easier to keep the noise and interference out while combining these signals. ISDN technically refers to a specific set of digital services provided through a single, standard interface. Without ISDN, distinct interfaces are required instead.

ISDN allows multiple digital channels to be operated simultaneously through the same regular phone wiring used for analog lines but switched through new type telephone exchanges supporting digital connections. Therefore, the same physical wiring can be used, but a digital signal, instead of an analog signal, is transmitted across the line. There are two basic types of ISDN service: Basic Rate Interface (BRI) and Primary Rate Interface (PRI). To access Basic Rate Interface (BRI) service, the customer has to necessarily subscribe to an ISDN phone line. Customers will also need special equipment called Terminal Adapters to communicate with the digital exchange switch.

With ISDN, voice and data are carried by bearer channels (B channels) occupying a bandwidth of 64 kb/s. A data channel (D channel) handles signaling at 16 kb/s or 64 kb/s, depending on the service type (BRI or PRI).

BRI consists of two 64 kb/s B channels and one 16 kb/s D channel for a total bit rate of 144 kb/s, i.e two simultaneous telephone line and a data channel. This basic service is intended to meet the needs of most individual users.

PRI is intended for users with greater capacity requirements. Typically the channel structure is 30 B channels of 64 kb/s each plus one 64 kb/s D channel for a total bit rate of nearly 2 Mb/s

Most recently, ISDN service has largely been displaced by broadband internet service, such as xDSL and Cable Modem service. These services are faster, less expensive, and easier to set up and maintain than ISDN. Still, ISDN has its place, as backup to dedicated lines, and in locations where broadband service is not yet available.

4. Packet Switching

Packet switching refers to protocols in which messages are divided into packets before they are sent. Each packet is then transmitted individually and can even follow different routes to its destination. Once, all the packets forming a message arrive at the destination, they are recompiled into the original message. Unlike circuit switching, the resources in the network are utilized as per demand and they are shared by the users as per design of the network for meeting the QoS (Quality of Service) requirements.

The challenge for the telecommunication network has been meeting varying QoS requirements for voice and non-voice services. Voice traffic is delay-sensitive but loss-tolerant and concern with man-man communication. On the other hand, data traffic is error/loss sensitive but delay-tolerant and characterized by client-server mode of communication. Voice traffic have been traditionally carried by circuit-switched network requiring connection-oriented link and fixed guaranteed bandwidth. Data traffic are carried by packet switched networks which are conventionally connectionless and provides variable bandwidth.

MPLS (Multi Protocol Label Switching) is predominantly employed in packet switched networks. Thus multi services platform for carrying various services on a single network could

be achieved through packet switching. Applications of packet switching technology are the VoIP (Voice Over Internet Protocol) network and multi service network for carrying voice, video and data traffic

5. Multi Protocol Label Switching (MPLS)

MPLS (Multi Protocol Label Switching) is a packet switching technology, which is capable of carrying delay- sensitive traffic (like voice) as well as loss sensitive traffic (like data) by creating connection oriented virtual paths (for voice traffic).

MPLS is emerging as a multi-service network technology. MPLS establishes Label Switch Paths, which provides switching based on the contents of the Label attached to the packet, and which helps to guarantee a certain level of performance, to route around network congestion, or to create IP tunnels for Virtual Private Networks. Label Switched Paths can be established that crosses multiple layer 2 transports such as ATM, Frame Relay or Ethernet. Thus MPLS has the ability to create end-to-end circuits, with specific performance characteristics, across any type of transport, medium, eliminating the need for overlay networks or Layer 2 only control mechanism.

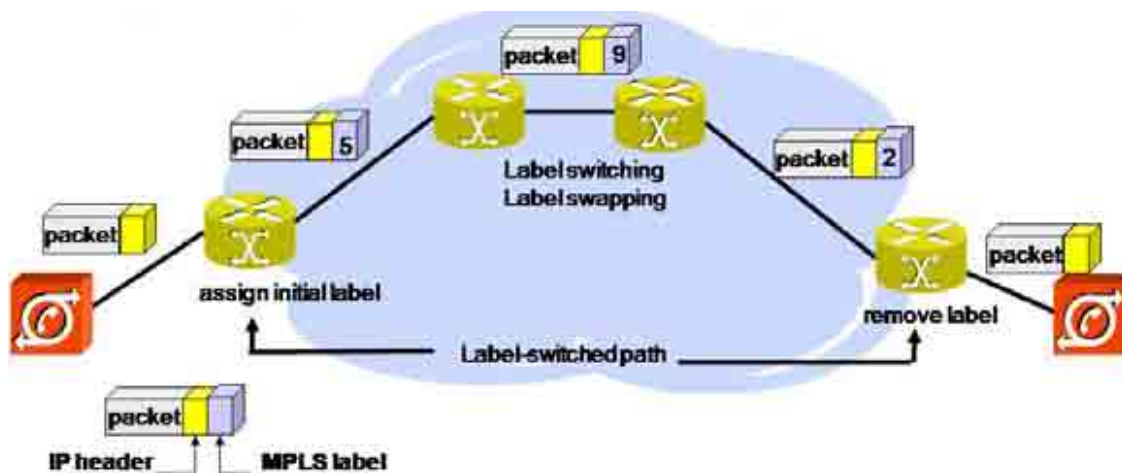

MPLS network consists of Label Edge Routers (LER) and Label Switching Routers (LSR). LER analysis IP header to decide Label Switched Path (LSP). LER add corresponding local LSP identifier in the form of a label. Other nodes forward the packet along LSP identified by the label. Original IP header fields are swapped transparently. The label simplifies forwarding by the nodes. It results in small table of labels, faster route lookup and faster switching time. Quality of class of DiffServ may be transported in MPLS header. Different paths can be defined based on QoS type

Some of the basic advantages of MPLS networks are as follows:-

- (i) **Traffic Engineering.** The ability to set the path that the traffic will take through the network and the ability to set performance characteristics for a class of traffic.
- (ii) **VPNs.** Using MPLS, we can create IP tunnels throughout the network.

- (iii) **Elimination of Multiple Layers.** Using MPLS, many of the functions will reduce in layer-2, thereby simplifying network management and network complexities.
- (iv) **Quality of Service (QoS).** MPLS makes it possible to apply QoS across very large routed or switched network because we can designate sets or labels that have special meanings, such as service class.

6. Protocols

Protocol is a set of rules, which is used by the equipments to communicate with each other. A protocol is a conversation or standard that controls or enable the connection, communication and data transfer between two endpoints. Protocol may be implemented by hardware, software or combination of both. In simple terms one can say that protocol defines the behavior of a hardware connection.

6.1 Internet Protocol (IP)

Internet is basically formed out of one or more network linked together. The glue that holds the internet together is network layer protocol i.e., Internet Protocol (IP). Unlike older network layer protocol, it is designed from the very beginning with internetworking in mind.

The transport layer takes data streams and breaks them into datagrams; each datagram is transmitted through the Internet, possibly being fragmented into smaller units. When all the pieces finally get to the destination machine, they are reassembled by the network layer into the original datagram. This datagram is then handed to the transport layer, which inserts into the receiving process input stream.

IP enables to provide a best- effort way to transport “datagrams” from source to destination, regardless of whether or not the machines are on the same network, or whether or not there are other network in between them

6.2 Internet Transport Protocol

The internet transport protocol has two main protocols in the transport layer: Transmission Control Protocol (TCP) and User Data Protocol (UDP).

6.2.1 Transmission Control Protocol (TCP)

This is a connection oriented protocol which was specifically designed to provide byte stream over a reliable end-to-end unreliable internetwork. An internetwork differs from a single network because different parts may have different topology bandwidths, delays, packet sizes, and other parameters. TCP was designed to dynamically adapt to properties of the internetwork and to be robust in the face of many kinds of failures.

Each machine supporting TCP has a TCP transport entity, which accepts users data stream from local processes, breaks them into pieces not exceeding 64 Kbytes (in practice usually about

1500 bytes), and sends each piece as a separate IP datagram. When IP datagrams containing TCP data arrive at a machine, they are given to the TCP entity, which reconstructs original byte streams. In general TCP means TCP transport entity which is a piece of software or TCP protocol which is a set of rules.

IP Layer gives no guarantee that datagrams will be delivered properly; hence, it is up to TCP to timeout and retransmits. Similarly, Datagrams may arrive in the wrong order. It is also up to TCP to reassemble them into messages in the proper sequence. In short TCP must furnish the reliability the most users want which IP does not provide.

TCP/IP model of the Internet protocols are not as rigidly designed into strict layers as the OSI model. TCP/IP does recognize four broad layers of functionality, viz: the scope of the software application, the end-to-end transport connection, the internetworking range, and lastly the scope of the direct links to other nodes on the local network.

Even though the concept is different than in OSI, these layers are nevertheless often compared with the layering scheme in the following way: The Internet Application Layer includes the OSI Application Layer, Presentation Layer, and most of the Session Layer. Its end-to-end Transport Layer includes the graceful close function of the OSI Session Layer as well as the OSI Transport Layer. The Internet working layer (Internet Layer) is a subset of the OSI Network Layer, while the Link Layer includes the OSI Data Link and Physical Layer as well as parts of OSI's Network Layer.

6.2.2 User Data Protocol (UDP)

UDP user data protocol is a connectionless transport protocol. It provides a way for applications to send encapsulated raw IP datagrams and send them without having to establish a connection.

6.3. Voice Over Internet Protocol (VoIP)

Internet Protocol (IP), due to its flexibility, ubiquity and availability of enormous applications developed around it, is all set to become a means to build a unified network infrastructure for voice and data in a flexible and economical way.

The Technology for running voice, fax and related services over Packet Switch IP-based Network is called **VoIP**. In this technology, the voice is digitized and transported in the network as packets. Since packets undergo delay while passing through the nodes in the network, voice packets are given higher priority than the data packets at each node of the network to ensure minimum/constant delay and sent to destination. At the destination end, voice packets received from the network are reassembled and routed to the receiver telephone. Thus, **a full duplex conversation** is achieved on **real time basis**.

NATIONAL ALLOCATION OF SPECTRUM

1. Spectrum for 2G

- 890-915 MHz paired with 935-960 MHz and 1710-1785 MHz paired with 1805-1880 MHz for GSM based networks.
- 824-844 MHz paired with 869-889 MHz for CDMA based 2G networks.

2. Spectrum for 3G

- 1920-1980 MHz paired with 2110-2170 MHz.
- The requirement of International Mobile Telecommunication (IMT) applications in the frequency band 450.5-457.5 MHz paired with 460.5-467.5 MHz is considered for coordination on a case by case basis subject to its availability.

3. Auction for 3G/EVDO/BWA

- Three blocks each of 5+5 MHz in 2.1 GHz band (i.e. 1920-1980 MHz paired with 2110-2170 MHz) in 17 telecom circles and four blocks each of 5+5 MHz in rest of the 5 telecom circles (excluding one block to MTNL and BSNL) have been e-auctioned for 3G spectrum by the Government.
- Two blocks each of 20 MHz in 2.5 GHz and 2.3 GHz bands (TDD mode) in 22 telecom circles (excluding one block to MTNL and BSNL) have been e-auctioned by the Government for Broadband Wireless Access(BWA).
- Spectrum shall be auctioned in the blocks of 2X1.25 MHz in 800 MHz band for Evolution Data Optimized (EVDO) services when it becomes available.
- Spectrum in 700 MHz band and 3.3 -3.6 GHz bands for BWA services shall also be auctioned as and when it becomes available.

4. Spectrum already allotted for 3G and BWA to BSNL/MTNL

- 2X5 MHz in 2.1 GHz band for 3G.
- 20 MHz in 2.5 GHz band for BWA.

5. Spectrum Earmark for Public Protection and Disaster Relief (PPDR) Communication:

- Requirement of public protection and disaster relief (PPDR) communications is proposed to be considered, as far as possible, in the frequency bands 380-400 MHz, 406.1-430MHz, 440-470MHz, 746-806MHz, 806-824/851-869 MHz, 4940-4990MHz and 5850-5925MHz on a case by case basis depending on specific need and equipments availability.

6 Exempted Frequency Bands Relevant to Last Mile Connectivity

- Use of low power equipments in the frequency band 2.4-2.4835 GHz using a maximum transmitter output power of 1 Watt (4 Watts Effective Radiated Power) with spectrum spread of 10 MHz or higher has been exempted from licensing requirement (see also GSR 45E dated 28.1.2005).
- The requirement of very low power radio gadgets, radio toys, etc with maximum power of 100 Microwatts are proposed to be considered in the frequency band 5725-5875 MHz. Such use will be on non-interference, non-protection and shared (non-exclusiveness) basis for indoor use only.
- Use of low power equipments in the frequency band 5.825 to 5.875 GHz using a maximum transmitter output power of 1 Watt (4 Watts Effective Radiated Power) with spectrum spread of 10 MHz or higher has been exempted from licensing requirements (See also GSR no 38E dated 19.1.2007).
- Use of low power equipments for cellular telecom systems including Radio Local Area Networks, in the frequency band 5.150-5.350 GHz and 5.725-5.875 GHz using a maximum mean Effective Isotropic Radiated Power of 200 mW and a maximum mean Effective Isotropic Radiated Power density of 10 mW/MHz in any 1 MHz bandwidth, for the indoor applications has been exempted from licensing requirement (See also GSR No 46E dated 28.1.2005).
- Use of low power Radio Frequency devices or equipments including Radio Frequency Identification Devices in the frequency band 865-867 MHz with a maximum transmitter power of 1 Watt (4 Watts Effective Radiated Power) with 200 KHz carrier bandwidth has been exempted from licensing requirement [See also GSR 564 (E) dated 30 July 2008].
- Use of very low power Radio Frequency devices or equipments including the Radio Frequency Identification Devices in the frequency band 50-200 KHz band with certain defined technical parameters such as Maximum Radiated Power or Field Strength limits etc. as mentioned in GSR 90(E) dated 10th February, 2009, has been exempted from licensing requirement [See also GSR 90(E) dated 10th February, 2009].

7. The request for the use of other bands for different services as indicated in NFAP-2008 shall also be considered on case to case basis.

EVOLUTION OF MOBILE TELEPHONY

Evolution is characterized by the transition from providing only analog voice to multimedia service (voice, video and data) as indicated by 1G to 4G systems as shown below:

1G (AMPS, NMT, TACS) : 1981

- Analogue voice transmission

2G (GSM, IS-54, PDC, IS-95) : 1991 - 95

- Digital Cellular
- Digital voice and low-speed circuit data (9.6 Kbps), SMS

2.5G (GPRS, CDMA One) : 1999 - 00

- Introduction of packet data
- Improved voice, medium speed CS and PS data (~100 Kbps), enhanced SMS

3G (WCDMA, EDGE, CDMA 2000) : 2002 - 03

- IMT-2000 requirements, Improved voice, high speed PS data (384Kbps - 2 Mbps)
- Improved spectral efficiency and capacity, Multimedia applications

3.5G (HSPA, 1xEV-DO, 1xEV-DV, WiMAX) : 2003 - present

- High speed packet data (2-14 Mbps)
- High Speed Downlink Packet Access (UMTS Rel 5)
- Based on a new high-speed downlink transport channel
- Provides peak data rates up to 14 Mbps
- Adaptive modulation (QPSK, 16QAM) and coding (AMC), Hybrid ARQ employed
- Eliminates variable spreading factors, fast power control
- Significantly reduced delay in assigning resources - rapid link adaptation
- Challenges Mixed mode traffic, receiver complexity

4G (LTE / LTE Adv, IEEE 802.16m) : 2010/11

LTE (Long Term Evolution), IEEE 802.16m

- High data rates

- Advanced Error Correction techniques (Convolutional Turbo Coding (CTC))
- Adaptive modulation and coding, Hybrid ARQ
- Advanced Antenna Techniques – 2x1, 2x2, up to 8x8
- Full MIMO and beam-forming support, Spatial multiplexing
- QoS - Supports different traffic types
- Efficient MAC design
- Fast and advanced scheduling (for DL and UL)
- Optimized ARQ
- Mobility - Secure optimized handover with < 50 msec break time
- Efficient power management - “Sleep mode” and “Idle Mode”
- Security - Advanced authentication and encryption
- End-to-end IP-based network

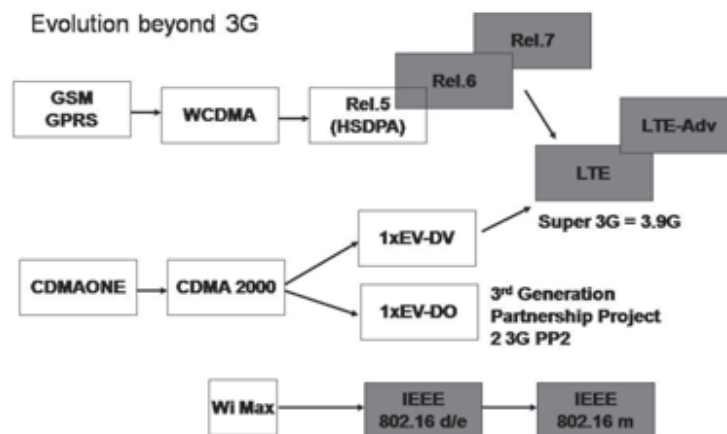

3.5G/4G – Focus on high data rates, spectral efficiency

AMPS	-	Advanced Mobile Phone System
EDGE	-	Enhanced Data rates for GSM Evolution
EV-DO	-	Evolution Data Optimised
EV-DV	-	Evolution Data Voice
GPRS	-	General Packet Radio Service
HSDPA	-	High Speed Downlink Packet Access
LTE	-	Long Term Evolution
NMT	-	Nordic Mobile Telephone
PDC	-	Personal Digital Cellular
TACS	-	Total Access Communication System
WCDMA	-	Wideband CDMA

TERRESTRIAL TRUNKED RADIO (TETRA)

1. Introduction

Driven by the need to overcome the difficulties faced by the emergency response teams from several European nations in communicating with each other, due in part to the lack of standardization in their mobile radio equipment, Terrestrial Trunked Radio (TETRA), an open standard for digital trunked mobile radio, was developed by the European Telecommunications Standards Institute (ETSI). Being an open standard, TETRA enables full interoperability between different independent manufacturer's products and hence it has also increased competition, provides second source security allowing a greater choice of terminal products for specific user applications.

All of the organisation that have been high-end users of private/professional mobile radio (PMR) or public access mobile radio (PAMR) technology viz Public Safety, Transportation, Utilities, Government and Oil & Gas etc have also been specifically benefitted by this open standard. This is especially true in the areas of law enforcement, disaster management and public safety, where fast and accurate field communications to and from a central office to the dispatchers are often critical.

It has a scalable architecture allowing economic network deployments ranging from single site local area coverage to multiple site wide area national coverage.

2. Tetra Radio Features

As a major step forward over PMR/PAMR, TETRA radio offers many new and valuable features that include (i) fast call set-up time, viz less than 300ms (which can be 150ms when operating in Direct Mode (DMO) between two mobile radios) which is shorter than the time taken by standard cellular tele-communication system and hence is of particularly importance for the emergency services, (ii) excellent group communication support, which are not possible in public cellular networks on GSM standard that are designed to support "one-to-one" calls through BTS, BSC, and MSC only (iii) direct mode operation between individual radios, in simplex manner for voice and data. (iv) packet data and circuit data transfer services, (v) better efficiency of frequency spectrum utilisation than the previous PMR radio systems (vi) advanced security features. (that may be essential for some covert operations or for the police services), (vii) scalable architecture allowing economic network deployments ranging from single site local area coverage to multiple site wide area national coverage and (viii) the system also supports a number of other features including call hold, call barring, call diversion, and ambience listening.

Some of the other special features of TETRA are further highlighted hereunder.

Open Interface Specifications

An important advantage of the TETRA standard is that it has a number of open interface specifications that can be used by application developers to further enhance the capabilities of TETRA. Similarly manufactures are able to provide (under license) details of their proprietary interface specifications in support of specific applications.

Priority Call

During network busy periods, priority call service allows access to network resources in order of user terminals call priority status. As there are 16 levels of priority in TETRA, this service is very useful in providing different Grade of Service (GoS) levels (and tariff structures) during busy periods. For example, front line officers would be provided with the highest priority levels in a Public Safety network to maintain the highest level of service access whilst routine users would be provided with lower priority levels.

Busy Queuing

In TETRA a queue is provided in the trunking controller during network busy periods to store and handle calls on a First In First Out (FIFO) basis in order of user priority level. The advantage is that a user only has to initiate a call request once, knowing that even in busy periods the call will be automatically established once a traffic channel becomes free, thus reducing user stress and frustration when contending with other users on a busy network.

Pre-emptive Priority Call

This call service, of which the highest priority is the emergency call, provides the highest uplink priority and highest priority access to network resources. If a network is busy, the lowest priority communication is dropped to handle the emergency call. The TETRA emergency call can be initiated by using a dedicated switch located on the terminal. Activating the emergency call automatically alerts the affiliated control room dispatcher and other terminal users in that persons talk group.

Dynamic Group Number Assignment (DGNA)

This service allows the creation of unique Groups of users to handle different communication needs and may also be used to group participants in an ongoing call. This service is considered by many public safety organizations to be extremely useful in setting up a common talk group for incident communications. For example, selected users from the Police, Fire and Ambulance could be brought together to manage a major emergency where close co-ordination between the three emergency services is required. Similarly, DGNA is also considered useful for managing incident by other user organizations such as Utilities and Transportation.

Ambience Listening

A Dispatcher may place a radio terminal into Ambience Listening mode without any indication being provided to the radio terminal user. This remote controlled action allows the dispatcher to listen to background noises and conversations within range of the radio terminal's microphone. This is an important service to utilize for those persons transporting important, valuable and/or sensitive material that could be 'hijack' targets. Similarly, this is a useful service to have implemented in public service vehicles where a driver's health and safety could be at risk.

Voice Encryption

The TETRA standard supports a number of over the air TETRA Encryption Algorithms (TEA's), the difference being the types of users who are permitted to use them. The main benefit of over the air encryption is that it can be implemented as software within radio terminals and base station equipment, instead of using encryption modules, which consume space and increase cost. The TETRA standard also supports 'end of end' encryption using a variety of other encryption algorithms as deemed necessary by national security organizations.

2.1 Technology Benefits

Essentially, most of the above advantages are derived from the core technologies used in the TETRA standard, viz **Digital, Trunking** and **Time Division Multiple Access (TDMA)**.

Digital

Even though analogue FM PMR communications will remain a viable option for several years, digital radio provides relative advantages and disadvantages in the important performance areas of, *Voice Quality, RF Coverage, Non-Voice Services, Security, Cost*

Trunking

The main benefit of trunking is **spectrum efficiency, i.e more radio users per RF brought about by the automatic and dynamic assignment of a small number of communication channels (shared amongst a relatively large number of users), compared with a conventional radio channel for a given Grade of Service (GoS)**, Trunking, thus helps reduce pressure on meeting PMR spectrum demands and hence preferred (because it allows several users to share a single frequency).

Time Division Multiple Access (TDMA)

TETRA operates in 400Mhz and 800 Mhz bands and it employs with 4 time slots, that can be judiciously used for concurrent transfer of voice and data by assigning one time slot for voice and next time slot for data to balance the cost of equipment with that of supporting services and facilities required by user organisations for a medium to high capacity network providing single site local RF coverage and/or multiple site wide area RF coverage. **The transmitter of each mobile station is only active during the time slot that the system assigns it for use. As a result, the data is transmitted in bursts.**

Also, the TDMA technology used in TETRA provides 4 independent communications channels in a 25 kHz RF bandwidth Channel, making it twice as efficient in occupied bandwidth terms as a traditional 12.5 kHz RF bandwidth FDMA channel (and hence higher data transfer rates for a given channel in TDMA). Although FDMA technologies tend to have a better carrier to interference (C/I) performance than TDMA TETRA, the overall spectrum efficiency advantage lies with TETRA, especially for medium to high capacity networks.

The data is modulated onto the carrier using differential quaternary phase shift keying. This modulation method shifts the phase of the RF carrier in steps of $\pi/4$ or $3\pi/4$ depending upon the data to be transmitted.

3. Modes of TETRA operation

There are three different modes in which TETRA can be run:

- **Voice plus Data (V+D)** is the most commonly used mode. This mode allows switching between speech and data transmissions, and can even carry both by using different slots in the same channel.
- **Direct Mode Operation (DMO)** is used for direct communication between two mobile units and supports both voice and data, **however full duplex is not supported in this mode. Only simplex is used.** This is particularly useful as it allows the mobile stations to communicate with each other even when they are outside the range of the base station.
- **Packet Data Optimised (PDO)** is the third mode where PDO is optimised for data only transmissions. It has been devised with the idea that much higher volumes of data will be needed in the future and it is anticipated that further developments will be built upon the TETRA mobile radio communications standard.

Annexures

Annexure 1

(refers to para 1.2.1 of Chapter 1)

DISASTER MANAGEMENT CONTINUUM

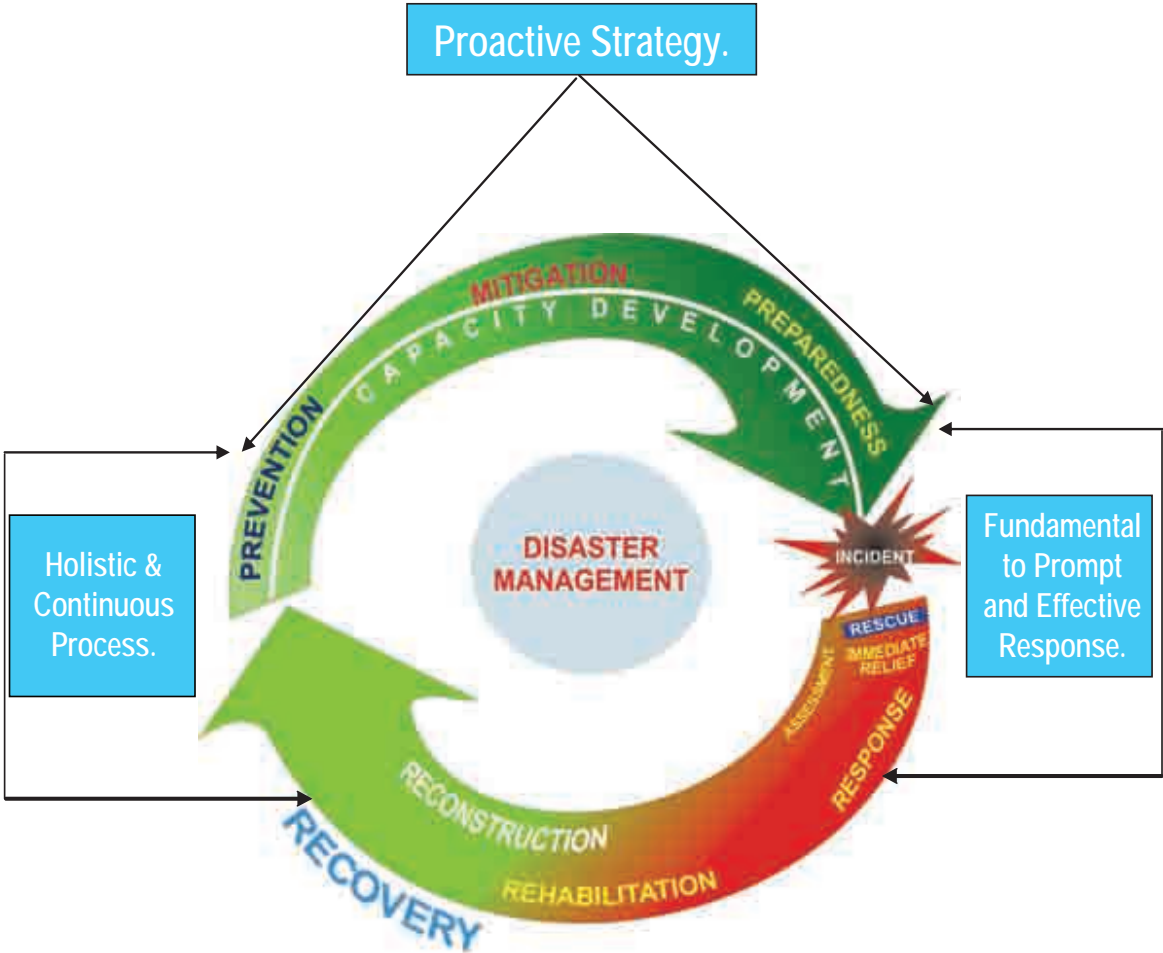

Annexure-2

(refers to 1.3 of Chapter 1)

MAJOR DISASTERS IN INDIA : 1990 - 2005

YEAR	PLACES	DISASTER	LOSS OF LIVES (APPROX)	LOSS OF PROPERTY (RS CRORE) (APPROX)
1991	UTTARKASHI	EARTHQUAKE	2000	2000
1993	LATUR	EARTHQUAKE	9500	6000
1997	JABALPUR	EARTHQUAKE	200	5000
1999	CHAMOLI	EARTHQUAKE	2000	2000
1999	ORISSA	S CYCLONE	9887	10000
TOTAL LOSSES DURING THE DECADE			23587	25000
2001	BHUJ	EARTHQUAKE	14000	13400
2004	SE INDIA	TSUNAMI	15000	10000
2004	ASSAM & BIHAR	FLOODS	700	5000
2005	J&K	AVALANCHE	350	100
2005	MAH, GUJ, HP, KARNATAKA, T'NADU	FLOODS	1569	10300
2005	J&K	EARTHQUAKES	1336	1000
TOTAL LOSSES DURING THE PERIOD			56542	64800

Annexure-3

(refers to Para 1..3 of Chapter 1)

MAJOR DISASTERS (1980-2008)

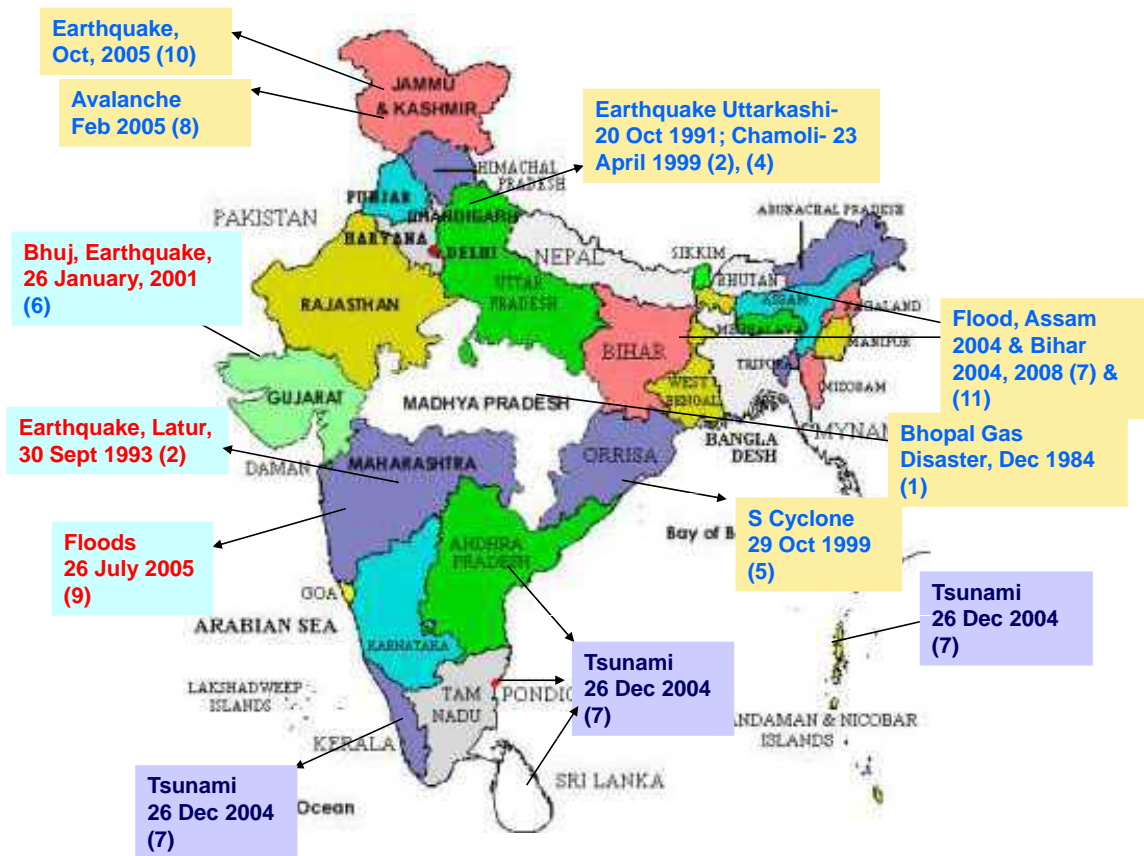

Annexure-4

Refer 1.3.1 of Chapter-1)

FLOOD HAZARD MAP OF INDIA

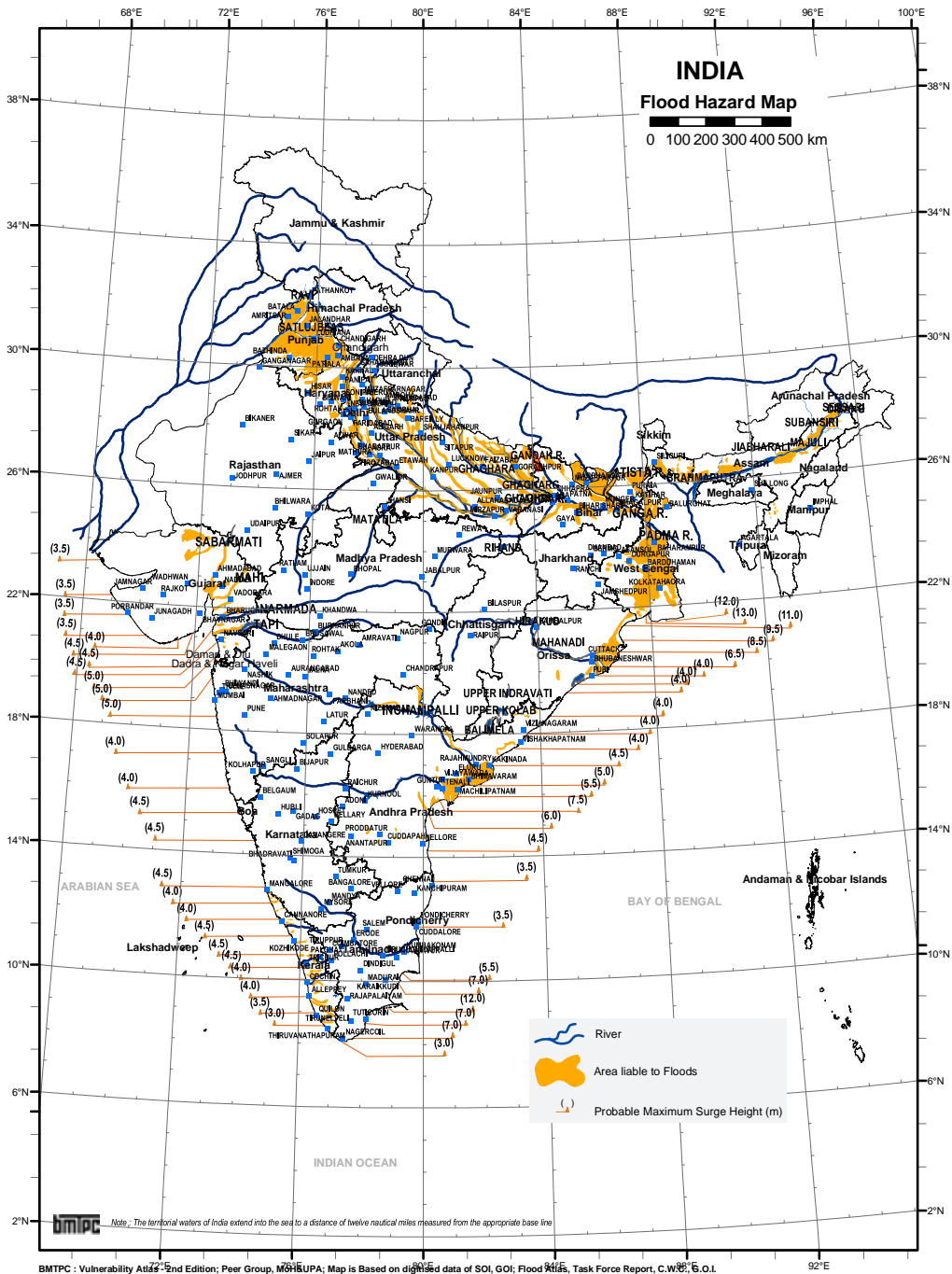

Annexure-5

Refer 1.3.2 of Chapter-1

CYCLONE AND WIND HAZARD MAP OF INDIA

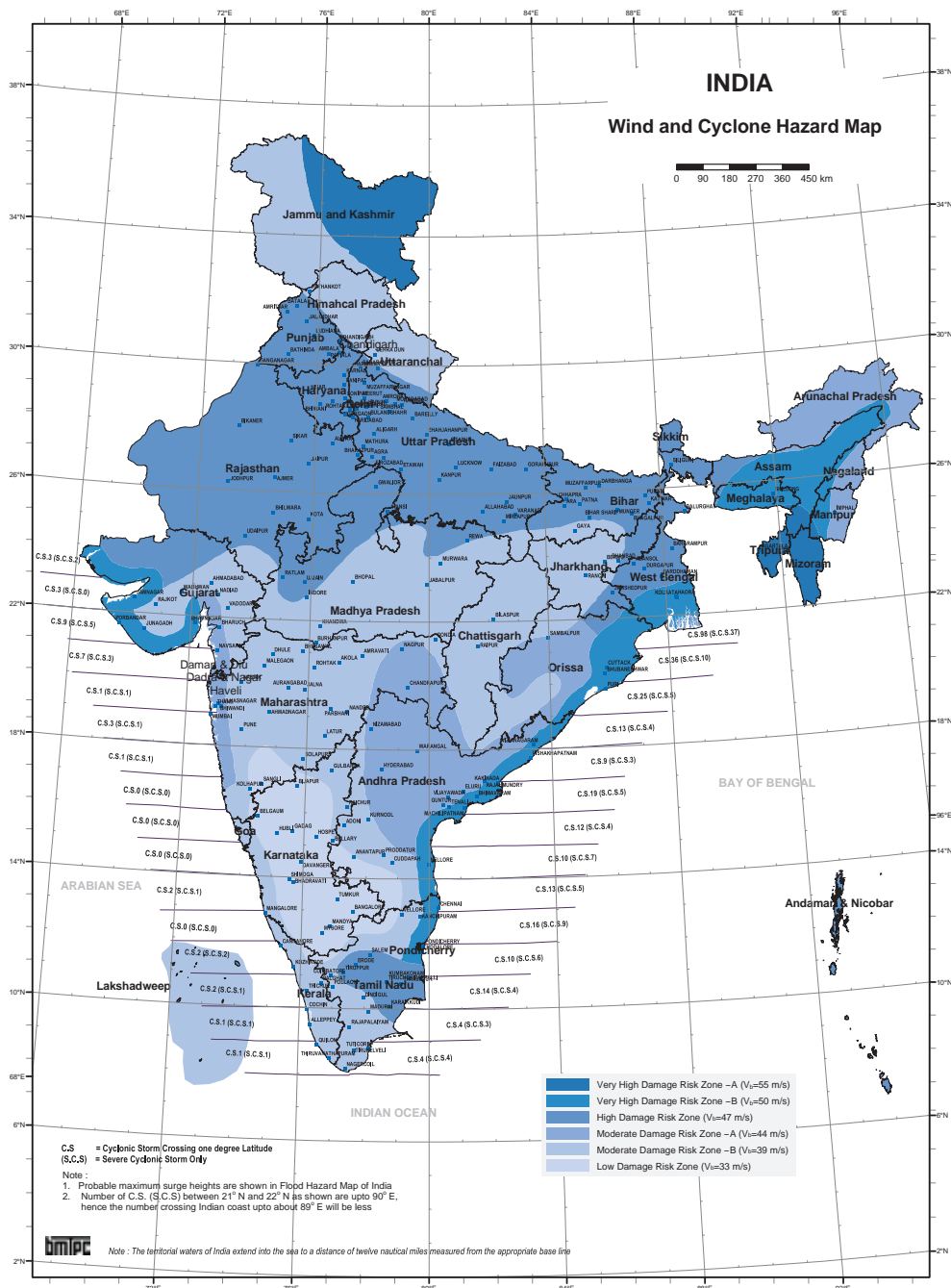

BMTPC : Vulnerability Atlas -2nd Edition; Peer Group, MoH&UPA; Map is Based on digitised data of SOI, GOI ; Basic Wind Speed Map, IS 875(3) -1987; Cyclone Data, 1877-2005, IMD, GOI

Annexure-6

Refer 1.3.3 of Chapter-1

EARTHQUAKE HAZARD MAP OF INDIA

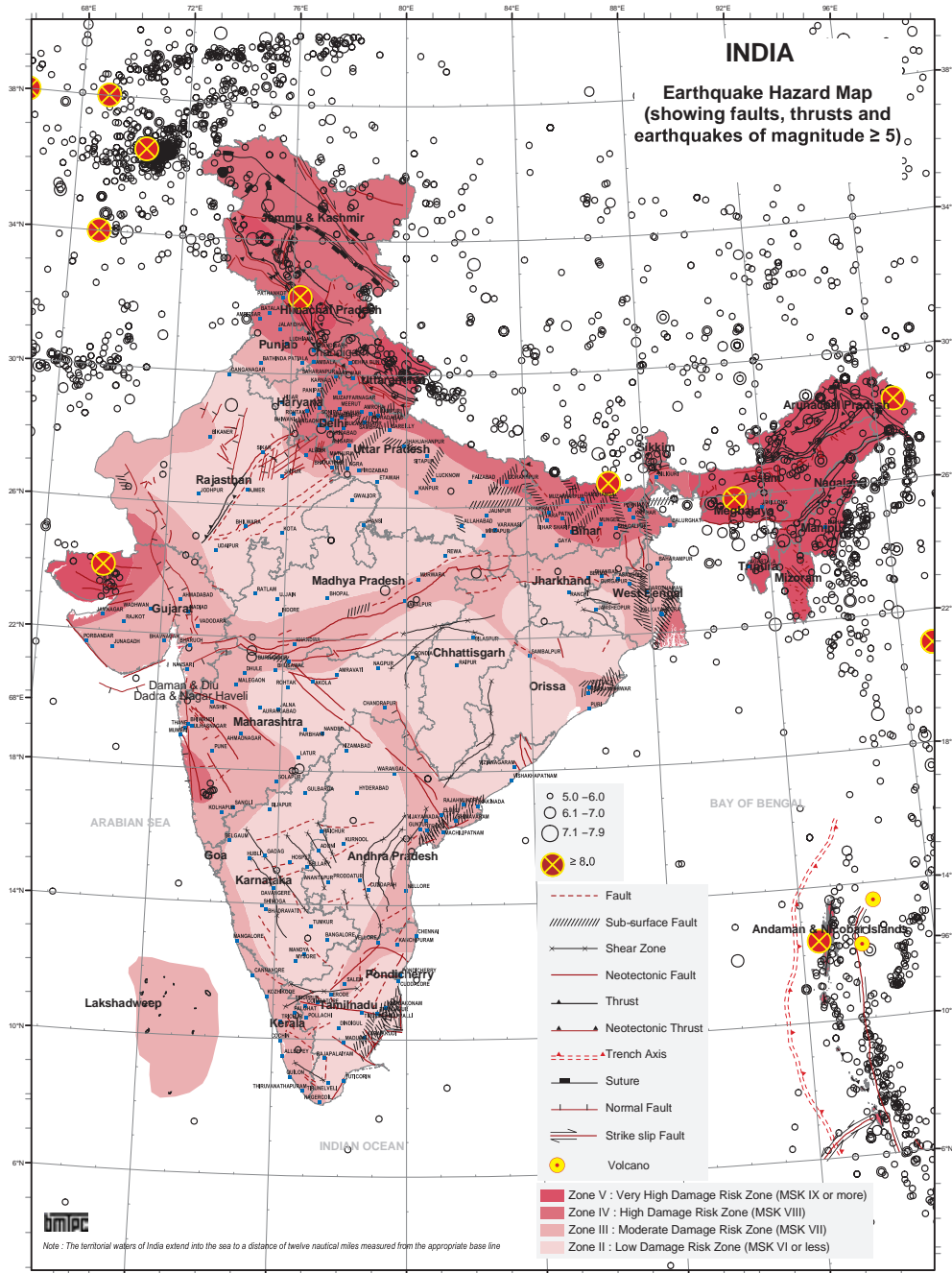

Annexure-6A

Refer 1.3.4 of Chapter-1

LANDSLIDE HAZARD ZONATION MAP OF INDIA

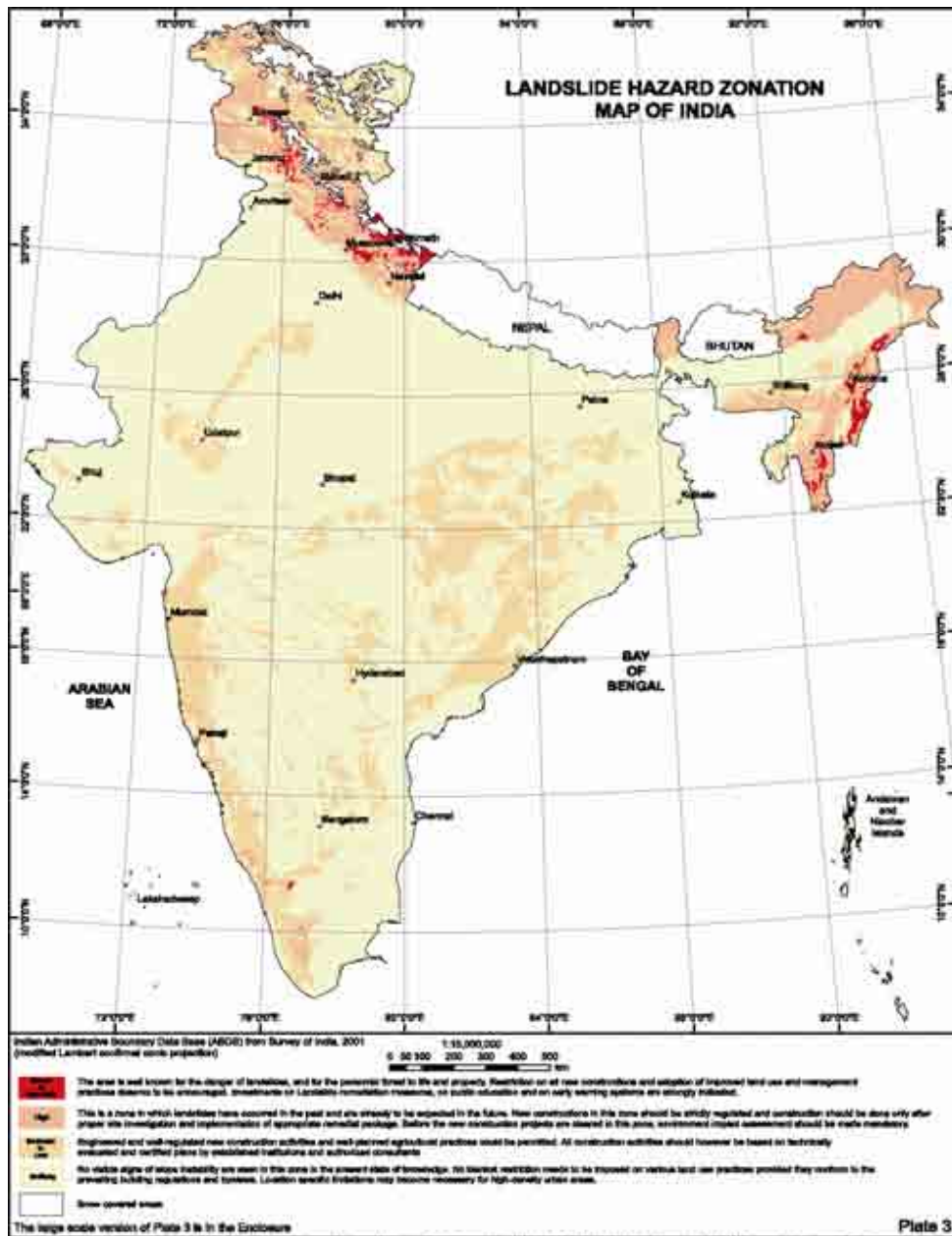

Annexure-7

(refers to Para 1.4 of Chapter 1)

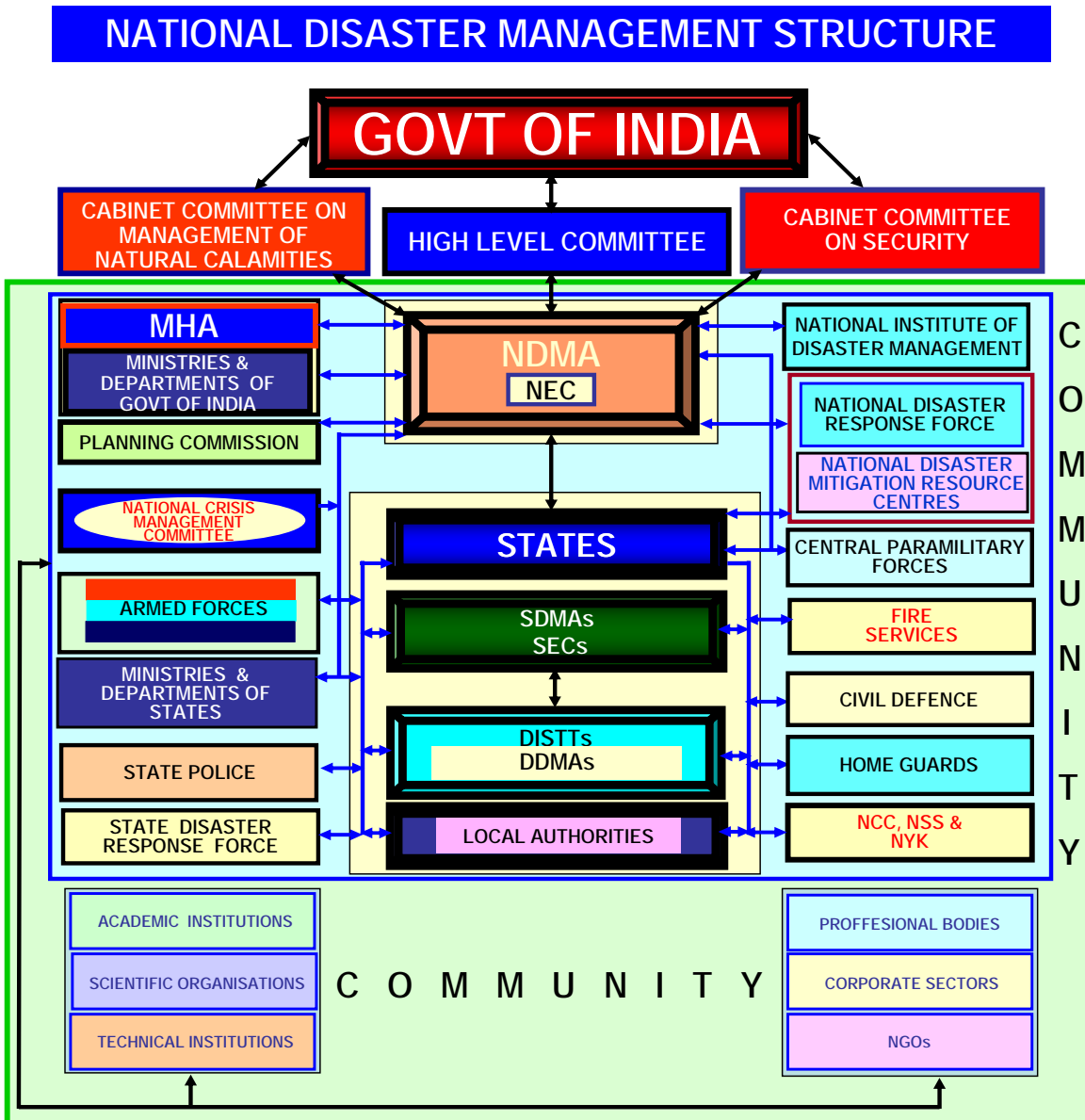

- Notes:
1. This diagram reflects interactive linkages for synergised management of disasters and not a hierarchical structure.
 2. Backward and forward linkages, especially at the functional level, are with a view to optimise efficiency.
 3. Participation of the Community is a crucial factor.

Annexure-8

(refer to 1.4 of Chapter 1)

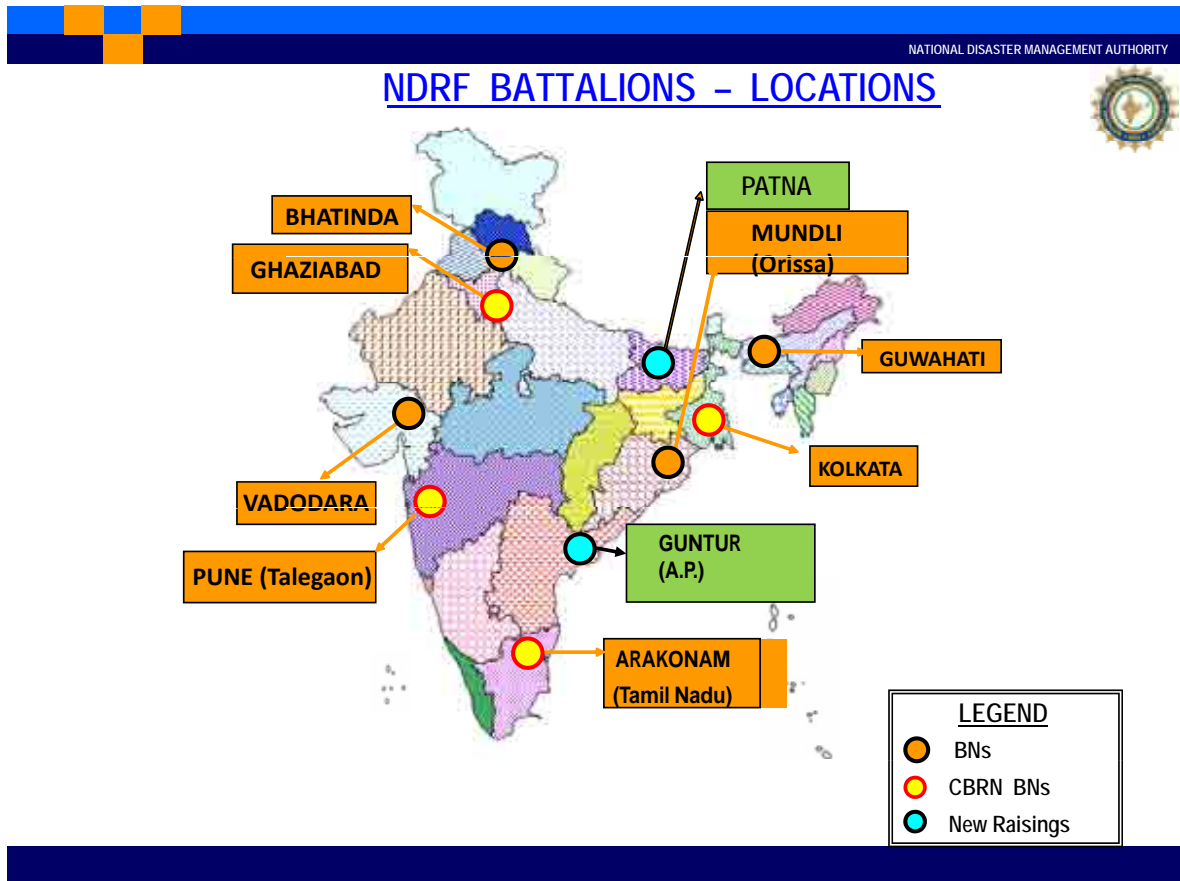

Annexure-9

(refer to 1.4 of Chapter 1)

**LIST OF EARLY WARNING & FORECASTING AGENCIES
REQUIRING DUE CONNECTIVITY**

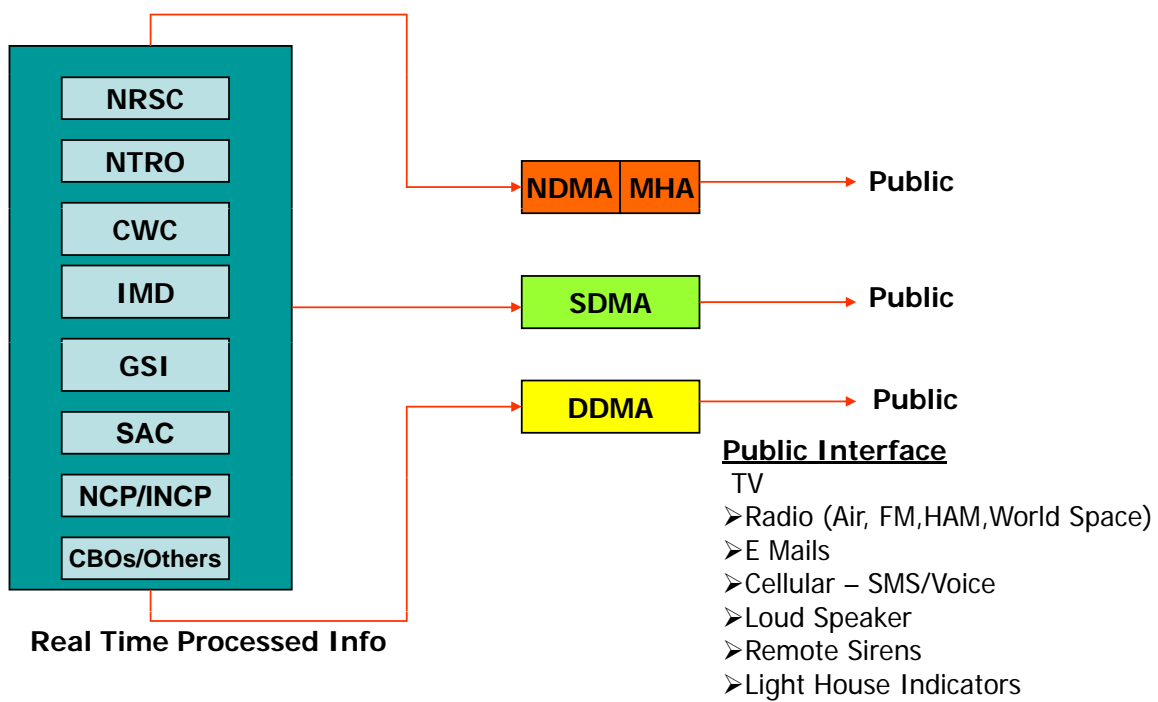

Annexure-10

(refers to 5.3 of Chapter 5)

CONVERGED & INTEGRATED COMMUNICATION CONNECTIVITY

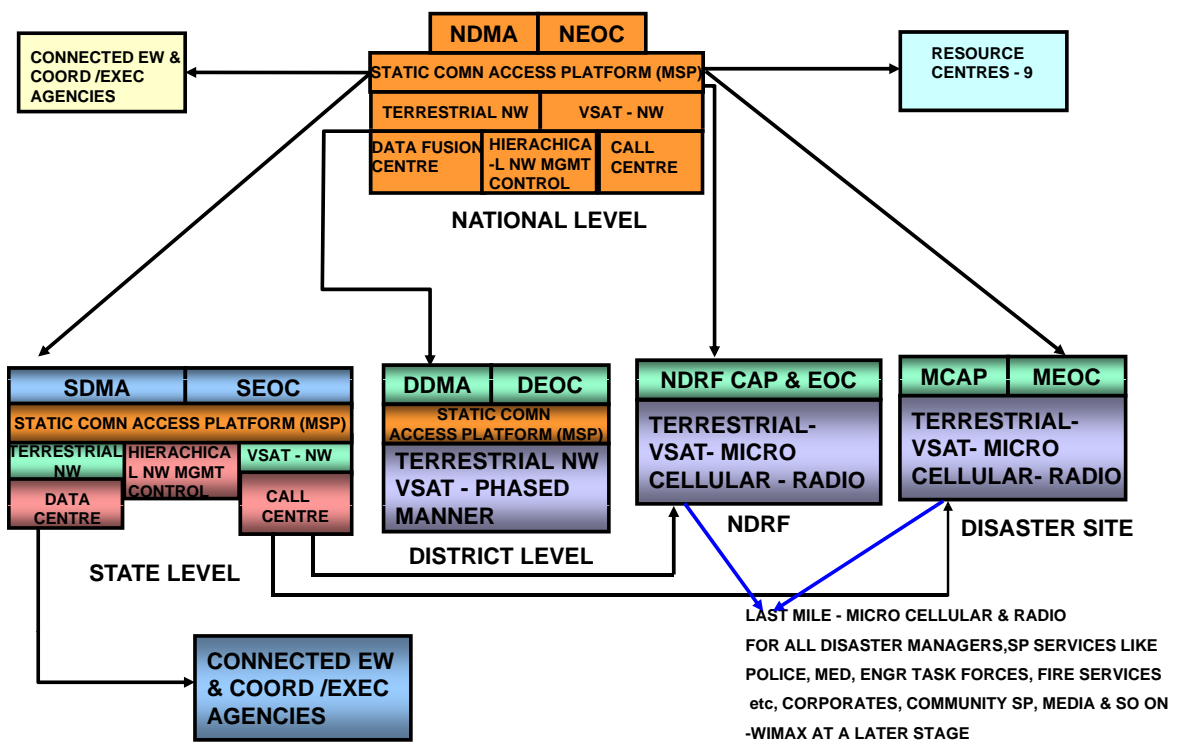

Annexure-11

(refers to 5.4 of Chapter 5)

COMMUNICATION & IT SUPPORT PLAN

INTEGRATED BASIC NETWORK – VOICE, VIDEO & DATA:

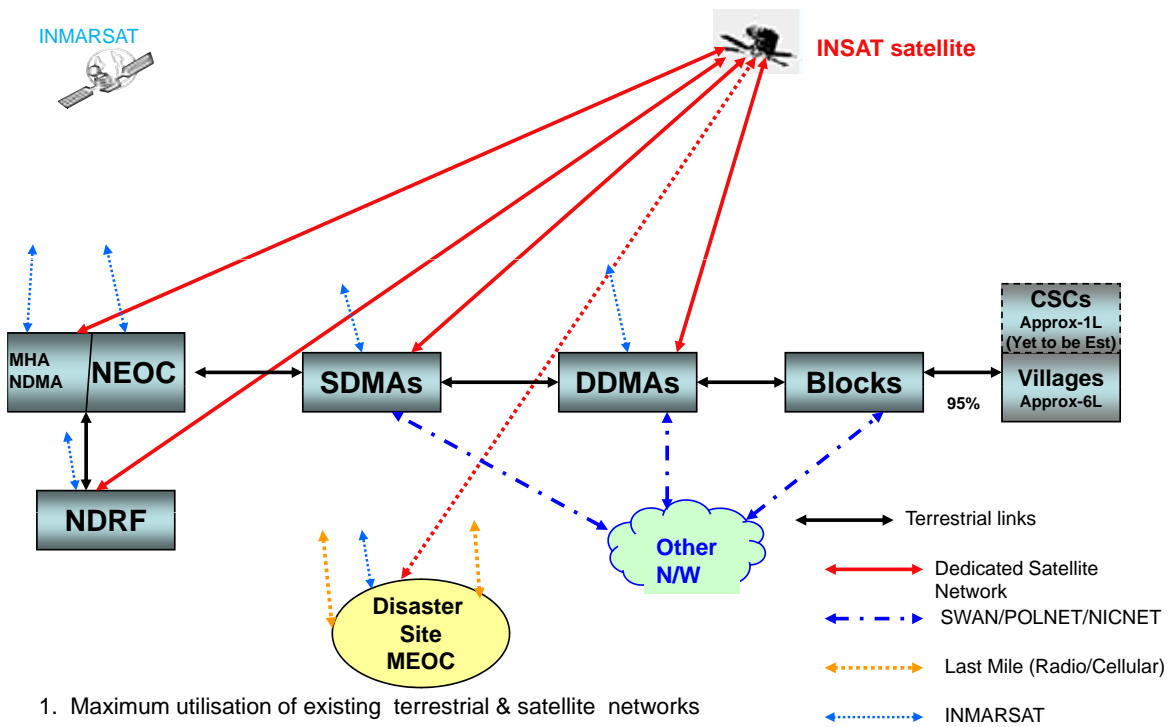

1. Maximum utilisation of existing terrestrial & satellite networks
2. Failsafe dedicated back-up satellite network & INMARSAT terminal

Annexure-12

(refers to 5.4 of Chapter 5)

INFORMATION ACCESS

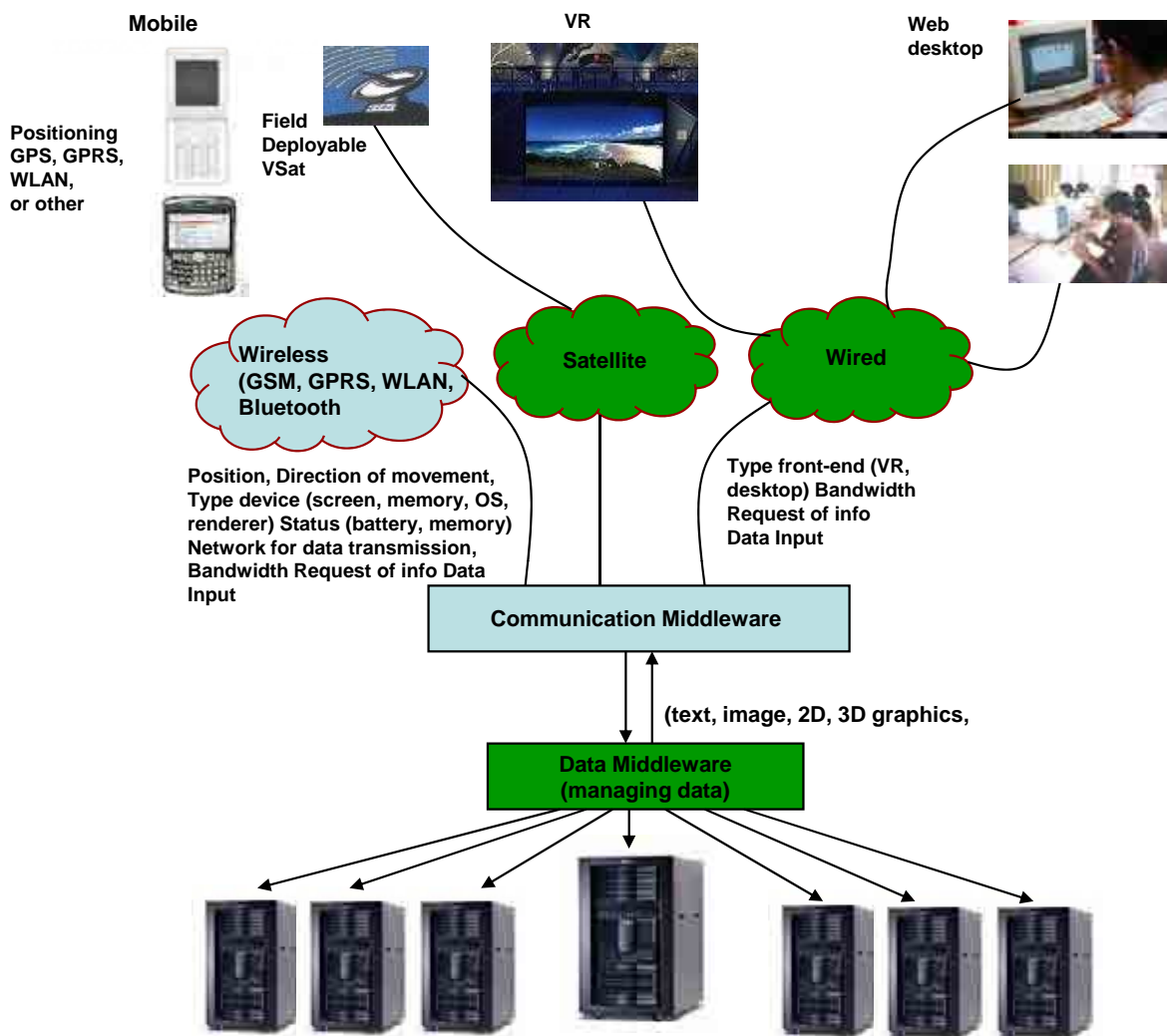

Annexure-13

(refer to 7.1 Chapter 7)

INFORMATION FLOW: EMERGENCY OPERATION CENTER (EOC)

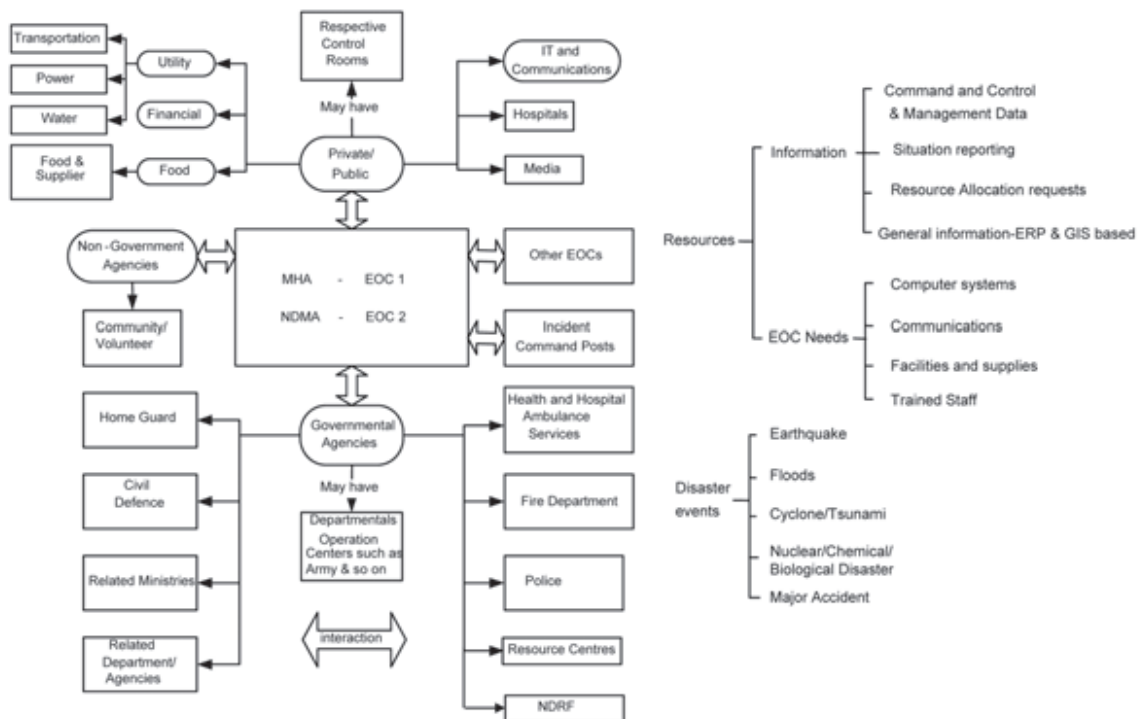

Annexure-15

(refers to 7.6.1 of Chapter 7)

COMMUNICATION EQUIPMENTS FOR NDRF AT DISASTER SITE

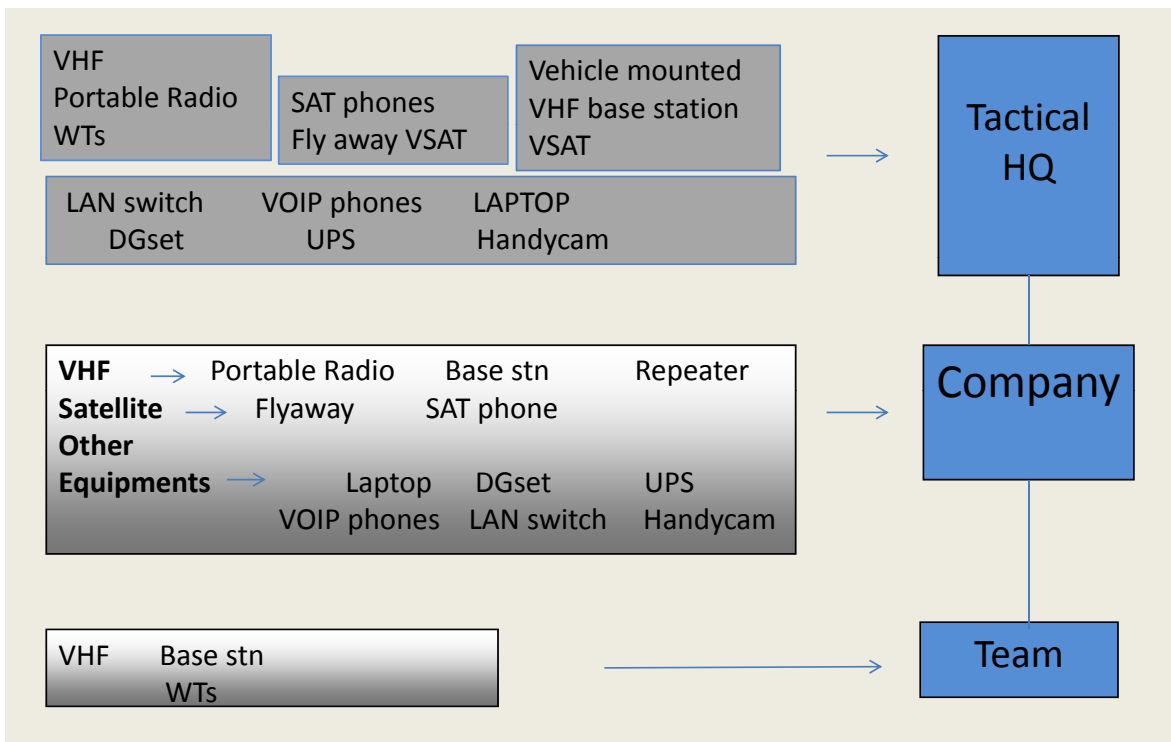

Annexure-16

(refer CH 7: para 7.6.1)

MEOC COMMUNICATION

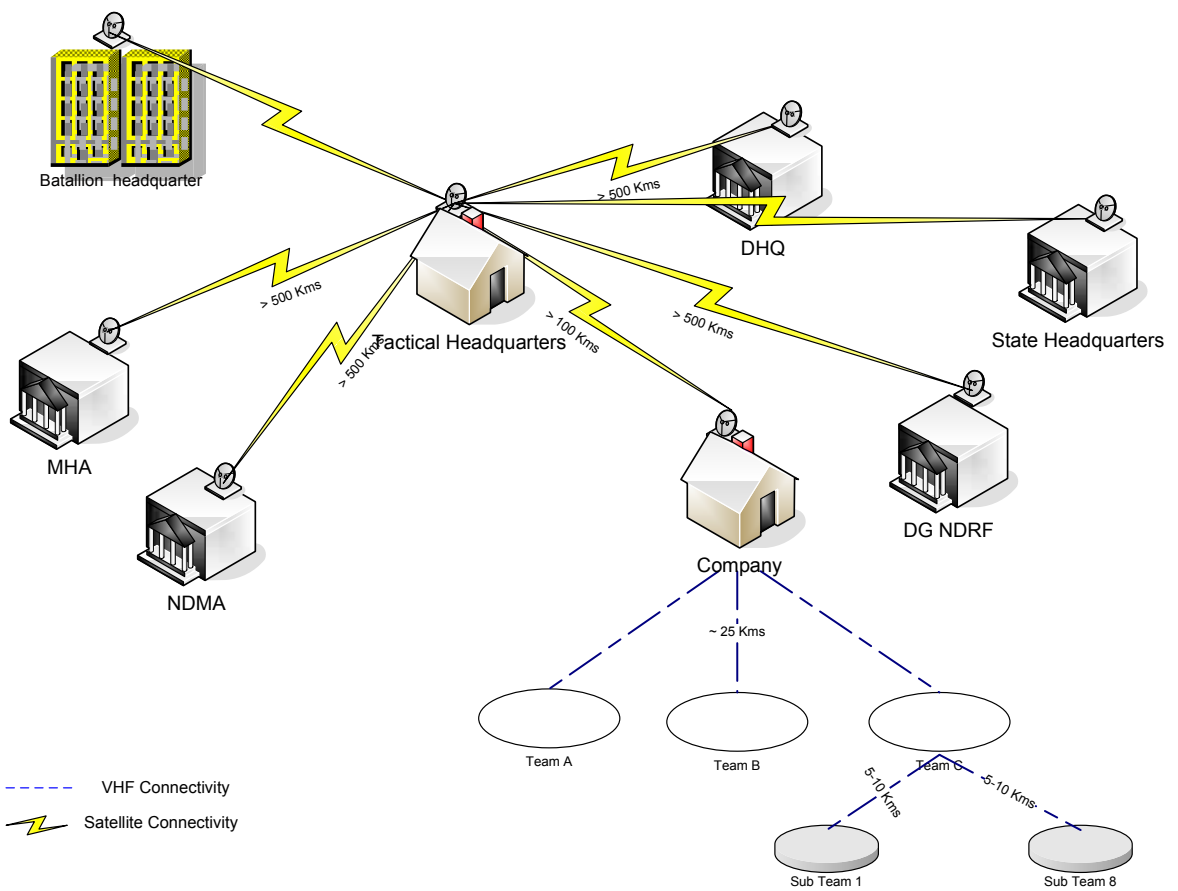

Annexure-17

(refers to 7.6.1 of Chapter 7)

NDRF REQUIREMENT AT SITE PER BATTALLION

Item	Team	Company	Tactical HQ	Total	Justification
1. Satellite based	-	-			
i) Satellite phone (INMARSAT BGAN/INSAT)	-	(1x6) = 6	2	8	Remark 1
ii) Transportable (Flyaway)VSAT (INSAT)	-	(1x6)=6	1	7	Remark 2
Vehicle mounted VSAT (INSAT)	-	-	1	1	
2. VHF					
Walkie-Talkie (WT) (5W)	10x3x6 =180	5x6=30	5	305 (215+90)	Remark 3
Base Station (25W) for WT	1x3x6=18	6x1=6	1	25	
Portable Radio*(25W)	-	6x1=6	1	7	Remarks 4
Repeater for wider coverage	-	1x6=6	-	6	
Other Equipments					
IP Phones with IP switch(to be connected to VSAT)	-	2 x6=12	10	22	
Laptop	-	(1x6)=6	2	8	
Handycam	-	(1x6)=6	1	7	
LAN switch**	-	(1x6)=6	2	8	
Genset	-	2KVA (1x6)=6	5KVA 1no	2KVA-6 nos 5KVA-1 no	
UPS(2KVA)	-	(1x6)=6	1	7	
Specially built transportable vehicle (ready to use)			1	1	
**for connecting Laptop/Handycam output to VSAT					

Remark 1: INMARSAT terminal provide immediate reliable communication from the disaster site and does not depend on last mile connectivity. It will be used till flyway VSAT is installed. Also it can be deployed to send pictures of the disaster from a handycam

Remark 2: Quickly deployable (within 15 minutes) flyaway VSAT can establish high bandwidth communication for voice, video and data on a regular basis. This would also act as redundant unit to vehicle mounted VSAT (which may take a bit longer time to set up)

Remark 3: Provide communication among the NDRF staff and also for local authorities : (For authorities: $5/\text{team} \times 3 \times 6 = 90$). It has been decided to adopt VHF system to overcome some of inherent weaknesses of HF system (< 30 Mhz) like instability, poor signal strength and non-availability of signal within skip-distance

Remark 4: can be fitted on vehicles provided by State Govt/hiring

Headquarters (Base camp) Per Battalion

i. Work Stations	3
ii. LCD Panels	2
iii. Cable TVs with LCD Monitors	2
iv. Dish TV	2
v. 25 lines EPAX	1
vi. IP phones	2
vii. VSAT satellite terminal	1
viii. INMARSAT satellite phones	2
ix. Mobile handsets with CUG (Closed User Group) connection: (8 /team, 2/company, 4 for THQ) i.e. $(8 \times 3 \times 6) + (2 \times 6) + 4$	160 (@ note)
x. LAN switch	1
xi. Genset 10KVA	1
xii. UPS 8 KVA	1

Other Peripherals

i. Fax Machines	1
ii. Scanner	1
iii. Photocopier	1
iv. Laser Printer	1

@ Note: Mobile handsets are required to call the NDRF staff while mobilizing the force at Battalion headquarters by sending messages on cell broadcast using CUG (Closed User Group) connection.

Core Group Members

1.	Shri B.Bhattacharjee	Hon'ble Member NDMA New Delhi	Chairman
2.	Shri P. Ganesh	Senior Specialist , NDMA New Delhi	Convener
3.	Shri N.K. Srivastava	Senior DDG, Telecom Engineering Center, Department of Telecommunications, New Delhi	Member
4.	Shri D.P. Singh	Joint Secretary, Min of Earth Science, New Delhi	Member
5.	Shri A.S. Durai	Head, Ahmadabad Earth Station, Space Application Center, Ahmadabad	Member
6.	Dr. P.S. Dhekne	Associate Director, Electronics & Instrumentation Group. Bhabha Atomic Research Center Mumbai	Member
7.	Dr. Govind	Senior Director Department of IT New Delhi	Member
8.	Mr. Mukesh Kumar	Department of IT New Delhi	Member
9.	Shri U.K. Srivastava	Deputy Director General (SAT), Telecom Engineering Center, Department of Telecommunications New Delhi	Member
10.	Dr. B.K.Gairola	DG NIC, Department of IT New Delhi	Member
11.	Dr. M.S. Rao	Senior Tech Director, Department of IT New Delhi	Member

12.	Shri T.V. Partha Saradhi	Director (Communications), IT Dept Government of Andhra Pradesh, Hyderabad	Member
13.	Shri Kamal Lochan Mishra	Deputy. Gen. Manager III, Disaster Mitigation Authority, Orissa	Member
14.	Shri P.M. Dastidar	IGP (Communication), Ulubari, Guwahati, Assam	Member
15.	Shri R Madhavan	Senior Manager, Electronics Corp of Tamil Nadu Ltd, Chennai	Member
16.	Prof. Chandan Mazumdar	Head, Computer Science & Engg Department, Jadavpur University, West Bengal	Member
17.	Lt. Col. Sachin Burman (Retd)	Head, NST, NTRO New Delhi	Member
18.	Dr. Ashok Chandra	Wireless Adviser, Dept of Telecom, New Delhi	Member
19.	Shri V. Bhanumurthy	National Remote Sensing Center (NRSC), ISRO Hyderabad	Member
20.	Maj. Gen. Subhash Chander (Retd)	Gurgoan New Delhi	Member
21.	Dr. G.S. Mandal	Sr. Specialist, NDMA New Delhi	Member

Contact Us

For more information on these Guidelines on *National Disaster Management Information and Communication System (NDMICS)*

Please contact:

Shri. B. Bhattacharjee

Member

National Disaster Management Authority
NDMA Bhawan, A-1 Safdarjung Enclave
New Delhi-110 029

Tel: +91 11 26701780

Fax: +91 11 26701808

Email: bcharjee@gmail.com

Web: www.ndma.gov.in